

SEPTEMBER 1979

\$3.00

BMME

BROADCAST MANAGEMENT/ENGINEERING

THE SOURCE

THE VERIFIED BUYER'S GUIDE

0892-7225-00-0-7741 A<1
-40
WA WASHINGTON
98195

BROADCAST EQUIPMENT / VIDEO EQUIPMENT / FILM
RECORDING EQUIPMENT / STUDIO EQUIPMENT / SET
DESIGN / SOUND RECORDING / RECEIVING EQUIP
MENT / TRANSMISSION TOWERS / TRANSMISSION
RECORDING EQUIPMENT / MONITORING / TIMING / LO
CAL AREA NETWORKS / SERVICES / COMPONENTS
RECORDING SYSTEMS / AUDIO EQUIPMENT /

SS 8650

STEREO AUDIO CONSOLE



A new standard modular audio console offering full facilities, quality circuitry of proven reliability, comprehensive features and a range of standard, pre-wired options. A maximum of fourteen channels are available along with a convenient centrally-located script board and input and accessory modules to satisfy any requirement. Standardization allows these features to be incorporated into a well engineered, compact, functionally styled package at an unusually economical price.



MCCURDY RADIO INDUSTRIES

TORONTO
[416] 751-6262

CHICAGO
[312] 640-7077

NEW YORK
[201] 327-0750

Circle 100 on Reader Service Card



Jane Kaelber
Drum Alignment
5 years



Velma Cowan
Tip Winding
8 years

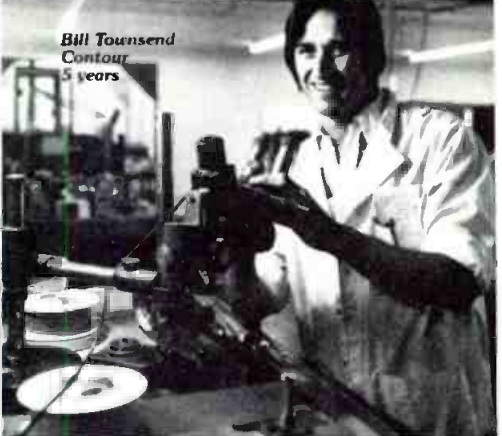

Bill Townsend
Contour
5 years



Patricia White
Tip Inspection
6 years

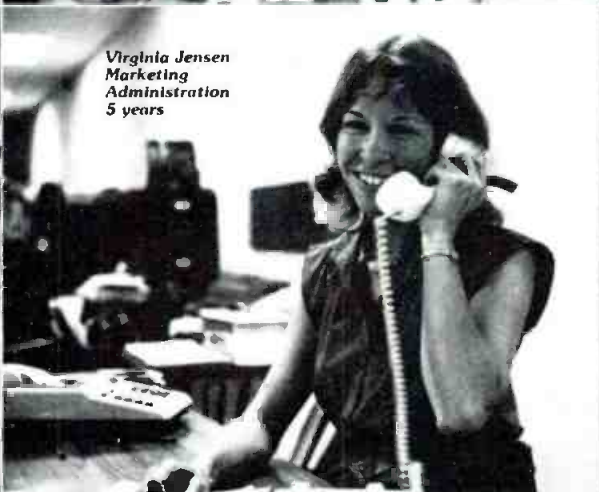

Virginia Jensen
Marketing
Administration
5 years



Pat Ladoga
Assembly
6 years

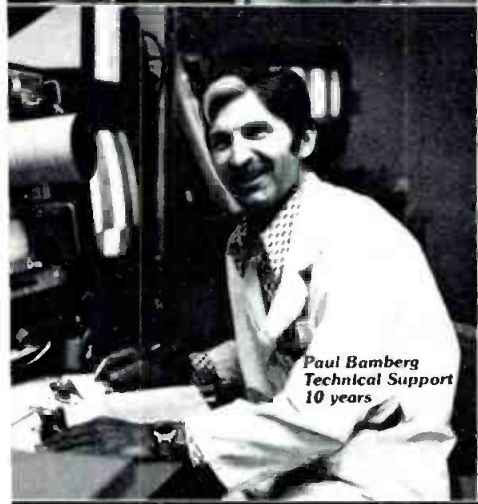

Paul Bamberg
Technical Support
10 years



Rose Underwood
Preliminary
Quadrants
10 years

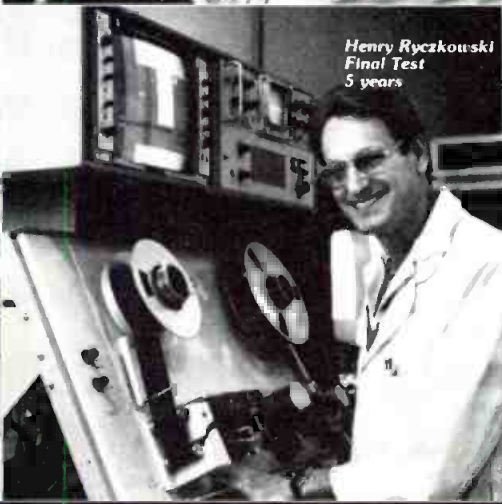

Henry Ryczkowski
Final Test
5 years

Put your heads in the most capable hands in the industry.

Our Years of Technical Expertise Have Made Us The World's Largest Independent Head Refurbisher

Over 10 years and 18,000 video heads ago, we decided we were going to be the leading independent in quad head refurbishing. To accomplish this, we knew we had to do things better than Ampex and RCA. Our location in the center of U.S. video technology made it possible for us to put together a marvelous marriage of people and technology. It also made it possible for us to achieve our goals.

Many of our technical experts and production people have been with us from the beginning. It's people like this, with their special skills, who put their heads together to provide over 1,000 customers all over the world with the most technically perfect refurbished video heads and the finest service support anyone could possibly ask for.

To learn how our experience can help you keep your quads in top shape, write or call, VIDEOMAX, 3303 Scott Boulevard, Santa Clara, CA 95050, (408) 988-2000, Telex: 910-338-0554. Los Angeles (213) 980-7927, New York (212) 947-8031, Atlanta (404) 992-4490.

Sales and service representatives in Canada, Australia, Hong Kong, Argentina, Mexico, Japan and Germany

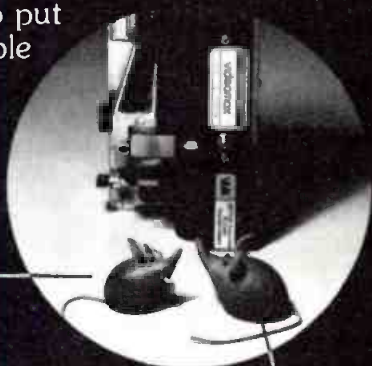

Max:
"My goodness,
all those people
to do just
one job?"

Maxine:
"That's only
a small part.
There are
nearly fifty
altogether."

videomax ORROX

Circle 101 on Reader Service Card

**“FINALLY THERE’S A ONE-INCH
AS WELL UPSIDE DOWN**



VIDEO RECORDER THAT WORKS AS IT DOES RIGHT SIDE UP."

DAVID HALL / OPRYLAND PRODUCTIONS

Opryland Productions is one of the largest video production houses east of the Mississippi. The company's facilities have been used for shows as varied as "Nashville on the Road," "Big Ten Basketball," and "Dance in America."

David Hall, General Manager of Opryland Productions, has been using the Sony BVH-1000 video recorder for close to two years and two BVH-500 portable recorders for about six months.

"Sony one-inch equipment has expanded our capabilities considerably," says Hall. "With a BVH-500, we were able for the first time to get broadcast quality tape on a roller coaster for an upcoming special.

"We also took the BVH-500 on a ferris wheel and in a helicopter to tape 'Superstars at the Ohio State Fair.' It performed as well as they did.

"Now we're using Sony on almost all shows we tape in the field. The big advantages are portability and cost. Durability, too. Sony even bailed us out when we were taping a quad production and our equipment broke down. We used Sony to finish the job, then transferred the results to quad. The client was more than satisfied.

"And when the Dominican Republic asked us to tape the visit of Pope John Paul II, we couldn't have done it without our Sony video recorders," Hall adds.

"Because they travel so well, we could get down there fast and do a professional job."

Of course, Sony makes a full line of one-inch broadcast equipment, all of it backed by state-of-the-art technology. We have video recorders, cameras, editors, and the BVT-2000 digital time base corrector.

For information, write Sony Broadcast, 9 West 57th Street, New York, N.Y. 10019. Or call us in New York at (212) 371-5800; in Chicago at (312) 792-3600; or in Los Angeles at (213) 537-4300.

Like David Hall at Opryland, you'll be impressed. Even if your productions don't have you going around in circles.

SONY BROADCAST

Sony is a registered trademark of Sony Corp.

Circle 102 on Reader Service Card

www.americanradiohistory.com

BM/E

BROADCAST MANAGEMENT/ENGINEERING

SEPTEMBER 1979/VOLUME 15/NUMBER 9



The industry's most reliable guide to broadcast equipment. Whatever you need for broadcasting, you'll find it in *The Source*.

8 Broadcast Industry News

AKO may lose broadcast license; Zenith blasts TI's experimental receiver; NRBA meet to focus on radio's changing needs

26 Radio Programming & Production For Profit

Serve the weather straight or with the flavor of your choice

28 BM/E's Program Marketplace

Profile of WCRB Productions, Inc.

35 Television Programming & Production For Profit

WHIO's Battle of Gettysburg: low-budget production wins audience and recognition

41 WRBR-FM Brew UP An Exciting New Broadcast Facility

A 125-year-old brewery provided the basis for the station's new home

49 Rehab Tax Bonus

Uncle Sam will pick up part of the tab for rehabilitating your old station or studio

59 Television Demodulator Proof-Of-Performance

Follow these procedures to establish your demodulator's quality of performance

67 THE SOURCE

68 Instant Source Locator

Ten categories and over 300 subcategories of broadcast equipment and who makes it

89 Broadcast Equipment Manufacturers

Names, addresses, telephone numbers, product descriptions for hundreds of manufacturers. It's verified!

161 Independent Broadcast Reps/Distributors

All major reps/distributors organized by state

198 FCC Rules and Regulations

Are your commercials legal?

201 Great Idea Contest

Win a calculator - enter the Great Idea Contest

205 Broadcast Equipment

BM/E's survey of new products

BROADBAND INFORMATION SERVICES, INC.
295 Madison Ave., New York, N.Y. 10017, 212-685-5320, Telex: 644-001
Publishers of: **BM/E—Broadcast Management/Engineering**
BM/E's World Broadcast News

★**ABP** **mcc**

VBPA BM/E BROADCAST MANAGEMENT ENGINEERING (USPS 059280) is published monthly by Broadband Information Services Inc. All notices pertaining to undeliverable mail or subscriptions should be addressed to 295 Madison Ave., New York, NY 10017. BM/E is circulated without charge to those responsible for station operation and for specifying and authorizing the purchase of equipment used in broadcast facilities in the U.S. and Canada. These facilities include AM, FM and TV broadcast stations, CATV systems, ETV stations, networks and studios, audio and video recording studios consultants, etc. Subscription prices to others \$24.00 one year, \$36.00 two years, Foreign \$30.00 one year, \$48.00 two years. Air Mail rates on request. Copyright 1979 by Broadband Information Services, Inc., New York City. Controlled circulation postage paid at East Stroudsburg, PA.

Publisher
Charles C. Lenz, Jr.
Editorial Director
James A. Lippke

Editor
David Hawthorne
Senior Editor
Robin Lanier
Senior Editor
Robert Rivlin
Assistant Editor
Eva J. Blinder
Creative Director
Gus Sauter
Manager
Publication Services
Djuna Van Vort
Production Manager
David Rose
Advertising Production
Deborah Foley
Comptroller
Joseph W. Kutner
Reader Service
Ann Liewellyn
FCC Counsel
Lovett Ford and Hennessey, P.C.

GRASS VALLEY GROUP 

QUALITY

TERMINAL

EQUIPMENT

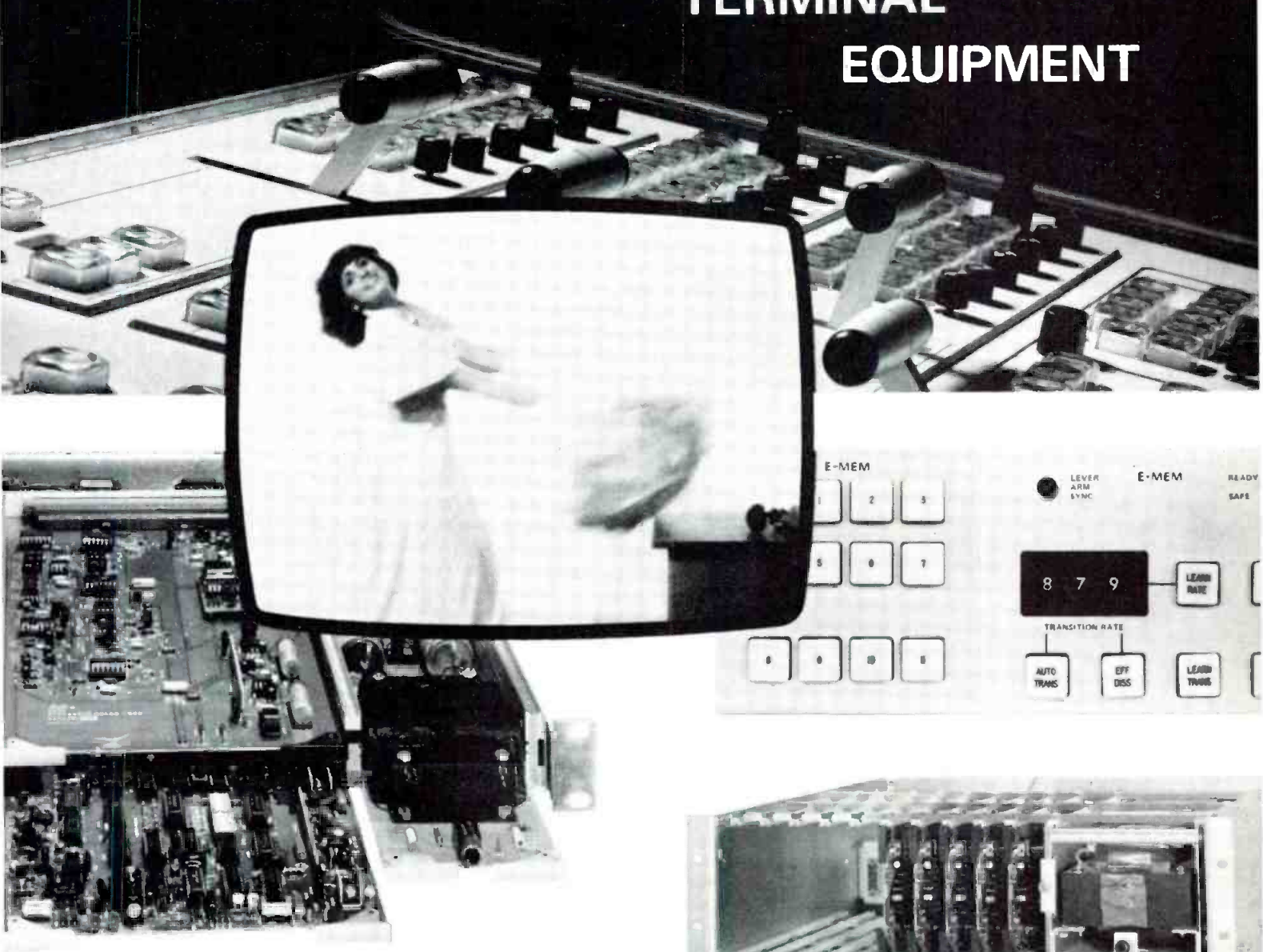

Grass Valley Group's range of television terminal equipment is the broadest in the industry, from distribution amplifiers, sync generators and video processors to large production switchers and audio/video assignment matrices.

Since Grass Valley Group manufactures a *complete* range of products, customers can be confident that equipment will perform in a system as well as on an individual basis.

All Grass Valley Group products are supported by a worldwide two-year warranty.

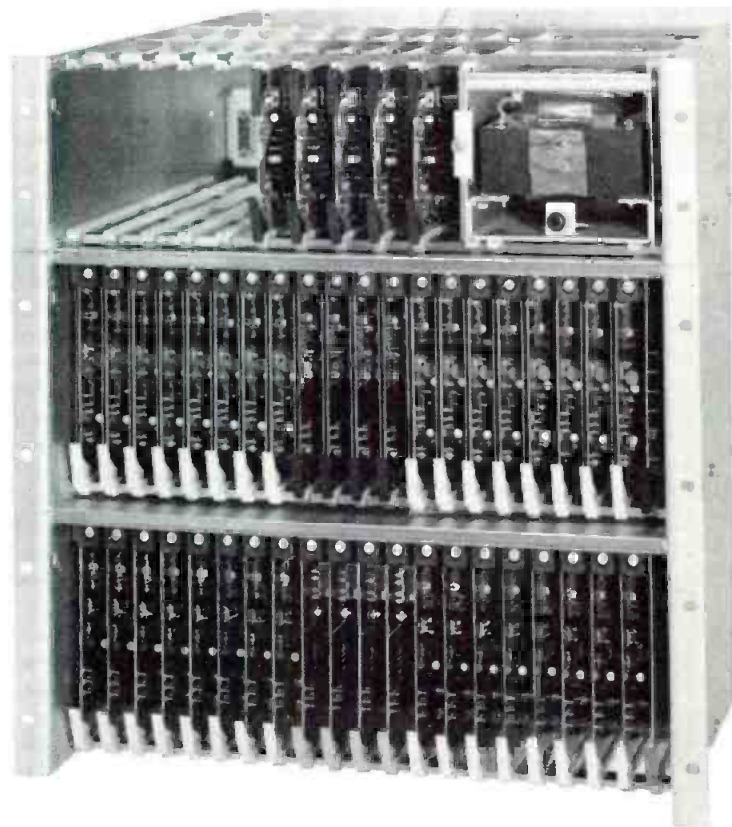

THE GRASS VALLEY GROUP, INC.

A TEKTRONIX COMPANY

Grass Valley Group Field Offices: WEST: 4419 Van Nuys Blvd Ste 307, Sherman Oaks, CA 91403 (213) 990-6172 • SOUTHEAST: 1644 Tullie Cir NE, Atlanta, GA 33029 (404) 21-4318 • NORTH CENTRAL: 810 W Bristol St, Elkhart, IN 46514 (219) 264-0931 • NEW ENGLAND & MID ATLANTIC: Station Plaza East, Great Neck, NY 11021 (516) 37-1311 • SOUTHWEST: 2639 Walnut Hill Ln Ste 143, Dallas, TX 75229 (214) 358-4229 • MIDWEST: 3585 N Lexington Ave Ste 374, Arden Hills, MN 55112 (612) 483-2594

Circle 103 on Reader Service Card

www.americanradiohistory.com

BROADCAST INDUSTRY NEWS

RKO May Lose Broadcast License

The misdeeds of its parent company may jeopardize RKO General's title to WNAC-TV, Boston, and possibly its three other television and 12 radio stations. RKO is in danger of being judged unqualified to hold the WNAC license because General Tire, RKO's owner, has admitted making foreign payoffs and illegal campaign contributions, as well as other illegal actions.

A preliminary announcement by the

FCC July 18 stated that the Commission "could not find RKO General qualified to be the licensee of WNAC-TV." The Commission then met for two days to decide whether to immediately declare RKO unqualified or to hold more hearings. These meetings ended with the panel studying the matter allowing RKO 30 days to submit evidence that it should be allowed to keep the license.

Complicating the issue is RKO's desire to sell WNAC. The prospective buyer was New England Television

Corp., made up of two companies that had filed separate challenges to the license based on General Tire's illegal activities. The sale will be held up until a decision is reached.

If the FCC finds against RKO in this case, the company's remaining broadcast properties would be subject to similar action. The stations include WOR-TV, New York, KHJ-TV, Los Angeles, WHBQ-TV, Memphis, and radio stations in New York, Los Angeles, Chicago, Boston, and Washington.

Comsat Direct To Home Pay-TV Proposed



The Comsat direct-to-home terminal might consist of a small dish and decoder like those pictured

The federally chartered Comsat Corp. proposes to have in place as early as 1983 a pay-TV service via a direct to home satellite transmission scheme.

This proposal from Comsat is already knocking the regulatory framework into a cocked hat. The service, which will provide movies, sports, educational, and other services for a fee to the home viewer, raises serious questions about jurisdiction, the status of Comsat, and the impact such a system might have on other services. When Comsat presents its formal filing to the FCC in 3 to 4 months, both the Common Carrier and Broadcast bureaus are expected to assert jurisdictional claims. If the new service comes under the purview of the Broadcast Bureau, it is conceivable, according to one FCC official, that "we could end up

being asked to have hearings on its impact on every single TV market in the country." Nevertheless, FCC chairman Charles Ferris expressed a favorable attitude towards the proposal and said he did not want the Commission to be an obstacle to the expanding choice of video services.

Reaction to the proposal from broadcast and cable TV organizations was cautious. The service which would offer 2 to 6 channels of programming over the 12 GHz band would likely have the greatest impact on other pay services and cable TV which has experienced its greatest growth through its pay TV offerings. Cost for the terminal might be around \$400 and the monthly fee could probably be about \$25 for the programming and terminal maintenance.

Zenith Blasts TI's Experimental Receiver

A "high-performance" TV receiver designed by Texas Instruments under contract with the FCC was criticized by Zenith Corp. and other manufacturers for offering what they called a poor cost/benefit ratio.

Terming TI "totally inexperienced in engineering, design, and mass production in this field," Zenith told the Commission, "There is no basis for assuming that [the receiver] is an optimum, or even a viable, design. . . TI admits, and the FCC laboratory confirms, that the experimental TI receiver is not in compliance with scheduled FCC rules, e.g., UHF noise figures." Zenith went on to criticize other technical aspects of the set, for which TI received the FCC contract in 1976. The Commission has recently granted R.F. Monolithics of Dallas a \$350,000 contract to develop another such receiver, showing its continued interest in the project.

The NAB surprised many by also objecting to TI's design. FCC adoption of the receiver would make existing sets obsolete and raise prices for new sets, NAB claimed. NAB was reportedly also concerned with increased government interference in broadcasting that might occur with the acceptance of the new design.

NRBA Meet To Focus On Radio's Changing Needs

The changing needs, concerns, and goals of radio stations entering the 1980s will be the theme of the Sixth Annual Conference and Exposition of the NRBA, taking place October 7 through 10 at the Washington Hilton. Anticipating record attendance, the as-

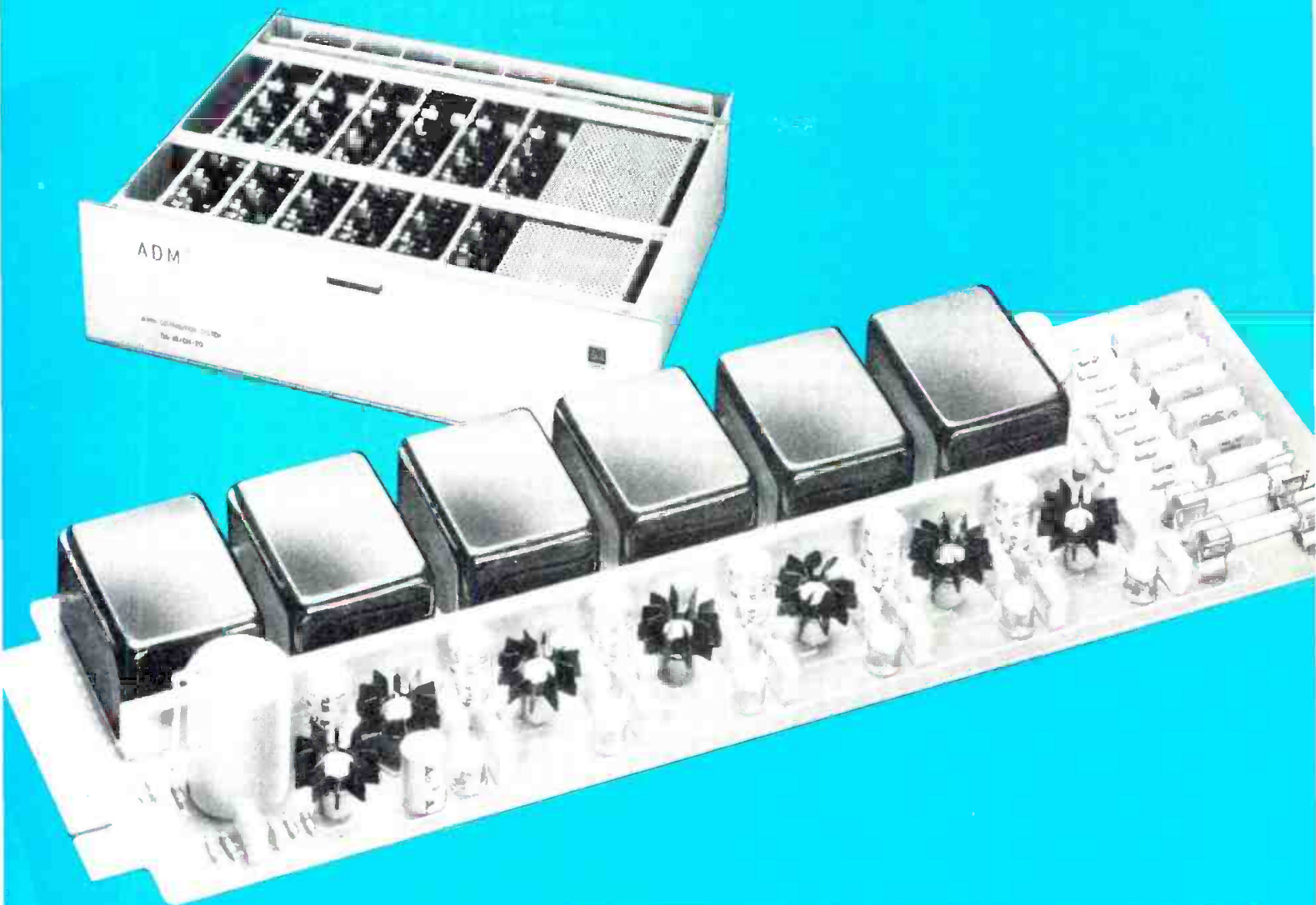

COMPANY: ADM,[®] THE AUDIO COMPANY
 PRODUCT: DA16B/CH20B AUDIO
 DISTRIBUTION SYSTEM
 RATING: UNEQUALED!

It's unique. It's ADM quality throughout. It's high on our "best seller" list because it solves the troublesome problem of reliable audio distribution for broadcasters. Here are a few outstanding features:

- Each DA16B is a one-input, six-output plug-in card.
- The input and each output is transformer coupled.
- Input levels up to +27 dBv.
- Output levels up to +27 dBm before clipping.
- Each of the six output amplifiers has an individual, front

accessed gain adjustment, as well as a test point.

- Each CH20B will house up to six DA16B cards, and has a complete set of redundant power supplies with automatic changeover.
- The DA16B/CH20B system is designed and built to meet ADM's highest quality and performance standards, and carries a five year unconditional warranty.

Contact us today for complete details about the many features the DA16B/CH20B system offers.

AUDIO DESIGNS AND MANUFACTURING, INC.

ADM *The Audio Company*

16005 Sturgeon, Roseville, Michigan 48066 • Phone (313) 778-8400 • TLX-23-1114

News

sociation has reserved a larger-than-ever exhibition hall. Approximately 80 companies will exhibit their wares in 190 booths and 90 suites devoted to the latest in equipment and services for radio.

Attendance at the yearly NRBA meet has snowballed, doubling in the last two or three years, and is expected to top 4000 this year. Radio broadcasters will find workshops on management, promotion, engineering, sales, and

programming issues, with a total of 30 topics to choose from. Programming workshops will each focus on a different format, highlighting Country, AOR, Adult Contemporary, Disco, and Top 40, with a special session on "Radio Programming for the '80s." Engineering topics include "New Audio Concepts," "Special Problems in FM," "Challenges and Opportunities of the 80s . . ." The NITA Proposals, "The 9 kHz Debate," and "Antennas, Bandwidth, and AM Stereo."

Management sessions will cover such

issues as maximizing cash flow, efficient organization of executive time, EEO compliance, evaluation of station worth, and a "Small Market Idea Exchange." Among the workshops for salespeople will be one on "The Vital Role of Women in Sales," as well as "21 Proven Money-Making Ideas" and "True Confessions of a Radio Sales Streetfighter." Promotion sessions will cover major markets, small markets, logo promotions, and "Promotion Mileage Through Public Service."

Other special panels include one on radio deregulation, in question now that H.R. 3333 has been scuttled (see separate news story), and an "FCC Forum."

A special luncheon on Monday, October 8, will feature CBS News consultant Eric Severeid as guest speaker. Severeid is the recipient of NRBA's Golden Radio Award. The Armstrong Awards will be presented at the luncheon, which will be followed by a membership meeting, tours of Washington area radio stations, and the NRBA state directors' meeting. The NRBA Promotion Awards will be presented at Tuesday's luncheon; the guest speaker for that day has not been announced. A cocktail reception will greet attendees opening night. President Carter has been invited to address the opening session on Sunday afternoon, October 7, but his acceptance had not been confirmed as of press time.

The exhibit hall will open each day of the conference at 10:00 a.m., and the schedule looks tight enough that broadcasters wishing to see the exhibits and attend all the sessions will find themselves extremely busy.

Judging by the rapid growth of its annual get-together, the NRBA seems to be growing steadily. It will have to do so without president Jim Gabbert, however. Word is that NRBA's sixth will be Gabbert's last, as he plans to step down from his post in the not-too-distant future.

Group W And WU Sign Satellite, Programming Agreement

Western Union and Group W have agreed in principle to establish a long-term satellite service arrangement that would also give WU access to Group W's Pittsburgh programming facilities.

The Westar satellite system will be used to distribute all Group W-originated video programming among its O&O stations in Baltimore, Boston, Philadelphia, Pittsburgh, and San Francisco, and between its Los Angeles production facilities and Washington, D.C., news bureau. Group W plans to build earth stations in Baltimore, Charlotte, Philadelphia, and Pittsburgh to be



Wang Time Tunnel™ because: What they don't hear can't hurt you!

All it takes is one inadvertent obscenity or ethnic slur and away goes a chunk of the market you are trying so hard to nail down.

Time Tunnel™ solves the problem for 26 cents an hour with a six second digital delay that lets you drop, chop or bleep anything you don't like, long before it hits the air.

Call the gang at Wang at 800-258-1034

for information on our free trial offer.

It could be the last time you ever have to worry about your station airing the wrong words at the wrong time.

WANG

Wang Voice Communications, Inc., Hudson, NH 03051

Circle 104 on Reader Service Card

HITACHI SK-96

Inside this superlative broadcast studio camera lives an equally superb hand-held module for field production. Here at last is a convertible that makes no compromises in picture quality...with S/N ratio of better than 51 dB...three 2/3" Saticons...500-line resolution...built-in ABO...internal triax adapter...AC/DC operation...and more. All wrapped in a super tough but lightweight diecast housing. For an unprecedented low price. Call your Hitachi dealer for more details.

**Hitachi...
Tomorrow's
technology
today.**

7 Regional Centers for 24-Hour
Parts and Field Service

- New York (516) 921-7200
- Chicago (312) 344-4020
- Los Angeles (213) 328-2110
- Atlanta (404) 451-9453
- Dallas (214) 233-7623
- Denver (303) 344-3156
- Seattle (206) 575-1680



HITACHI
Hitachi Denshi America, Ltd.
175 Crossways Park West
Woodbury, New York 11797

The Hitachi Hard-to-Top Convertible.



Camera Control Unit

Circle 105 on Reader Service Card

News

shared with WU. Existing WU facilities will serve the remaining sites. Group W's programming is currently distributed by terrestrial facilities and videotape.

The agreement is seen as affirming Western Union's intent to serve broadcasters primarily, in contrast with RCA, which deals primarily with cable.

Western Union will be able to use Group W's Pittsburgh studio and

playback facilities under the agreement. This is expected to allow WU to compete with RCA since WU will be able to insert materials into the programming it currently transmits for the bird's commercial TV users.

Meanwhile, the FCC authorized the launch of Western Union's Westar III satellite into a temporary orbital position, provided the launch takes place by September 30. The orbital position, however, will be subject to change by the FCC and WU may not provide commercial service over the bird without Commission authorization.

AT&T May Provide Private Line Services By Satellite, FCC Rules

AT&T will be permitted to provide non-government private line services over domestic satellite systems as a result of a recent FCC ruling. The Commission denied a request by Western Union and the American Satellite Corp. (ASC) that the Commission's moratorium on such services by AT&T, instituted in 1972, be extended past the July 23 expiration date.

The Commission stated that termination of the moratorium would allow AT&T and GTE Satellite Corp. (GSAT), who jointly operate the COMSTAR satellite system, to totally integrate their existing long-haul domestic communications facilities. They had previously been blocked from doing so by the requirement that non-government private line traffic be transmitted via terrestrial facilities only.

The moratorium was originally instituted to prevent communications giant AT&T from deterring others from entering the domestic satellite market. ASC had contended that AT&T's power had not declined and that it should continue to be barred from the domestic satellite field. WU asked the moratorium to be kept in force until AT&T had established that its tariff rates for private line services were just and reasonable. The three major TV networks all supported the end of the moratorium.

According to the FCC, domestic satellite carriers have had a fair opportunity to establish themselves, as evidenced by the high utilization of WU's Westar and RCA's Satcom systems. The collective success of the satellite carriers in facility utilization and service development justify the termination of the moratorium, it concluded.

Rewrite II Dies In House; 1934 Act To Be Amended

Friday, July 13, was the last unlucky day in the life of H.R. 3333, the ill-fated Communications Act rewrite attempt sponsored by Rep. Lionel Van Deerlin. Faced with an almost total lack of support for the bill among the members of the House Communications Subcommittee and strong opposition from citizens' groups and some broadcasters, the bill was scrapped after a two-day unsuccessful stab at markup.

In a memo to the subcommittee members, Van Deerlin suggested dropping the total rewrite and instead concentrating on amendments to the common carrier sections of the 1934 Communications Act. Common carrier reform is "urgent and crucial," he stated, adding, "The world can rock

Harris Leads the Way In Radio. . .

At NRBA Convention See the New Harris. . .

- M-90 Console....seven main frame configurations....wide choice of plug-in modules for ON AIR or Production facility.
- 9000 Program Control Series....with "floppy disk" memory. Plain and simple programming in English....virtually eliminates paperwork.
- 9100 Facilities Control system....designed improve a station's performance, protect its investment and cut operating costs.
- FM-25K 25,000 Watt FM Transmitter....the first to utilize a single tube design.
- MSP-90 Tri Band AGC Amplifier....protects audio quality while significantly increasing loudness.

Visit the leader in Broadcast technology....
Booths 3-7

HARRIS



COMMUNICATION AND
INFORMATION PROCESSING

Circle 106 on Reader Service Card

HIGHEST QUALITY FOR THE 1980's.

Join the Neve world of excellence for highest quality audio. From the 4 new small mixers in the 542 range to the most comprehensive TV production consoles, Neve offers an incomparable choice of state-of-the-art audio products. Please call or write. We're in your future!



Model 5422
Suitcase Mixer
Ni-Cad powered

Model 5442
Table Top
Mixer



Other 542 Range Mixers:
Model 5422R Rack Mounted
Model 5432 Table Drop Through

 **Neve**

Rupert Neve Incorporated - Berkshire Industrial Park, Bethel, Connecticut 06801 Tel: (203) 744-6230 Telex: 969638

Rupert Neve Incorporated - Suite 609, 6255 Sunset Blvd., Hollywood, California 90028 Tel: (213) 465-4822

Rupert Neve of Canada, Ltd. - 2721 Rena Road, Malton, Ontario L4T 3K1, Canada Tel: (416) 677-6611 Telex: 983502

Neve Electronics International, Ltd. - Cambridge House, Melbourn, Royston, Hertfordshire, SG8 6AU England Tel: (0763) 60776

Rupert Neve GmbH - 6100 Darmstadt Bismarckstrasse 114, West Germany Tel: (06151) 81764

News

along very well with broadcasting under the 1934 act."

Broadcast reform may not be dead, however. Several legislators have expressed intent to introduce broadcast amendments to the existing act. Al Swift (D-Wash.), a member of the subcommittee, said he would propose such legislation, minus controversial issues like the much-opposed spectrum fee or cable retransmission consent.

Few observers noted much regret at

the passing of H.R. 3333. The NRBA, however, sent a last-minute plea to its membership urging them to wire subcommittee members not to kill the bill. When that attempt failed, the association lost no time in proposing guidelines for the legislative deregulation of radio. The proposals, submitted to Congressmen Van Deerlin and James Broyhill, included extension of the license term to seven years; a public interest, convenience and necessity standard to be met by a certain percentage of nonentertainment programming; license revocation only for willful and

intentional reporting of false information to the FCC, willful or intentional failure to operate as set forth in the license, or violations of lottery, fraud, and/or obscenity laws; prohibition of FCC evaluation of program content or format; repeal of sponsorship identification rules; no entertainment of competing applications when a renewal application is designated for hearing; ownership to be limited to 10 AM and 10 FM stations, with no restrictions on cross-ownership; standards for petitions to deny or revoke to be set by FCC; and establishment of a fund for minority applicants.

NAB president Vincent Wasilewski issued a statement following Rewrite II's demise saying that Van Deerlin's attempt had "focused national attention on the need for regulatory relief for broadcasting and other telecommunications industries . . . This latest action, however, acknowledges that much of the original '34 law remains valid." He called for "a 'creative blending' of the old with the new," referring to a position adopted by the NAB board of directors in June, 1978.

Personal Attack Rule, Fairness Doctrine Modified

The personal attack rule no longer applies to uses of broadcast facilities by legally qualified candidates for public office as covered under Section 315 of the Communications Act, according to a recent ruling by the FCC. The action also exempted such uses from the Fairness Doctrine.

NBC had requested the ruling from the Commission a year ago. In response to the request, a rulemaking and inquiry procedure was instituted. As a result of the inquiry the FCC decided to continue its policy of regarding the Fairness Doctrine and Section 315 uses as mutually exclusive. The personal attack rule was also brought into conformity with that policy by amending the rule to exempt all Section 315 uses by candidates. In addition, the exemption was extended to attacks made by non-candidates during Section 315 uses.

Midnight Sun Signs Landmark Agreement With Citizens' Coalition

Midnight Sun Broadcasters, Inc., licensee of seven Alaska radio and television stations, and Alaskans for Better Media, Inc. (ABM), a nonprofit coalition of citizens' groups based in Anchorage, have signed an agreement whereby Midnight Sun will substantially alter its policies on local programming, equal opportunity employment, and Fairness Doctrine issues. If the agreement is approved by the FCC, ABM's petition to deny, filed against Midnight Sun early last year (see

Look what's new... at UMC

UMC Beaucart CARTRIDGE TAPE EQUIPMENT



Type 10 Stereo Recorder Reproducer

Compact, low profile recorders and reproducers—featuring our cool running Beau direct drive patented pancake motor and state-of-the-art electronics. Mono or stereo, single cue or three cue, with fast forward available.

- Beaucart II

Beaucart quality in an economical package—mono, single cue—recorder or reproducer



Beaucart Monitor II

Our popular Beaucart II reproducer with a built-in amplifier and speaker—perfect for NEWSROOM, CONTINUITY, SALES OR PROGRAMMING OFFICE.



Beaucart II Recorder Reproducer

Beaucart II Reproducer

STEREO CONSOLES

- Beau-Master™—Up to 16 stereo mixers, 48 switchable inputs, with 1 mono and 3 stereo output busses—the perfect AM-FM or AM stereo console.

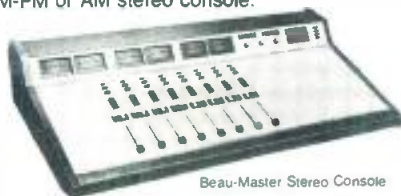

Beau-Master Stereo Console



- Beau-Pro™—Up to 8 stereo mixers, 24 switchable inputs, 2 metered stereo busses—the perfect production companion for the Beau-Master.

CARTRIDGE TAPE ACCESSORIES

- Splice Finders/Erasers
- Beau Replacement Tape Heads (for all popular cartridge machines)
- Beau Replacement Motors
- Beaucart Alignment Tools

Call us—toll free for information—800 243-6178*

*Except Connecticut, Alaska and Hawaii

Visit Booth 207—NRBA

UMC Broadcast Products Division
UMC ELECTRONICS CO.
480 Sycamore Road, Wallingford, CT 06491
203 268-7300 • connect

UMC

Circle 108 on Reader Service Card

WALL STREET TODAY
 DOW JONES: 757.54
 ↓ 5.80
 VOLUME: 21,950,000
 NYSE: ↓ .00
 AMEX: ↑ .02

News Index

- ✉ Postal Strike
- ⚡ Storm Watch
- 🎵 Maestro Returns
- 🎬 Movie Review
- 🏆 America's Cup

GAS RATIONING

80% REPORTING

NO 53,942 58%
 YES 38,617 42%

1717

THE MORNING SHOW

TIME: 8.25

TEMP: 68°



COMMENTARY NEXT

FOR HOME DELIVERY

Daily Sentinel

Daily Sentinel

Daily Sentinel

CALL: 326-5740

EASY WRITER.

VIDIFONT® started it all. The first name in character/graphics generation. And today, VIDIFONT is the most flexible, easiest-to-use system.

VIDIFONT gives variety and visual impact—with features like an unsurpassed number of custom fonts and special logos. Patented character overlap. Flash, character colors, black or outline. Varying edge sizes, levels and edge positions, including dropshadow. Background colors on full-row, partial-row or page basis. Plus, color windows for graphic highlighting, and much more.

And now, you have the total capability to prepare, rehearse and deliver top quality election coverage to your viewers. The VIDIVOTE® Election Reporting Package and VIDITEXT® on/off line composing, editing and animation make VIDIFONT the industry's choice for rapid, accurate accumulation and display of data.

With options like VIDIVOTE and VIDITEXT, you have a carefully designed microprocessor-based system that is self-contained. There's no need for computer time-sharing or a staff programmer. Simple, easy keyboard functions give you an all-new capability for character/graphics generation. VIDIFONT. Try doing things the easy way with the Easy Writer. More than 400 systems in operation.

Add VIDIFONT and add impact. Contact Thomson-CSF Laboratories, Inc., 37 Brownhouse Road, Stamford, CT 06902. (203) 327-7700. TWX (710) 474-3346.



THOMSON-CSF

Circle 109 on Reader Service Card

www.americanradiohistory.com

BM/E, April, 1978, p. 6), will be withdrawn.

ABM, comprised of environmental, women's, native Alaskan and other minority, and student groups, came together in September, 1977 to examine the state's broadcast media. They complained that Midnight Sun displayed editorial bias, overcommercialization, and inadequate local programming. ABM also said that the broadcaster

charged different rates to opposing political candidates, restricted PSAs to persons who ran paid advertisements, and had a poor equal opportunity employment record. Another major beef was the lack of coverage given to environmental issues.

According to the terms of the agreement, Midnight Sun will set up Citizens' Advisory Boards in Anchorage, Fairbanks, Juneau, and Ketchikan. The boards will help with community ascertainment, recommend topics for local programming, and determine Fairness Doctrine compliance.

Midnight Sun also agreed to increase the number of PSAs and guest editorials it broadcasts according to specific guidelines and to improve its public affairs programming, with emphasis on the environment and native Alaskan, women's, and consumer issues. The broadcaster promised to raise its percentage of female and minority employees to FCC-designated minimums and improve news programming by increasing the number of news employees and purchasing more equipment.

ABM has expressed optimism about getting FCC approval for the agreement, which includes provisions for reimbursement for ABM and Media Access Project, ABM's Washington-based counsel, as well as withdrawal of ABM's petition to deny.

Comments, Information Sought On Loud Commercials

The FCC has begun an inquiry on current developments in measuring the loudness of radio and television commercials and whether Commission action is needed on the problem. Since 1965, Commission policy has held that "objectionably loud" commercials are contrary to the public interest and should be avoided. At that time, however, the FCC conceded that there was no reliable method of measuring "objectionable loudness." Field tests conducted between 1965 and 1973 concluded that audio processing, while common, was used equally with programs and commercials. Attempts to develop a device for measuring loudness during that period achieved little success.

The Commission now feels that researchers have a better understanding of loudness and are capable of producing devices to measure it. To this end, it is asking for comments and information on suitable methods or devices for measuring loudness; the extent of "objectionable loudness" in commercials and its causes; listener reaction to loudness; standards for loudness; and ways of controlling it, including marketplace forces and FCC regulation.

Comments are due by December 15. The Commission noted that it preferred that the matter be settled by self-regulation, but that it would take regulatory action if necessary.

FCC Denies Exclusivity Request For Donahue Show

The FCC has denied a request for syndicated exclusivity protection sought by WOTV-TV, Grand Rapids, Mich., for its coverage of the *Phil Donahue Show* because of a rule excluding live programs from protection. WOTV, owned by Manhattan Cable Television, Inc., carries the show on tape under

3D SERIES



Proven.

Over 5,000 ITC 3D's in use—15,000 decks—Stereo and Mono.

Economical.

Three premium line reproducers cost little more than two SP Series single decks.

Compact.

Three deck convenience in the space of two SP single decks.

Recorder.

Add a WRA Recording Amplifier and the bottom deck becomes a Master Recorder/Reproducer.

Broadcasters' No. 1 Choice

To place a no-risk order (30 day guarantee of satisfaction)

Call Toll-Free: 800-447-0414.

In Alaska, Hawaii or Illinois Call Collect: 309-828-1381

INTERNATIONAL TAPETRONICS CORPORATION

2425 South Main Street, Bloomington, Illinois 61701

Marketed exclusively in Canada by McCurdy Radio Industries, Ltd. Toronto

From paint-by-the-numbers to creating a masterpiece.



Michelangelo
The Creation of Adam
Sistine Chapel

We have become a generation of sophisticated television viewers who demand and expect professionalism at every level. From putting together a simple, single-camera training tape to the intensity of a two-day editing session preparing a ninety minute special, the goal is the same — effective communication.

Only one editing system virtually guarantees the maximum effect of your creativity—the CMX 340X.

We have spent many years of design effort to bring you a system that will support you today, and continue to be your most useful production tool as your demands grow. So that the editor can get the most out of the system, we offer formal training seminars at all levels with the assistance of some of

the top editing talent in the broadcast industry.

The CMX 340X is, indeed, a sophisticated system using state-of-the-art distributive processing techniques and advanced software. It is this unique application of computer technology that gives the editor the greatest speed, simplicity of operation and a complete range of editing options. The CMX 340X is fully expandable, so that you can buy only what you need when you need it, with the assurance that your system can be upgraded as your requirements become more diverse.

Surprisingly, the best is not expensive. The financial concerns of a major network are no different from those of a commercial organization setting up a

production facility — maximum capability for minimum investment.

You can look at and evaluate and test other editing systems. However, when you're done and want the greatest capabilities and the best value now and in the future, you'll buy the CMX 340X.

The system that will be your most useful production tool as you grow from beginning art student to Michelangelo.

State of the Art.

See us at SMPTE, Los Angeles, Booths 511/512.



Orrox Corporation, 3303 Scott Blvd., Santa Clara, CA 95050 (408)988-2000 Telex 910-338-0554

International Representatives: Magna Techtronics Pty. Limited, Artarmon, N.S.W., Australia / Totsu, Tokyo, Japan / Telemation de Mexico, Mexico City / Marconi Communications Systems, Ltd., Chelmsford, England / Thomson-CSF, Gennevilliers, France / GTC GmbH, 2070 Grosshansdorf, W. Germany

Circle 111 on Reader Service Card

News

contract with Multimedia Program Productions, Inc., which joined in the petition. Two local cable companies, General Electric Cablevision Corp. (GEC) and Muskegon Cable TV, carry the program live in the same market by picking it up on satellite from WGN in Chicago, where it originates. The WOTV version is aired later.

WOTV asked GEC and Muskegon to give it exclusivity protection a year ago. Both refused the request because

at that time WOTV was showing an edited half-hour version of the hour-long show. When WOTV amended its contract with Multimedia to carry the full hour, it again asked for exclusivity and was again refused. It then turned to the FCC, which denied on the grounds that the syndicated exclusivity rules specifically exempt live programming. The Commission also noted that WOTV had not presented evidence that it would be harmed financially in any significant way if a waiver were not granted.

The decision sparked controversy

among Commission members, and several issued separate statements criticizing it. Abbott Washburn, joined by Robert E. Lee, noted that similar situations "could well happen in scores of markets as WGN develops into a superstation." He claimed that the decision could force Multimedia to discontinue the call-in portion of the show and its live broadcast on WGN. "Clearly," he stated, "this is the exact opposite of encouraging diversity of programming."

Commissioner Quello, while "reluctantly" concurring with the decision, expressed concern that the FCC's "permissive attitude toward the superstation concept" could result in "gross basic inequities in disregarding program property rights and the further threat to an orderly system of TV allocation."

Commissioner Brown, also concurring, was "troubled . . . that there is no explicit policy justification for excluding live syndicated programs" from protection. As did Washburn, Brown noted that when the rule was adopted, in 1972, it was not technologically possible to economically transmit live programming on a national basis.

United Video Will Pay Cable Systems To Use New Service

United Video has announced plans to pay cable systems one cent per subscriber per month to carry the New York-based Music Preview Network, an advertiser-supported service to begin this fall. Record companies and promotional agencies will pay MPN to play their new releases; each hour will be 95 percent music. Live announcers will be featured and transmission will be full-frequency mono.

The signal will be uplinked to Satcom I and will be available as an audio subcarrier to cable systems with earth stations. United Video will be responsible for marketing the service and assisting cable systems in obtaining the proper equipment.

United Video's president, Roy L. Bliss, is claiming that "growth will be phenomenal" for MPN. "This service reinforces our belief in the boundless entertainment capabilities of cable," he said.

K.C.'s UHF Indie Scores Rare Prime Time Coup

KBMA-TV, the Scripps-Howard UHF indie in Kansas City, pulled off a rare coup in the Nielsen May sweeps when it beat out the NBC-TV affiliate in its market, WDAF-TV, in metro share with a 22-21 edge in the highly important prime-time period, 7-10:00 p.m. Mon.-Fri.



(What happens next is the difference between Fidelpac Blank-IT and your current bulk eraser)

Break the law of gravity with your current bulk eraser and go pick up another one. Do the same with Blank-IT, and just go pick it up. Blank-IT goes right on bulking.

Fidelpac houses Blank-IT in a lightweight, balanced case that's virtually indestructible. Installs a high mu core with a longer ON duty cycle and more magnetic strength than any hand-held

eraser. Builds thermocouple protection into that core for burn-out proof operation. Tops it with a balanced, contoured handle that stays where we put it. And unconditionally guarantees Blank-IT against electrical burnout and mechanical breakage for a full year after purchase.

\$59⁹⁵ Manufacturer's Suggested Retail Price

Blank-IT. By Fidelpac. The first hand-held bulk eraser guaranteed to stand up. After the fall.

ELECTRONICS by FIDELIPAC



109 Gaither Drive • Mt. Laurel, NJ 08057 U.S.A. (609) 235-3511

See us at NRBA Booth #11

® Trademark

Circle 112 on Reader Service Card

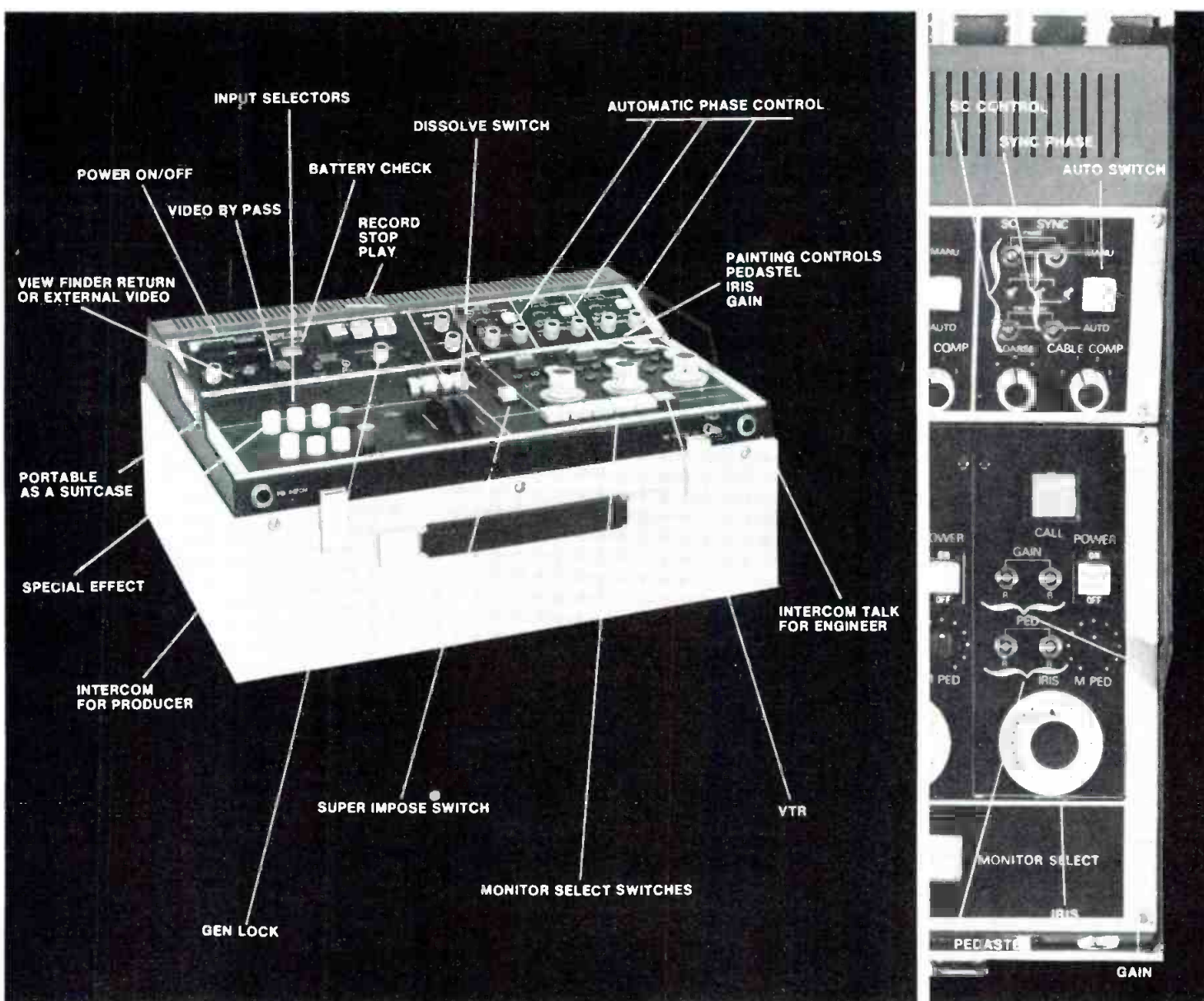

Portable Production System Works on Battery or 120-Volt AC Line!

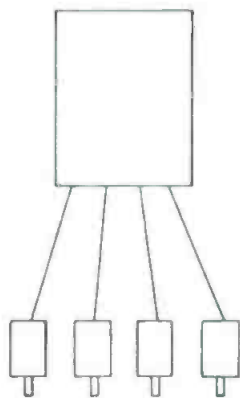

Automatic Phase Control. No need to adjust controls on individual sync phase and sub-carrier phase for each camera. Simply plug four cameras into the switcher and the automatic phase control does the adjustments for you.

Compatible with any camera. Customizes to your equipment. Connects to VTR. The Asaca ASW-100 portable switcher is designed for ENG and EFP cameras, including Asaca-2000. Small and light with features ideal for field production.

Operates on battery pack, 12-volt vehicle battery, or 120-volt AC line. With the latter two, the switcher can accommodate multiple cameras with VTR. Full operations remote controls optional. Designed for use with Asaca-2000 camera. Non-Asaca cameras containing internal gen lock circuitry use black burst output, providing for each camera position. Painting control permits control of color, iris and pedastel of TK 76, HL 77 and Asaca-2000.

The ASW-100 includes a "sync" generator. Internal gen lock circuit permits VTR signals as a fourth input for editing or program modifications. Switcher is vertical

interval and processes composite video signal. Mixer-fader is included, capable of special effects.

Optional monitoring with AMB-100 monitor. Provides three or four B & W source monitors and wave form monitor for use with external color line monitor.

Here's a full production system capable of expanding your mobile operation while maintaining full broadcast quality.

Contact us for a free demonstration.

ASACA®

ASACA CORPORATION OF AMERICA
1289 Rand Road, Des Plaines, Ill. 60016
Phone (312) 298-4380

News

Although both stations were tied at 11 rating points in the metro ratings, KBMA nosed out the NBC affiliate in what has to be one of the most stunning rating developments in the independent ranks for an entire sweep rating period in a major market. In the Nielsen DMA only one percentage point separated the independent from the NBC affiliate, with WDAF garnering an 11 rating and 20 share that KBMA-TV nearly matched with 10 rating, 19 share.

"We did it with a mix of sports, movies, and special programming such as the OPT offering," said Bob Wormington, KBMA president and general manager.

Wormington, who is also chairman of the INTV, noted that the ousting of a network affiliate in a major market in a prime-time sweep period was milestone for an independent station. He expects the gap between network affiliates and independents to continue to shrink in other markets as more and more programming becomes available to independent TV stations.

The rare accomplishment of ousting the NBC affiliate from third place in the Kansas City market in Metro share in a sweep period also established KBMA-TV as one of the top-rated independent TV stations in the country. "We've checked 15 of the top markets," said Wormington, "including Chicago, Houston, Dallas, and others, and our sweep ratings and share, like Abou Ben Adhem, lead all the rest."

News Briefs

The NAB has repeated its request that the FCC establish a joint Government-Industry Advisory Committee on full-time radio service. The proposed committee would prepare in-depth studies of the various methods of accomplishing full-time service for all radio stations without diminishing service for other classes of stations The Supreme Court's decision permitting newspapers to print the names of juveniles accused of crimes was praised by NAB senior VP and general counsel Erwin G. Krasnow Portions of U.S. Supreme Court proceedings were broadcast for the first time ever by CBS Radio in late June. Tapes of sessions in the Pentagon Papers case were aired during a special news program about the case.

A federal appeals court has upheld the FCC's denial of a Fairness Doctrine complaint against CBS, Inc., and its O&O stations. The complaint, filed more than two years ago by the American Security Council Education Foundation, accused CBS of violating the doctrine in its coverage of national security issues The FCC has revised and clarified its rules requiring commercial broadcast stations to announce their obligation to serve the public interest. The new version of Section 73.1202 does not change previous requirements, but rather states them in a more understandable manner.

The Associated Press Radio Network now has affiliates in all of the 50 states. Its latest affiliate is KKUA, Honolulu Arnold S. Lerner, chairman of WLLH, Inc., Lowell, Mass., has been elected to a one-year term as chairman of the NAB Radio Board of Directors. Edward O. Fritts, president of Fritts Broadcasting of Indianola, Miss., will serve as vice-chairman Donald F. Breidt has been named executive director of SMPTE. Breidt succeeds Denis A. Courtney, who retired June 30 after 26 years with the society The FCC has announced several new appointments. Roy J. Stewart takes over the Renewal and Transfer Division; Henry L. Baumann will head the Policy and Rules Division; and Frank G. Washington is deputy chief of the



MICROCOMPUTER BASED — SELF-CONTAINED COMPLETE CREATIVE FLEXIBILITY

STANDARD FEATURES

Model Q-V

12 character sizes by row . . . broadcast quality character resolution . . . 192 row resident memory . . . absolute centering . . . roll . . . crawl . . . built-in maintenance diagnostic program . . . and more!

Model Q-VI — all of the above plus

24 character sizes by row . . . background colors by row . . . variable page sizing . . . positionable titles . . . roll to static display . . . insert/delete and open/close editing . . . memory protect NiCad batteries . . . and more!

Model Q-VII — all of the above plus

Multiple resident upper and lower case fonts selectable by character . . . NANOLOG™ character refinement . . . 4 quadrant shadow or full border edging by row . . . adjustable auto page fade . . . and more!

WITH OPTIONAL . . .

Mini-disc and digital cassette extended memories.

**SYSTEM
CONCEPTS**
To Be Letter Perfect

395 Ironwood Drive
Salt Lake City, Utah 84115
PHONE: (801) 486-3833
TWX: 910-925-5684

Circle 114 on Reader Service Card



datatron, inc.

Supplying a Full Spectrum of Videotape Editing Products Worldwide



Whether your videotape editing requirements call for a super-sophisticated editing system that can control eight VTRs and a switcher simultaneously (like our Datatron 2000), or a two-to-three VTR editing system that performs frame-accurate edits using either SMPTE code or control track pulses (like our Tempo 76), or editing peripherals like our SMPTE code readers, generators, jam-sync generators, character inserters and edit decision lists, you'll find what you need in Datatron's broad product line.



For detailed information on the most complete editing product line in the industry, contact:
Datatron, Inc., Editing Systems Division, P.O. Box 11427, Santa Ana, Calif. 92711 • (714) 540-9330.

Circle 115 on Reader Service Card

News Briefs

Broadcast Bureau **Microwave Associates** announced the appointment of Erik van der Kaay to the post of vice president and general manager of its broadcast division

The NAB's **Radio Programming Conference '79** will take place September 9 through 12 at the St. Louis Stouffer's Riverfront Towers. Scheduled events include question-and-answer sessions on specific formats and a workshop on program syndication

. . . . The **RTNDA** will meet for its **annual conference** November 6 through 8 in Las Vegas. Theme of this year's gathering is news broadcasting in the years ahead; speakers include CBS News president Bill Leonard and CBS newsman/humorist Charles Osgood, as well as Walter Cronkite, Richard Salant, and Howard K. Smith **Over 300 booths** have been taken so far for SMPTE's 121st exhibit, to be held at the Century Plaza Hotel in Los Angeles October 21 to 26. The concurrent conference will feature sessions on contemporary TV and motion picture technology.

The fourth annual **Conference on Satellite Communications for Public Services**, sponsored by the Public Service Satellite Consortium, will take place at the Washington Hilton, Washington, D.C., October 10 to 12. For information, write to Director of Communications, Public Service Satellite Consortium, Suite 907, 1660 L St. NW, Washington, D.C. 20036 The New York Chapter of the Society of Broadcast Engineers will hold its **sixth annual regional broadcast conference** on November 18 and 19. Those interested in presenting papers should send the title and abstract or summary to SBE c/o Mr. Dan Dorozinsky, P.O. Box 234, Bronx, N.Y. 10463.

The **Western Society for Telecommunications and the Northwest Video Resources Association** will meet jointly at the Portland Hilton, Portland, Ore., October 3 through 5. The agenda includes sessions for TV, radio, video, and film producers and for educational and public broadcasters. Write to Elizabeth Patapoff, WESTVIDRA Conference, 2828 S.W. Front Ave., Portland, Ore., 97201 The International Tape Association, Inc., will host a seminar on "**Home Video Programming — 1979**" at the New York Sheraton Hotel October 23 to 25. For program information contact ITA at 10 W. 66 St., New York, N.Y. 10023, (212) 787-0910.

Bell & Howell's **TeleMation** Division has announced the acquisition of the assets and business of **Mach One Digital Systems, Inc.**, manufacturer of the Mach One videotape editing system. The editor will be sold and serviced through TeleMation, which will start to manufacture it in late 1979 **Ampro Broadcasting** has purchased **Scully Recording Instruments** and has changed its name to **Ampro/Scully** to reflect the new association. Executive offices have been relocated to the company's new manufacturing facilities at 826 Newtown/Yardley Rd., Newtown, Penn. 18940, (215) 968-9000 **Philips Industries** of Holland has offered \$78 million for 39 percent of the stock of British-based **Pye**. Philips hopes to make Pye a wholly-owned subsidiary.

Ampex Corp.'s board of directors declared the company's first dividend in its 35-year history less than two weeks after reporting its highest-ever net earnings and revenues **MCI, Inc.**, of Fort Lauderdale, Fla., has entered into a licensing agreement with **EMI Ltd.** of Middlesex, U.K., to manufacture digital tape recorders **Teleprompter**, the nation's largest CATV company, has signed agreements with **United Video** of Tulsa, Okla., to provide superstation WGN's programming to 60,000 Florida cable subscribers. **BM/E**

Your money's worth...

surprising economy plus
more features.

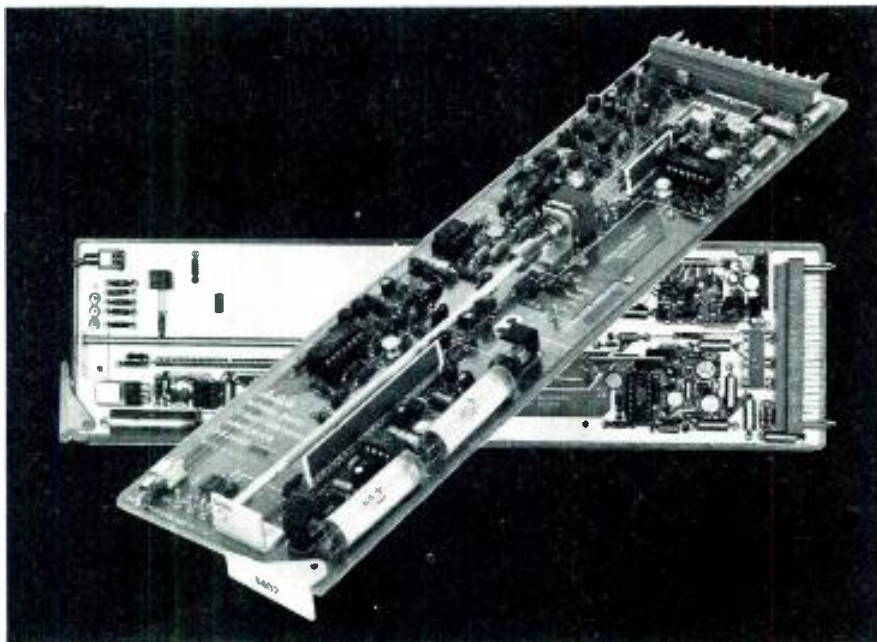

Today's GVG Model 3401 Video DA — equivalent to the Model 700 of 1966 — actually *costs 26% less* than the 700 did in 1966! And today's Model 3402 Video DA, a special-purpose precision instrument for exacting requirements, *costs exactly the same* as its predecessor Model 700!

Not all 3400 Series distribution equipment is priced the same or lower than GVG equivalents of 13 years ago. But *every* model offers more features than the 700 or 900 Series equipment of 1966.

Judge for yourself what makes GVG 3400 Series a great value; circle the number for the catalog, and address of your nearest GVG office.

(Prices: Nov '66 and May '79 lists)

THE GRASS VALLEY GROUP, INC.®

P.O. BOX 1114 GRASS VALLEY CALIFORNIA 95945 USA

Circle 116 on Reader Service Card

WORLD'S LARGEST SELLING TBC/FRAME SYNCHRONIZER.

SMALL WONDER.

ADDA's VW-1 Frame Synchronizer with infinite-window time base correction works digital wonders with television signals. Here's a frame synchronizer that prevents blanking problems, locks remote, network, EFP/ENG and satellite feeds to your station reference. Plus it offers freeze frame and freeze field capabilities.

Teamed with heterodyne color VTR's, the VW-1 time base correction goes all the way with an infinitely wide full-frame window. The VW-1 features adjustable velocity compensation and chrominance-to-luminance delay. Blanking is always within specifications. A remote control panel accessory is also available.

Viewers of the 1979 Tournament of Roses Parade and Super Bowl XIII telecasts witnessed brilliant performances by the VW-1.

Now, you too can see why our recognized low cost, compact size and unmatched combination of features have allowed us to place more units in operation than anyone else in the world. No one comes close. Small wonder.

Call or write for information or a demonstration. 1671 Dell Avenue, Campbell, California 95008 (408) 379-1500.



ADDA CORPORATION

VW-1 SYNCHRONIZER



ADDA CORPORATION

Circle 117 on Reader Service Card

The Head Comparison.

	CMC Technology		Spin Physics		Ampex		RCA		Videomax	
	Ferrite	Metal (Alfesi)	Ferrite	Metal	Ferrite	Metal (Alfesi)	Ferrite	Metal (Alfesi II)	Ferrite	Metal (Sendust)
Ampex Mark III	●	●				●				●
Ampex Mark X	●	●	●			●		●		●
Ampex Mark XI						●				
Ampex Mark XV	●	●	●			●				●
Ampex Mark XX	●	●				●				
RCA Highband	●	●	●					●		●
RCA Lowband	●	●						●		●

Because CMC Technology offers both ferrite and alfesil transducers for most major VTR's, we can give you unbiased advice on the head you should use to get the best quality at the lowest cost per operating hour.

● Product refurbishing by manufacturer

to-Head

Check and compare.

At CMC Technology, we refurbish more kinds of video head assemblies than any other company. As the comparison chart shows, we offer both ferrite and alfesil transducers for most major VTR's. This means we can give you what our competitors can't—unbiased advice on the head assembly you should be using to achieve optimum performance at the lowest cost per operating hour.

What the chart doesn't show you is just as important:

Since 1973, we've supplied a major share of video head assemblies to ABC, NBC, CBS, major U.S. production houses, the BBC, and the Australian Broadcasting Commission.

CMC Technology is the only company that converts the Ampex Mark X to a Mark XV, which is compatible with AVR-2's and AVR-3's.

Our XPL-series transducers are the only ferrite transducers that retain the original geometry of the industry standard for total compatibility.

CMC Technology has the shortest turnaround time of any company—usually five days or less.

All this adds up to one thing: Confidence. When you do business with CMC Technology, you can be sure you're dealing with an experienced, reliable company—someone you can depend on.

Make us prove it.

We're so confident of our products that we'll send you one of our heads to evaluate at no obligation. If you like it, keep it. If you don't, send it back. It's as simple as that.

For superior quality at the lowest cost per operating hour, put our heads to work for you. Call or write us today.

CMC Technology Corporation, 733 North Pastoria Avenue,
Sunnyvale, CA 94086 Phone (408) 245-3342 TELEX 910-3970012



CMC
TECHNOLOGY

Circle 118 on Reader Service Card

MODEL
850-TR



The SERIES 850 AUDIO CONSOLES are specifically designed for the broadcast and production situation. Model 850TR is ideal for television production...it offers convenience and flexibility at reasonable cost.

- 12 Channels
- 4 Buss plus master mixing
- 6 EQ Channels
- Illuminated push-button controls
- All channels switchable high level/mic
- Built-in digital timer
- 8 x 4 input selector optional

DYMA
ENGINEERING

(505) 758-8686
P.O. Box 1697
213 Pueblo del Sur
Taos, New Mexico 87571

Circle 119 on Reader Service Card

RADIO

PROGRAMMING & PRODUCTION FOR PROFIT

Serve The Weather Straight Or With The Flavor Of Your Choice

THE WEATHER FORECAST is a universal of radio programming across all formats, station sizes, markets. But that does not mean that every radio weather report has to be exactly the same dish. A radio management has a wide choice as to the style of weather forecasts and can use the weather to strengthen the station's image and identity.

Are you unhappy with what your weather reports are now doing for your programming? The following is a brief review of the main *kinds* of weather data sources, with the general character of each. You can choose from among the sources the kind that seems most likely to meet your need.

The U.S. Weather Bureau, now part of the National Oceanic and Atmospheric Administration (NOAA), is of course the basic source of weather information in this country. NOAA has a series of effective methods for distributing developed weather data to the public. Two of these interface directly with radio broadcasting (as described first in the May, 1977, issue of *BM/E*).

The NOAA teletype service is a 24-hour wire service, with a short forecast repeated every few minutes and updated every couple of hours. If a radio station subscribes, NOAA will pay the telco line charges into the telephone central office in the station's city; the station picks it up from there. Thus the only cost to the radio management is a dedicated telco line into the local central office, plus the rent or capital charge for a teletype machine.

The NOAA teletype advisories can be read on the air as received or used as

the basis for air scripts developed by station personnel. This is authoritative, brief, no-frills weather.

The other relevant NOAA data pathway is a 24-hour over-the-air radio service, coming from specially constructed NOAA FM transmitters operating on three frequencies in the 160 MHz band. There are now nearly 300 such NOAA stations; in a few months there will be about 340, covering areas that hold more than 90 percent of the U.S. population (see the map). The average coverage area of an NOAA weather transmitter is about 40 miles in radius; every medium-to-large city is within reach of one, and many smaller cities besides.

Each NOAA station puts on the air every few minutes a recorded forecast for the area served by that station. This is updated every few hours. In addition, a special warning bulletin goes out whenever there is an emergency condition in the area.

The special receivers needed to bring in the NOAA radio broadcasts are marketed by at least 35 firms, including the large electronics chains such as Lafayette, Radio Shack, and Heathkit and the major manufacturers — RCA, Zenith, General Electric, and others — plus many smaller firms. Prices range from less than \$20 for a single-channel crystal receiver to several hundred dollars for a model with 600-ohm output, high sensitivity, and switch tuning to all three frequencies: 162.40 MHz, 162.475 MHz, and 162.55 MHz. Many of the very small receivers, incidentally, are designed to be carried by

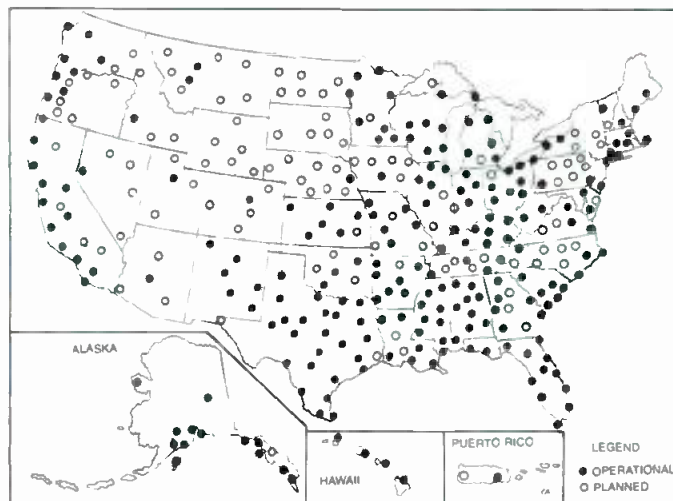

NOAA weather transmitters in operation as of July 16, 1979



Model 1701A
Designed for lowest-distortion
Measurements (.0009% or >100 dB)



Model 1710A
Designed for use
in strong RF fields



Model 1700B
Designed for general
measurement applications

When you need to know about distortion, pick from the analyzers that are easier, faster, and tell you more

The performance leader

When you talk to Sound Tech, you're talking to the firm that introduced a new era in improved distortion measurements with its 1700 Distortion Analyzer.

Now you can choose from three separate Sound Tech analyzers plus several options.

In Sound Tech Analyzers you can get conveniences that simply aren't available elsewhere—conveniences like these:

- RMS, peak, and average-responding meter circuits. Different standards require different type meter circuits

- Higher sensitivity — measure distortion as low as .0009%
- Faster and more repeatable — pushbutton frequency selection measures in 5 seconds
- Balanced and bridging VM for measuring from 30 μ V to 300 V even on floating circuits
- Very-low distortion internal test oscillator with high output level of +26 dBm—adjustable down to -90 dBm in 0.1 dB steps
- Balanced, floating, center-tapped *but transformerless* output for low distortion
- Intermodulation distortion measuring option

- 150-ohm and 600-ohm outputs
- Two-year parts and labor warranty

See about our new easy purchase plan

We also have both an easy purchase plan and a lease plan that can help when budgets are running low.

So contact Mike Hogue/Larry Maguire now. Arrange for a demo and see how useful these analyzers are — not just for measuring distortion but as high-sensitivity balanced voltmeters and as low-distortion signal sources.

Call today.

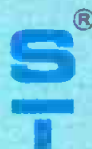

SOUND TECHNOLOGY

1400 DELL AVENUE
CAMPBELL, CALIFORNIA 95008

In Toronto: The Pringle Group

Circle 120 on Reader Service Card

www.americanradiohistory.com

We Make Fiber Optics Work

Optical Communications is not new, but broadcast quality optical communication for TV is a whole new story. And Telemet has installed more Optical Communication links for TV Broadcasters than anyone else. So get the whole story from the people who wrote the book — use the coupon below.

OK Telemet, send me the complete story on Fiber Optic Communication Links for TV Broadcasters.

NAME _____

TITLE _____

COMPANY _____

ADDRESS _____

CITY _____

STATE _____

ZIP _____

PHONE _____

Telemet

185 Dixon Avenue
Amityville, N.Y. 11701
(516) 842-2300



A Geotel Company

Circle 121 on Reader Service Card

Radio Programming

campers, hikers, or boaters.

The receivers differ in having or not having special "trigger" circuits which respond to alerting tones sent out by NOAA. There are two tones, 1650 Hz for routine updating of the weather forecast and 1050 Hz for emergencies.

The tones can be heard on any receiver and serve as aural alerts to an upcoming broadcast. A number of available receivers, however, can be put in a mute or standby condition and be turned on by the NOAA tones. A popular operation is like that of the Gorman-Redlich receiver described in the January, 1979, issue. The 1650 Hz tone throws a relay that can start a tape machine to record the broadcast. The 1050 tone, in addition, opens the audio to the loudspeaker so the warning bulletin can be heard.

tin can be heard.

Radio managements use the NOAA broadcasts in a number of different ways. The FCC has given blanket authorization to put them on the air directly. If they are taped, the recordings can be put on the air within an hour of receipt only. Further, the information in the NOAA broadcasts can be reshaped by station personnel to fit better into the management's objectives.

Another standard class of weather sources, available in every part of the country, are the wire services. AP, UPI (teletype and audio), and MBS (audio) have their own weather staffs. Many stations find this quite sufficient to their purposes and very convenient to use: staff effort is minimized.

In next month's column, *BM/E* will describe the activities of typical private weather firms that work for broadcasters. **BM/E**

BM/E's Program Marketplace

Syndicators For Radio

WCRB Productions, Inc.

750 South Street
Waltham, Mass., 02154
Tel. 617 893-7080

IF A SYNDICATED PROGRAM series of 39 two-hour programs a year has been self-supporting for more than 20 years and is still growing, we have proof that a large number of radio listeners have adopted the program on a long-term basis. The proof is especially convincing in the case of the Boston Symphony concert series put out by WCRB Productions since the series consists of original recordings made at regular concerts, a high-cost operation, with duplication onto stereo tape for distribution to subscribing stations.

The Boston Symphony series grew out of commercially successful live broadcasts of the orchestra's concerts by FM station WCRB in Boston. The management concluded in 1958 that the strong audience response to these broadcasts could be duplicated in other cities, with profit to both the syndicator and the subscribing station. Accordingly, Charles River Broadcasting, Inc., owner of WCRB, set up a new corporation, WCRB Productions, to carry out the syndication program.

WCRB Productions had to work out problems in several areas: contractual and financial relations with the Boston Symphony management; a live concert recording technique of rock-sure quality; and promoting the program to likely users. Two decades of success on both the financial and the technical fronts

show how well all these problems were solved.

The series has going for it, of course, the world-wide fame of the Boston Orchestra and of the acoustics in its home, Boston Symphony Hall. The hall is known far and wide as one of the best places in the world to listen to orchestral music.

WCRB Production's recording team has made a name for itself, too. Team leaders Richard Kaye and Louise de la Fuente have a reputation for effectiveness in their handling of microphones, tape recorders, and other equipment to capture symphony concerts with maximum fidelity.

The subscribing station pays for the Boston series with a fee based on market size. Each program has room for four local commercials. Some 80 stations are now regular subscribers; both commercial and noncommercial stations are included.

WCRB Productions has another large-scale success, this one drawn from the regular concerts of the New York Philharmonic Orchestra. Again, there is a series of 39 programs a year, each two hours long. The series is sponsored by the Exxon Corporation and is free to the subscribing station. There are three local availabilities in each program. More than 200 stations are using the New York series.

In the Boston and New York series there are expert commentators who can be introduced by the local announcer and who introduce the music, conduct intermission interviews, and give biographical sketches of composers.

WCRB Productions has also for a

EIMAC's new 8990 tetrode premieres in Harris' FM-25k.

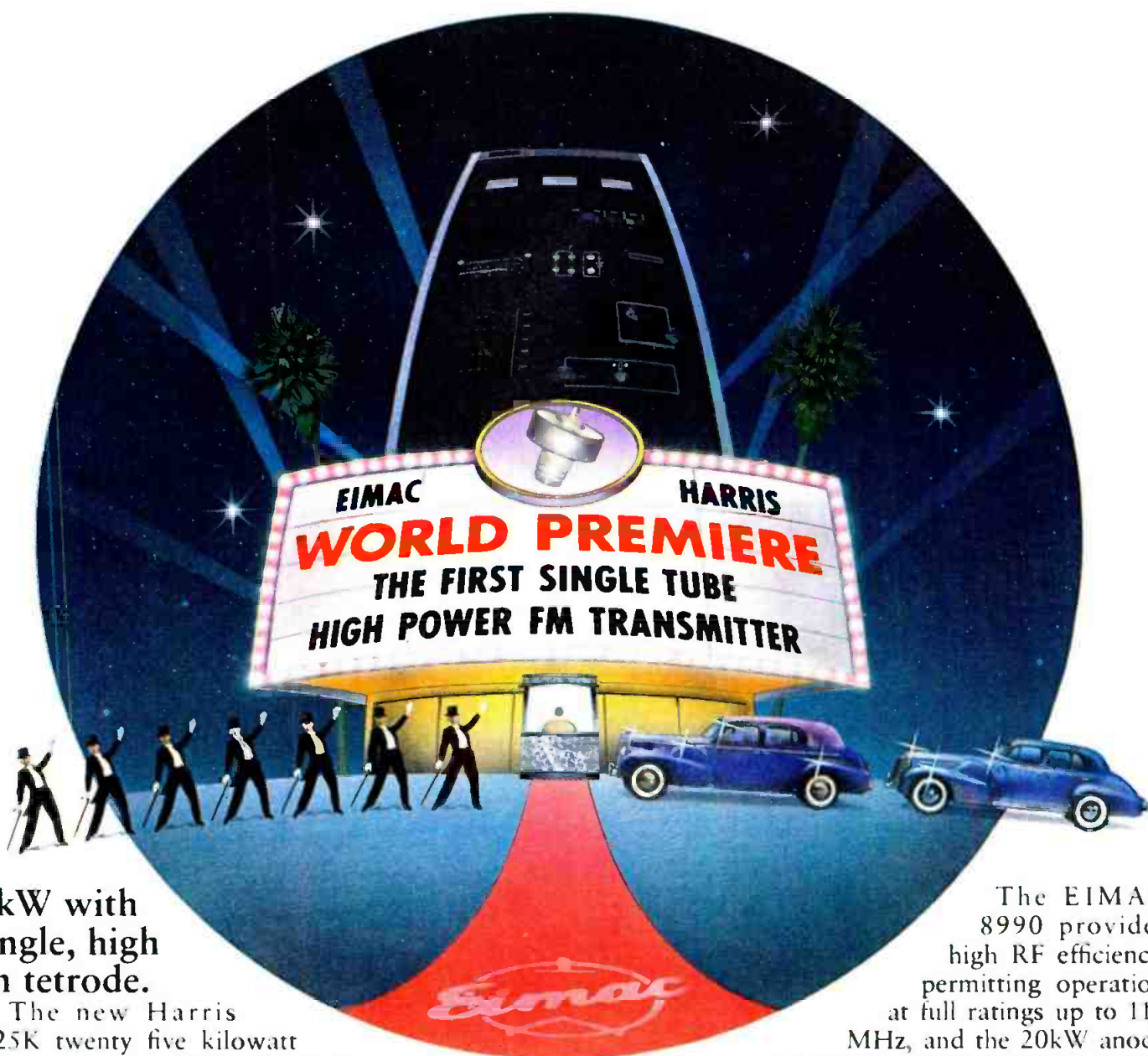

25 kW with a single, high gain tetrode.

The new Harris FM-25K twenty five kilowatt FM transmitter combines advanced solid state circuitry with the high-gain EIMAC 8990 power tetrode to present the world's first one tube, high power FM transmitter.

The FM-25K is the first transmitter to utilize the high gain, high efficiency 8990 tetrode as the final amplifier. It is driven by solid state amplifier modules to provide greatly improved transmitter reliability and a reduction in overall tuning requirements.

The ripple-fin anode of the 8990 provides exceptional cooling at reduced air requirements for quiet operation and the PA cavity design eliminates troublesome sliding contacts and assures wide RF bandwidth.

The EIMAC 8990 provides high RF efficiency, permitting operation at full ratings up to 110 MHz, and the 20kW anode dissipation rating provides ample safety for continuous heavy duty service.

Send for details.

Complete specifications on the exciting new FM-25K transmitter are available from Harris Corporation, Box 4290, Quincy, IL 62301. And complete data on the 8990 power tetrode is available from EIMAC, Division of Varian, 301 Industrial Way, San Carlos, CA 94070. Telephone (415) 592-1221. Or contact any of the more than 30 Varian Electron Device Group sales offices throughout the world.



CUERAC SERIES 1A

FUTURE JOCK

CUERAC is the world's first complete random access cartridge automation system.

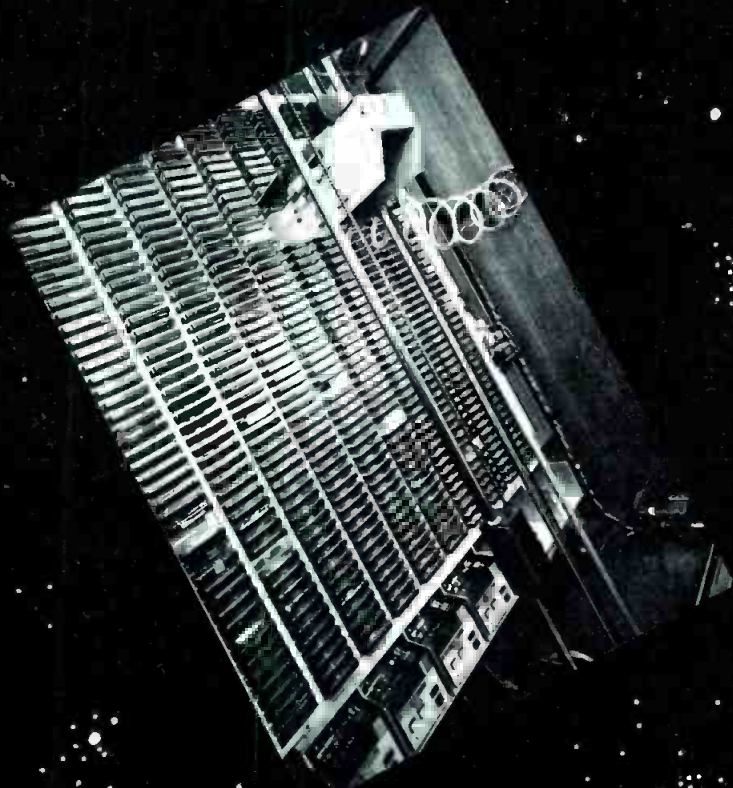

- Fully automatic computer controlled random access library of 500 cartridges.
- Computer expandable to control up to five (5) CUERAC libraries giving random access to a total of 2500 cartridges or 1-4 CUERACS and up to 40 single source replay units.
- Continuous visual display of program: current status, next 10 selected events, lapsed time, actual time, system alarm, syntax error.
- Simple programming for last minute scheduling.
- Provides FCC and diagnostic hard copy logging.



CONSOLIDATED ELECTRONIC INDUSTRIES INCORPORATED
Waterview Building, Suite 906
1925 North Lynn Street
Arlington, VA 22209
703-524-9811

Circle 123 on Reader Service Card

Program Marketplace

long period produced a yearly series of Boston Pops concert programs, again two hours long each. These non-sponsored programs cost the subscribing station a fee, based on market size; each program has room for 10 local availabilities. The venerable Arthur Fiedler was, of course, the conductor for the whole life of this series until his death in July; his successor (not announced at the time this was written) will be picked up in the next series.

In a period of expansion, WCRB Productions is now applying its expertise to additional series, a most logical extension. One new series is drawn from the regular concerts of the Israel Philharmonic: the WCRB team travels to Israel to record these two-hour programs. Another is *Music From Marlboro*, a series of 90-minute chamber music recitals recorded during the regular summer series given in the Vermont town under the direction of Rudolph Serkin, with a covey of world-famed performers to fill various chairs in the different groupings.

The latest item in this expansion operation is a series with the first installment available this past July; jazz concerts, each one hour long, produced by Willis Conover. He has been known all over the world for many years as the maestro of jazz on the Voice of America. He interviews jazz performers, presents their music, and comments on it in a style that has made him welcome wherever jazz is admired.

WCRB Productions is thinking about other additions to its repertoire, assistant manager John Emery told *BM/E*. He also said that the outfit is keeping a sharp eye on the satellite explosion. Sometime in the future the birds are sure to lift the quality, speed, and economy of WCRB's program distribution, (along with those of all organizations sending out programs over wide areas). Needed are the spread of earth terminals to many radio stations (now underway) and the development of organizations for handling satellite application to this use conveniently and economically.

The technical quality of WCRB's programs is sure to be affected strongly in the future by digital recording, too. Emery told *BM/E* that WCRB has already used digital machines on an experimental basis, with highly favorable results. When digital equipment can be had freely at reasonable prices, WCRB, and all the hundreds of other organizations making recordings of live music, will surely go digital. The combination of digital origination and satellite distribution promises a revolution in the quality of the syndicated programs bought by radio stations. **BM/E**

1964 WIRELESS MICROPHONE
1968 HANDHELD WIRELESS MIC
1969 TRANSISTORIZED SYSTEM
1971 CRYSTAL CONTROLLED RECEIVER
1972 PORTABLE RECEIVER
1974 HELICAL FRONT END RECEIVER
1976 DIVERSITY SYSTEM
1978 PORTABLE DIVERSITY RECEIVER

1979

DYNEX

In 1964 Vega developed the first wireless microphone system that offered full-fidelity sound, the first real innovation in microphones in over 50 years. Now we are proud to introduce our latest innovation . . . Dynex!

Dynex adds dynamic input range expansion to wireless microphone operation thereby eliminating the need for continuous mic gain adjustments. Set it and forget it . . . it's that simple. Two years of extensive field use with the Dynex option enables us to guarantee the same proven reliability, quality and performance that you have come to



Model 77 Transmitter

expect from Vega.

We have continually improved our systems during the past 15 years, so you can be assured that

today's Vega systems are designed with the latest in high-technology electronics and sophisticated audio engineering. Besides offering you the finest systems available, Vega is constantly working with the industry to further the art of audio processing. One example is Vega's F.C.C. petition which resulted in obtaining clear wireless channels for broadcasters and filmmakers last year.

Vega offers a variety of systems that give you a new order of freedom and that foster new confidence in your performance. When new techniques are developed . . . they're from Vega.

 **Cetec Vega**

Division of Cetec Corporation

P.O. Box 5348 • El Monte, CA 91731 • (213) 442-0782 • TWX: 910-587-3539

Circle 124 on Reader Service Card

Why you should continue Plumbicon® TV tubes in

The future for ENG grows brighter and more exciting with each passing day. The same can be said about the $\frac{2}{3}$ -inch Plumbicon, the TV camera tube that made Electronic News Gathering possible and practical at the same time.

Reflecting our continuing commitment to provide the broadcast community with state-of-the-art Plumbicon tubes—(it was a Plumbicon tube that revolutionized color TV broadcasting in 1964)—we invested almost four million dollars in the development of the $\frac{2}{3}$ -inch Plumbicon tube, most of it before the first ENG cameras were even introduced. Very early in the game, we felt that electronic journalism, with the support of modern tube and camera technology could surely add a new dimension to television broadcasting.

Even with that confidence, the phenomenal acceptance of Plumbicon-equipped portable cameras nearly overwhelmed us, as it did everyone else. In just 18 months we have supplied almost 4000 of these tubes to U.S. broadcasters!

In a market of such magnitude, it was not unexpected that other $\frac{2}{3}$ -inch camera tubes would arrive on the scene, sooner or later, with the usual "ours is better than theirs" claims. We feel that much conflicting and contradictory information has been given to the broadcast industry, regarding these new tubes. In the final analysis, only you, the broadcaster, can judge the *system performance* of these tubes and compare their performance *in the camera* with the Plumbicon tube.

In the meantime, we offer some of our own experience on the system performance of the Plumbicon tube compared to the Saticon (Registered trademark NHK/Japanese Broadcasting Corporation), one of these recently arrived new products.



Sensitivity Sensitivity is the critical parameter in ENG. In the field, where you have no control over lighting you need the Plumbicon tube's greater sensitivity to maintain an acceptable signal-to-noise ratio in your final edited news story. Even in those next-to-impossible lighting situations, you are more assured of producing a useable picture with a Plumbicon-equipped ENG camera than with the same camera equipped with the Saticon.

Resolution Your final, edited tape is the criterion by which you must evaluate ENG system performance, and your pick-up tube should always be selected with that fact in mind.

Resolution specifications are a good example of this principle. Plumbicon tube sensitivity gives you enough latitude for aperture correction with very little loss in S/N ratio, to achieve the required 100% modulation depth at 5 MHz, but the resolution of most ENG systems is limited by the video tape equipment used. From the systems performance point of view, therefore, a pick-up tube chosen solely for its resolution specifications may have no positive effect at all on picture quality!

Lag The Plumbicon tube has lag characteristics that are so favorable that it can be used entirely without bias light. If your camera provides bias light, it simply improves the Plumbicon's lag characteristics. The Saticon *must* use bias light or its pictures will be seriously degraded. In the middle of a news event, should a bias light lamp burn out!

to specify $\frac{2}{3}$ -inch your ENG cameras.

Temperature Stability

Since the Plumbicon's photoconductive layer is processed at temperatures in excess of 175°F, your Plumbicon tube can tolerate temperature excursions that may take the photoconductor to 160°F. The Plumbicon tube tolerates 160°F ambient without damage of any kind. The Saticon, however, will experience partial or complete layer destruction at these temperature levels after a few hours. It is totally conceivable that your ENG camera will experience temperatures which will cause the Saticon tube in your camera to approach a critical life condition.

Life Based upon actual operating experience with the Plumbicon, rather than on statistics of accelerated life testing, you can expect from 2 to 5 years of service, depending upon operating practice.

Burn-in The Plumbicon exhibits no, or very little perceptible picture sticking (burn-in) especially in highlights. The Saticon, on the other hand, has been observed to have a noticeable characteristic of "hanging-up" on bright highlights and also tends to exhibit picture sticking after a camera has been focussed on a scene for any length of time.

Registration The Plumbicon tube incorporates a precision gun assembly for controlled geometry and registration. Our final testing includes a computerized registration check which matches each tube's performance with a data base which includes readings on previously tested tubes. Should any tube fail to match up to this data base, it is rejected. This is added insurance that your camera will maintain precise registration even after you replace your original Plumbicon tubes. Needless to say, you *do not* have to replace the Plumbicon tubes in "sets."

Storage The Plumbicon can, of course, be stored for many months without deterioration. But why store TV camera tubes? Storage means money. Amperex service to the broadcast industry is justly famous. Delivery of replacement tubes anywhere in the USA within 24 hours is routine. In extreme emergency situations, we have shipped tubes clear across the country in as little as eight hours.

We expect you to make your own comparisons and we are sure your findings will agree with ours. One of the things that may not be apparent from your comparisons is the fact that Plumbicon TV camera tubes continue to stay abreast of the needs of the broadcast industry after more than ten years of production which has put almost 150,000 Plumbicon tubes into broadcast stations around the world.

When you specify Plumbicon tubes in your ENG cameras, we deliver a lot of experience.

For more information, contact:
Amperex Electronic Corporation,
Slatersville Division, Slatersville,
Rhode Island 02876.
Telephone: 401-762-3800.

Amperex®

TOMORROW'S THINKING IN TODAY'S PRODUCTS

A NORTH AMERICAN PHILIPS COMPANY



Circle 125 on Reader Service Card

900 series distribution switching systems

standard features

- vertical interval switching
- audio-follow-video [with tally]
- only two different modules used in the system
- complete module interchangeability
- less than 1° path length variation any input to any output to any size
- LED crosspoint status display
- fully expandable to any ultimate size
- computer compatible

Write for our users list.



American Data

401 Wynn Dr • Research Park
Huntsville, Alabama 35805
Telephone (205) 837-5180
TWX 810 726-2125

A North American Philips Company

ADC NORTHEAST
P.O. Box 452
New Hartford, CT 06057
(203) 379-7840

ADC MID-ATLANTIC
5504 Waterway
Rockville, MD 20853
(301) 460-1454

ADC WEST
3750 Cahuenga Blvd.
North Hollywood, CA 91604
(813) 760-3221

ADC SOUTHEAST
2219 Oakwana Rd. N.E.
Atlanta, GA 30345
(404) 633-2186

ADC MIDWEST
P.O. Box 22324
Indianapolis, IN 46227
(317) 784-3000

ADC N. CENTRAL
10700 Lyndale Avenue South
Minneapolis, MN 55420
(612) 887-1118

TELEVISION

PROGRAMMING & PRODUCTION FOR PROFIT

WHIP-TV's Battle Of Gettysburg: Low-Budget Production Wins Audience And Recognition

WHEN THE BUDGET for a production is restrictive, an enterprising programming department like that of WHIO-TV, Dayton, Ohio, can sometimes find a way to produce an award-winning show without leaving the studio.

"That can be crucial when the production is a documentary on an event that took place more than 100 years ago," says program director John Clark.

WHIO earned an Iris Award from the National Association of Television Programming Executives (NAPTE) and four regional Emmy Awards from the National Academy of Television Arts and Sciences for its 30-minute production of "Gettysburg: The Turning Point," a fast-moving, finely detailed portrayal of the Civil War battle, assembled almost entirely from old still photographs, engravings, and new artwork. These were copied on slides, 16 mm film, and videotape.

"Locally originated programming doesn't have to deal solely with local issues," Clark says. "Key events like the battle of Gettysburg affect

everyone, and it is important to understand them in perspective. We originally focused on Gettysburg as a way of explaining the reality of war to a generation of children who were too young to understand the Vietnam war when they lived through it."

Coproducer Sam Ellis conceived the Gettysburg idea when his 14-year-old daughter posed some probing questions about Vietnam. Ellis, who has a strong interest in Civil War history, saw the well-documented Gettysburg battle as a perfect vehicle for explaining the mechanics of war. But he felt an examination of the famous confrontation would appeal to more than just children.

"We soon found that even a half-hour recreation of the battle could be prohibitively expensive. There are Civil War mock regiments available to stage battles, but the logistics would have been horrendous," Ellis points out. "In addition, we were looking for something different from the many *You Are There*-style Gettysburg portrayals that have been done."

Much of the artwork was photographed with a 35 mm still camera. Other places were set on blue Chromakey cards and electronically combined with studio cameras

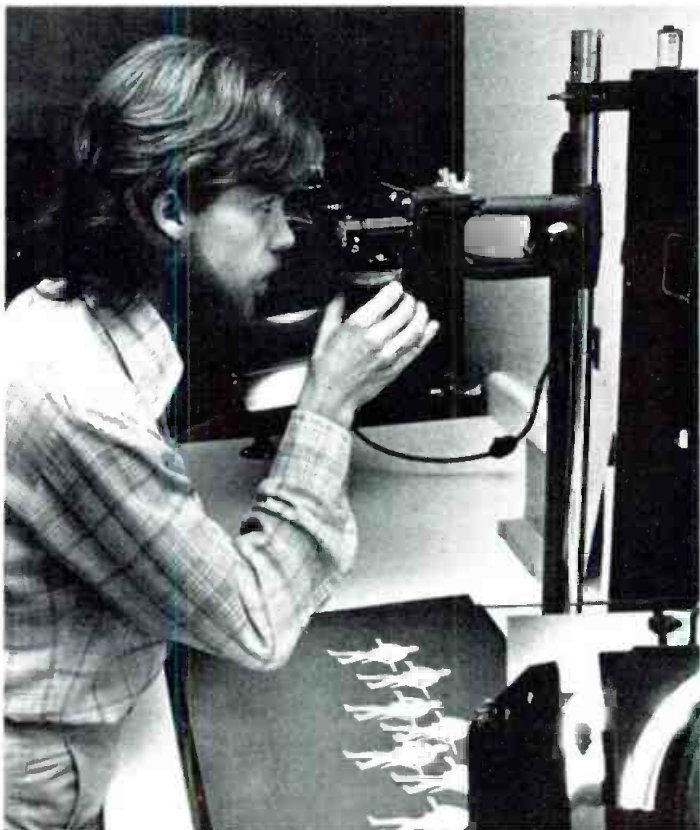

You can take this memory and STUFF IT.

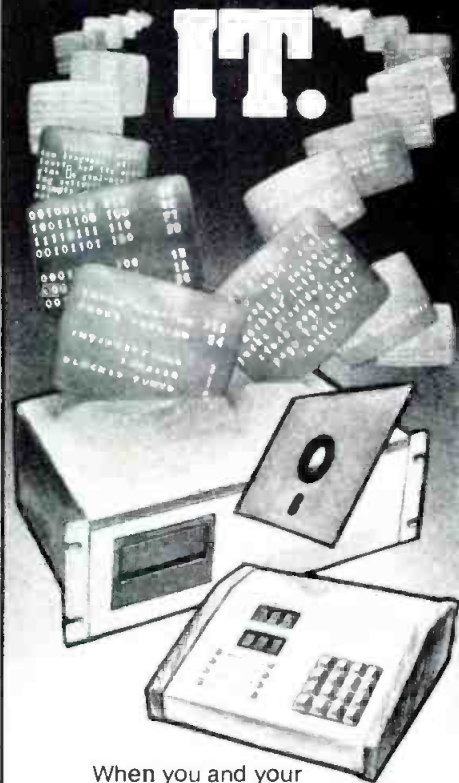

When you and your character generator have a lot to say ... long credit rolls ... sports stats ... lectures ... titling for the hearing-impaired ... the Knox KD128 disc memory system can hold 350 pages of it.

And it's programmable. With a single keyboard, you can create your copy and write a program — onto

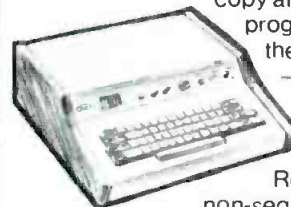

the same disc — that will completely cue the playback.

Roll or crawl non-sequential pages.

Have random pages recalled and displayed for a preset amount of time. All day, if you want.

Build a few pauses into the program if you need to get into it in real time.

You should see what you can do with it.

Call your Knox rep and you can.



A DIVISION OF COMPUTER OPERATIONS, INC.
9700-B George Palmer Highway, Lanham, MD 20801
301-459-2106

Circle 127 on Reader Service Card

BM/E SEPTEMBER, 1979 35

TV Programming



Sam Ellis, who produced the graphics for the show as well as writing the script and serving as coproducer, discusses some artwork with one of the station's artists



John Clark (left) and Sam Ellis, coproducers, examine some slides on a light table



John Clark checks on the electronic editing steps of "Gettysburg: The Turning Point"

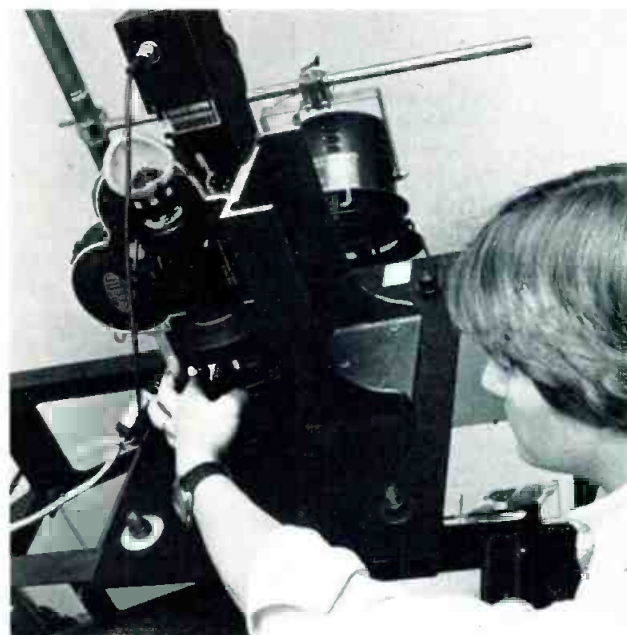

The slides were inserted into a holder on this copy stand and photographed individually on motion picture film, a frame at a time

Since there is an understandable shortage of "stock" film footage from the Civil War, Ellis and Clark decided to assemble the documentary from the extensive collection of photographic still material that exists from that period. Ellis began assembling non-copyrighted photos, paintings, and clippings from old newspapers. He wrote his script around this material, and then worked with the station's art staff to produce additional artwork to fill in the gaps.

The first sequences to be filmed were

the all-important battle scenes. The stills were first copied on slide film using polarizing filters to eliminate reflections on shiny artwork. The slides were then transferred to 16 mm film, one at a time.

The battle scenes, each lasting about a minute, were each filmed on continuous lengths of film. Ellis wanted no splices to interfere with the rapid-fire effect of the changing images. Ellis planned in advance how long each slide was to appear in the footage. Exposures for the individual slides were also cal-

culated. A given slide might be exposed for six frames at $f/11$ and the next for 10 frames at $f/8$. John Hirschman and Greg Wright of the WHIO-TV photography department worked very closely with Ellis on this effort.

In all, eight battle scenes were filmed on Eastman Ektachrome video news film 7240 (tungsten). Ellis used a variety of techniques to produce the illusion of motion. Rapid slide changes — a few frames apart — were important. Frequently the same piece of art was used in segments — long shot, medium

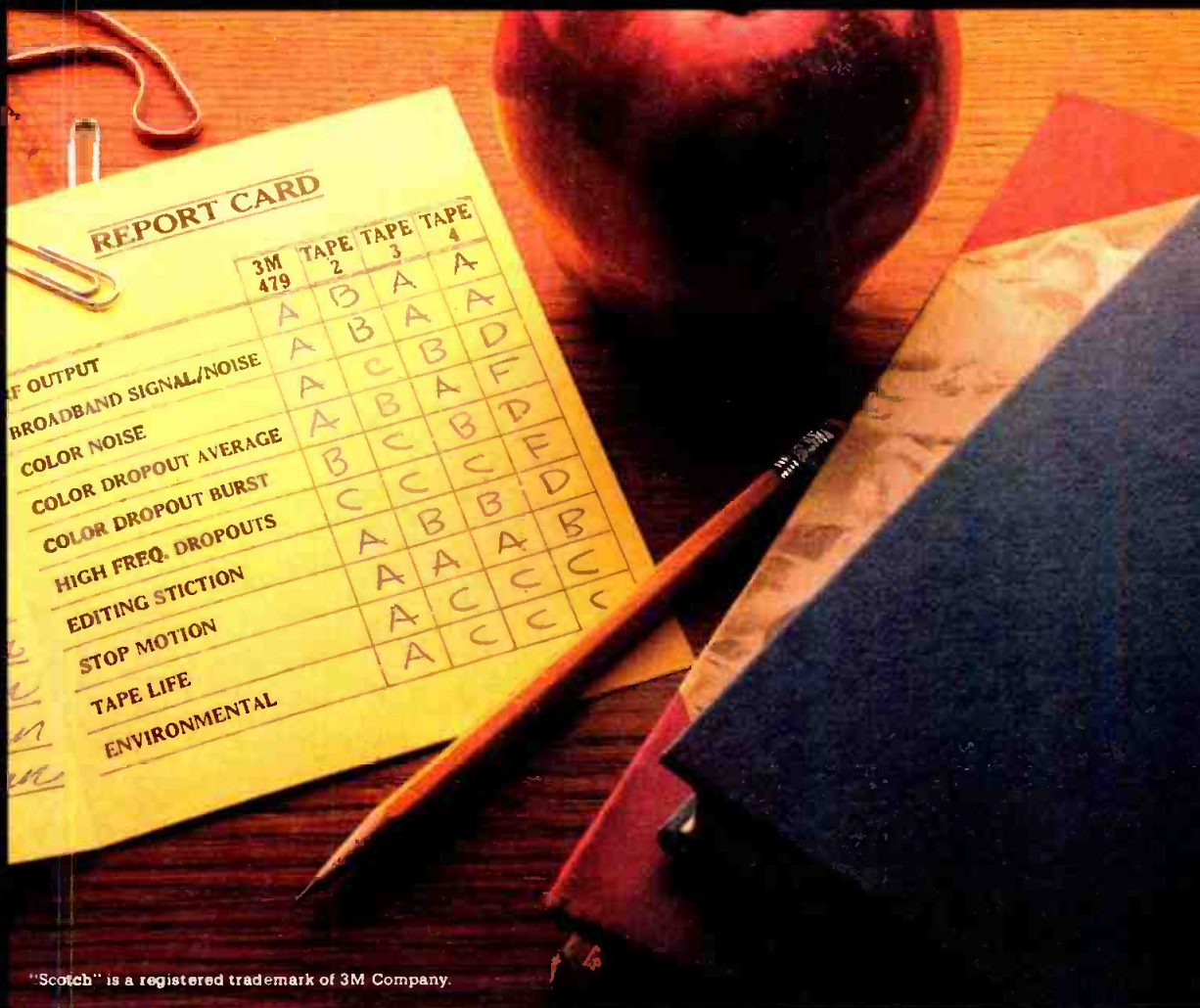

"Scotch" is a registered trademark of 3M Company.

IN A TEST OF ONE-INCH VIDEO TAPES, WE ACED OUT THE COMPETITION.

When we tested the top four brands under strict lab conditions, the overwhelming performance leader was Scotch 479 Master Broadcast Video Tape. In fact, we came out on top in all ten performance categories.

If that isn't reason enough to make us your choice, maybe this is. We're the only one-inch supplier that winds your tape onto a special cushioned flange reel to protect against shipping and handling damage. And we pack and ship our tape in a flame-retardant case to give you even more protection.

We're the people who pioneered the development of video tape 25 years ago. And according to the pros who know video tape best, we're still the best video tape. Give or take an inch.



3M

THE NETWORKS' CHOICE. (AND EVERYONE ELSE'S.)

At Camera Mart, we've been a leading equipment supplier to broadcasters and producers for years. We're no strangers to the 'instant' needs, unexpected calls, tough standards and difficult operating conditions that are often S.O.P. in this rough-and-tumble business. But you probably know that...at least, when it comes to film.

What you may *not* know is, for the past few years, we've been quietly doing the same in *video!* Testing and selecting the leading equipment for performance and reliability. And offering a wide selection of production and post-production components and packages—on rental, lease and purchase plans with our customary flexibility.

But don't take our word for it: talk to our customers. You'll see why so many people the industry depends on, depend on us.



40 years of excellence

Camera Mart

THE CAMERA MART, INC.

456 West 55th Street, New York 10019

(212) 757-6977/Telex: 1-2078

Sales • Service • Rental

NAB



Circle 128 on Reader Service Card

TV Programming

shot, and finally a closeup — to focus attention on some element, such as a wounded soldier.

Maps prepared by the art department had animated lines to show the movement of the armies. Ellis says a big worry was how well the black-and-white artwork would be reproduced on color film. Because the station is geared for color, shooting black-and-white slides and film would require more costly outside processing services. Ellis was pleased to find both the Ektachrome still and motion picture films excellently reproduced the black-and-white artwork. Blacks had no color cast in the darkest areas, and whites had no off-tint.

The finished film was transferred to two-inch videotape for editing. At this stage, Ellis combined the film with other scenes, taking advantage of some electronic editing features. Cutout artwork of General Lee, laid against a blue chroma key card, was superimposed on slides of Gettysburg that Ellis had taken on a visit to the battlefield several years ago. Similar electronic techniques combined other slides with titles and studio shots of narrator Ken Jefferson. The program's only live-action sequence was actor-director Ken Hardin's portrayal of Abraham Lincoln delivering the Gettysburg address at the end of the program.

As a result, the budget for the program was kept very low, Ellis notes. The production time was worked into the normal schedules of station staff over a three-month period.

"Public response to the program was remarkable. It attracted many more viewers than we had expected," Clark says. "Part of the reason was the military interest on the part of many of our viewers who live or work near Wright-Patterson Air Force Base." Another reason, according to Clark, was the universal theme of the program. Clark feels that a show produced for a local market does not necessarily have to be artificially "localized" by the gratuitous insertion of a "we here in Dayton" perspective. First, WHIO serves an audience much larger than metropolitan Dayton. Secondly, that perspective can limit the appeal of the program.

A number of stations in other markets have expressed interest in airing "Gettysburg . . ." but details of just how the show might be made available to the stations remain to be worked out. Nevertheless, Clark said, "That demonstrates how a show originally conceived as a children's program can grow into something a great deal more without becoming an expensive proposition for the station undertaking it."

BM/E



*Simulated pictures?

They're real.

But, if the printing press made as good an impression as Conrac monitors make, you probably couldn't tell.

Conrac's clarity and color consistency are the result of years of experience and technological depth. We were designing and manufacturing monochrome broadcast monitors before the first late-night host delivered a monologue.

And ever since color television began, Conrac's Colormatch™ has been the industry standard. Monitor to monitor, nobody's better at matching screen phosphors for identical color.

What's more, nobody offers a larger selection of broadcast monitors. Only Conrac covers the entire spectrum.

And since we're committed to the professional side of television, your needs get our full attention. Engineering conveniences like front-pull drawers for access to critical controls are standard on all Conrac color monitors. Modular construction assures



fast servicing, too.

Be sure to call or write for a Conrac Broadcast and Teleproduction Catalog. It features all our monitors, including the incredible Model 6100 with beam current feedback, independent convergence control and optional comb filter.

See why we still outsell everybody else six to one.

Conrac Division, Conrac Corporation, 600 North Rimsdale Ave., Covina, CA

91722, Tel. (213) 966-3511, Telex: 67-0437.



CONRAC

We're more than meets the eye.

Circle 129 on Reader Service Card

www.americanradiohistory.com

THE FULLY-AUTOMATIC STUDIO CAMERA. IT CAN AUTOMATICALLY SAVE YOU SET-UP TIME.

Think about the time it takes to set up studio cameras.

Think about standby time for talent and production crews waiting for your technicians to get the best picture quality.

Think about the savings if that time could be reduced from hours to minutes—or seconds.

The TK-47. The world's first fully-automatic camera.

The TK-47 studio camera performs sequential set-up functions automatically—at the touch of a button.

And it does it in a matter of seconds, rather than requiring the usual hour or two for conventional studio cameras.

Daily performance checks are also done automatically. And with



a Set up Control Unit, any number of TK-47's can be controlled—with truly consistent color rendition.

You get better utilization of technical people, a smoother operation, quicker problem-solving.

Inside the TK-47: RCA technology at its finest.

The TK-47 is filled with state-of-the-art technology. Extensive use of LSI's and digital memory circuits, for example. And we've eliminated troublesome potentiometers.

Everything in the TK-47 is designed to increase reliability, reduce downtime.

Automatically backed by RCA, and TechAlert.

Cost-effectiveness in a studio camera, or any other piece of equipment, depends on many things.

Quality. RCA has a reputation that can't be matched for reliable, enduring products and systems.

Service. Famous TechAlert service, and RCA parts support, can add years to the life of your equipment.

See your RCA representative, or write for details. RCA Broadcast Systems, Building 2-2, Front & Cooper Streets, Camden, NJ 08102.



**Cost-effective
broadcasting: we make
what it takes.**

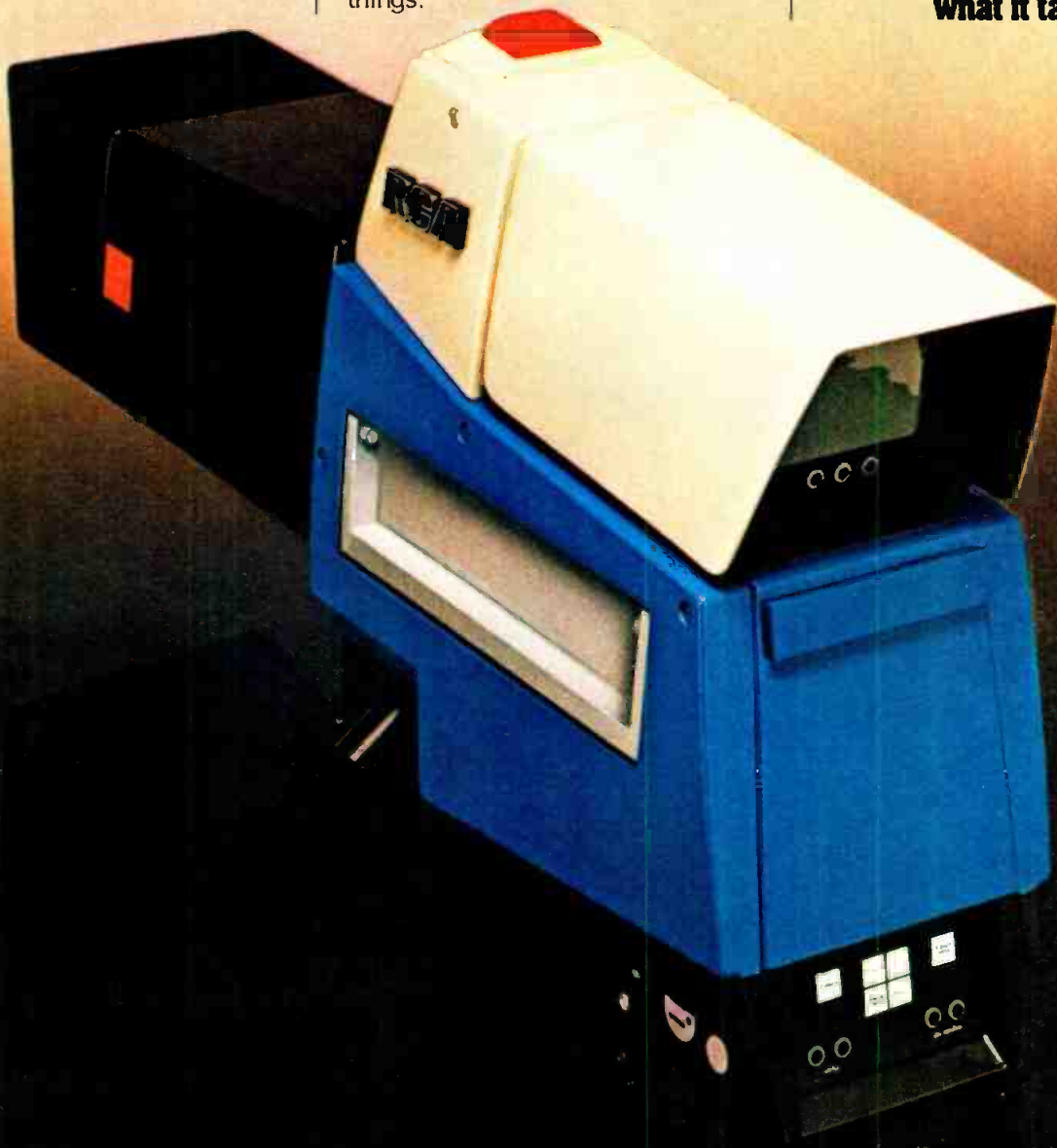

WRBR: 20th CENTURY TECHNOLOGY IN A 19th CENTURY BUILDING

By James M. Lies

When WRBR, South Bend, Ind., decided it needed to expand, it found a 125-year-old brewery fitted the bill aesthetically and economically. It proved technically advantageous, too.

STUDIO BUILDINGS need considerable immunity from noise and vibration. We found that the brick walls and concrete floors of the 100 Center, a former brewery which had already been converted into shopping, dining, and office space, provided the best isolation that could possibly be hoped for in an already-existing structure. The building's convenient location within the community and its pervasive charm (the oldest section was built 125 years ago) made it an ideal location for a radio station.

The building, which was to house the station's entire operation (both studios and offices), also offered the advantage that it was not situated near any industrial plants and was recessed some 500 feet back from the main traffic thoroughfare, further isolating it from noise and vibration. Two already-existing heat pumps were adequate for the anticipated heat load (with the addition of some ductwork) and would be capable of wintertime heating without difficulty. Adequate ac power was available for our use.

Our plans called for maximizing the large floor space, which was interrupted only by two brick walls running the length of the area and supporting the floors above. We needed offices for eight management-level people, the sales department, disc jockeys for our Top 40 format, and a receptionist, plus a lobby and three studios. By grouping the office manager, traffic, and continuity in one area, the general manager, sales manager, and sales people in another, and locating programming and engineering near the operating areas, we found we had space left over for a large conference room and a vending machine/refreshment lounge.

Wiring made use of existing race

Wiring commenced with the start of inside carpentry. The air monitor went in first because it would be partially routed through the walls and ceilings. Fourteen speakers were located on the floor plan and a "backbone" was laid to distribute the audio. The speaker volume is individually controlled with T-pads and limited with resistors which bridge the backbone. The system is fed at about 1.2 ohms and works extremely well. I estimate the savings over having installed a 25 volt distribution system at about \$300.

James M. Lies is chief engineer of WRBR-FM.

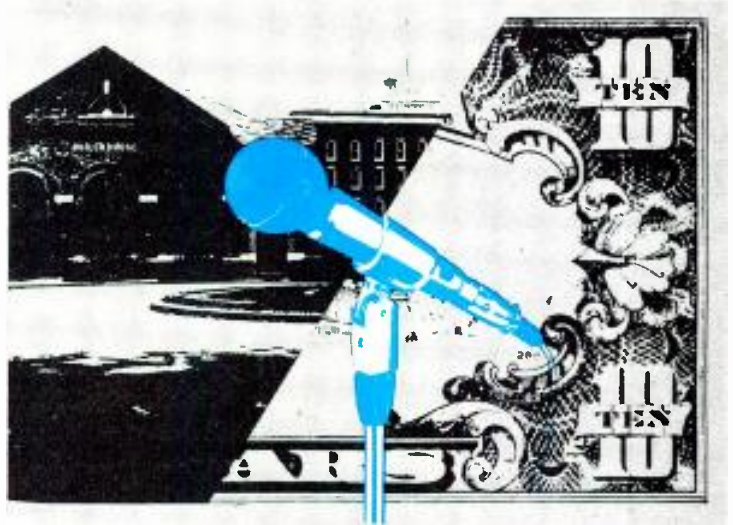

Inter-studio wiring and lines leaving the building were laid next. Enough of these were planned to cover both current and future needs, with spares installed where feasible. The spare remote control line, for example, was backed up with an eternally vigilant security alarm; the line can be disconnected from the alarm when needed for emergency remote control. Outside lines are terminated near the telco board location.

The east wall, running by the studios, had a large existing floor-level race formerly used for ac distribution. It was too convenient to pass up! We dropped a large bundle of inter-studio level audio lines into it, along with the station ground strap, dc, intercom, and remote control. Audio was kept near the top; new ac conduits and the telephone lines were kept with the old ones at the bottom with RF for RPU, public service, and two-way radio. When lines of dissimilar purpose had to cross, they did so at right angles to minimize pop and hum pickup. The race was then tightly packed with insulation where it left each studio. Wiring that stayed within a room was kept inside the studio furniture so that no equipment racks were required.

Staggered-stud wall construction

Walls surrounding studios were of double-frame, staggered-stud construction with insulation blankets



The newsman can see any cues, time, even the weather from this vantage. During news, he will run his own voice inserts, mic level, even the commercials



WRBR's control room/main studio was designed for convenient remote operation off all equipment

woven between frames. Inner and outer walls were never allowed to contact each other directly. The frames were covered with ½-inch sound board, then drywall. The existing brick wall (forming the east wall of each studio) and the 2x14-inch beams holding the west wall helped keep vibration down, though the brick wall did have a slight tendency to pass vibration from the heat pumps on its other side.

The window between the control room and the newsroom proved a bit problematic. Because of the required viewing angle and the small size of the wall, we were unable to make the two pieces of glass very dissimilar in shape. The result was that the window became resonant and voices could be heard distinctly through the window. The solution was to choose two different thicknesses of



While rigging the (tapered) chimney for hoisting heliax, riggers have to climb what feels like the wrong side of a ladder 165 feet, in the dark

glass and to mount them in such a way that the inner and outer walls did not contact each other through the window frame. This kept the resonating frequencies of the pieces of glass distinct and severely reduced their transmission.

Ceilings were built on sound board with insulation laid above. Both tile and dropped ceilings were used. This helped maintain the 2⅓ dimension ratios in the control and production rooms despite differing ceiling joist sizes. Solid core doors with weatherstrip made a quiet entry for each studio. Air conditioning was brought in and out by fiberglass ducts which *completely* remove blower and duct noises as well as maintaining room-to-room isolation.

With the exception of the newsroom, which had to be narrow to accommodate the news director's office, studios were planned to keep resonance from being reinforced. Reverberation time initially was planned to be a little than normal due to our plan to use cardioid microphones; later, anticipating the eventual heavy use of audio processing, we cut reverberation time shorter than normal. The rooms were sized and surfaced identically where possible so that an on-air live personality does not sound too different from a prerecorded tape.

Flexible studio design

The facilities are extremely flexible. Each operating area is self-sufficient, and each is fully backed up. The production room is an emergency control room and also an extra newsroom. Commercials can be produced in the newsroom. Any of the studios can be put on the air directly if convenient or necessary. The embarrassment of a console or power failure in the newsroom during live newscasts can be overcome by plugging a microphone into a wall plug connected to the control room console. Public affairs, handled by the news department, often

the new CD-480-4 another smart switcher from CDL

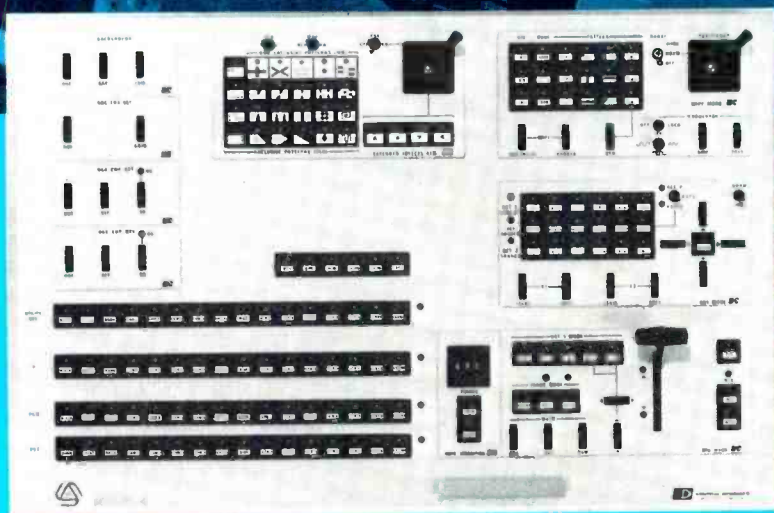

compact, competitive and powerful

The power of the CD-480-4 plus its compact size and price make it the professional choice for medium size studios, post production suites and mobile vans.

Powerful: includes the unique CD-480 SFX amplifier that permits you to control 4 video signals, in any combination, with one fader handle, plus a wide range of powerful CD-480 modular options.

Compact: 24" wide panel and 21" of rack electronics.

Price: Also compact and competitive . . . ask us.

The CD-480 gives you the competitive advantage.

Central Dynamics, 10 W. Main St., Elmsford, NY 10523, 914-592-5440
Chicago: 312-991-4720, Los Angeles: 213-789-0574, Atlanta: 404-491-9037
Dallas: 214-741-3332, Denver: 303-623-7603, CANADA-Montreal: 514-697-0810

CENTRAL DYNAMICS



Circle 130 on Reader Service Card

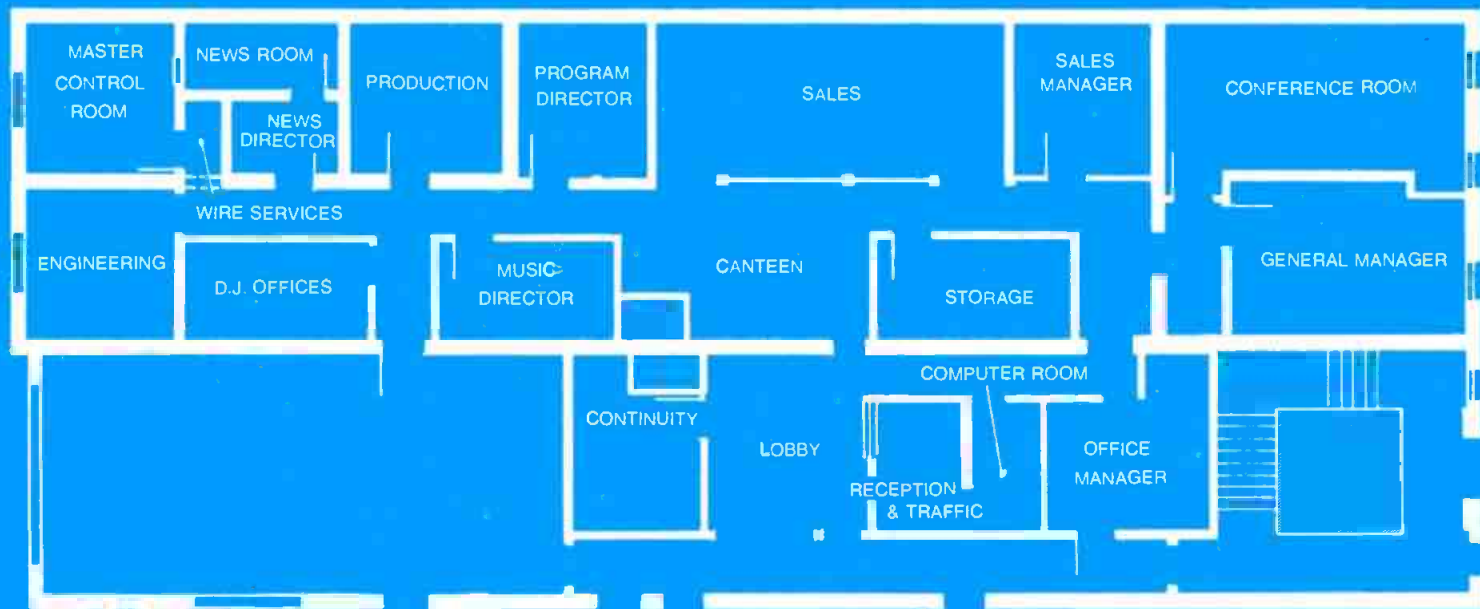

Floor plan. The thickest walls are the existing brick barriers. Square representations in the wall sections near the top are large wooden posts supporting ceiling beams and the floors above

requires interviews; these can be conducted in the news room, news director's office, or in the conference room when there are a large number of guests. The newsroom's recorder is generally used, but Production can also tape a program originating from any of these locations. The newsroom has an unusually high number of speakers; "mute box" quiets all of them in the presence of any live mic.

STL/remote transmitter operation necessitated

Since the 100 Center could not house a transmitter, plans for an STL and remote transmitter facility were made. On a map I drew an arc that included sites from which we could provide a city-grade signal to South Bend, and a "preferred region" to deliver this signal to as many suburbs as possible. The map indicated two possibilities. One, on the highest terrain, unfortunately did not offer us coverage of a well-populated portion of our Metro Survey Area. We therefore went with an area with the second highest average terrain level AMSL.

Having chosen a transmitter site, we could establish the STL site. The 100 Center would not accommodate a tower tall enough to get an STL signal to the transmitter free of Fresnel effects. The only site in the complex high enough for the job was the old Boiler House chimney which, fortunately, was no longer contributing to air pollution. We installed the heliax inside and up through the chimney cap to a single antenna mounted on the side of the structure. The STL transmitters were housed in a projection booth of the theater into which the boiler room had been converted. This provided a secure but accessible STL location as well as a short coax run.

The remaining project at the studio end of the hop was to route audio and remote control from the studio 450 feet to the projection booth. Conventional audio line would roll a 600 ohm feed off nearly 3 dB at 15 kHz! We could

feed the cables at 150 ohms, of course, but to maintain a flat response down to 30 Hz requires fairly costly transformers. Further, there is always the phase shift problem. Low-capacitance audio cable was my solution. Two audio channels and one combination remote control/carrier status indication line were installed. The high frequency drop measures less than .25 dB at 15 kHz. The STL transmitters are housed in a home-built box similar to a short equipment rack, with a fan installed in the top rear and a sliding plexiglass cover locking the front.

The transmitter building was constructed of concrete block and has an insulated frame roof. The blocks and floor were sealed after construction to prevent concrete powder from contaminating the equipment. The transmitter provides much of the building's winter heat; in summer, ridge vents and a thermostatically-controlled fan exhaust this heat. Vents near the floor provide inlet air.

When the concrete floor was poured, an electrical trough was laid under the site for main and auxiliary transmitters and equipment rack. This same trough can service any future racks for example, equipment using leased tower space. The equipment installed allows remote control of transmitter changeover. Hardware welded onto pipe sections which support a four-inch conduit forms a transmission line carrier capable of protecting lines to the tower from falling ice and, we hope, from agile trespassers. The carrier and lines pass through the barbed wire topping on the tower fence. We designed an infrared alarm to advise studio personnel of anyone climbing the tower. Finally, the guy anchors have tall fences topped with barbed wire, tipped outward, protecting them.

With some planning, foresight, and a measure of luck we have created a broadcast plant in interesting surroundings which has received critical acclaim from other broadcasters, advertisers, and lay people in the community.

BM/E

When does a portable color camera become an affordable studio camera?



When it's a Panasonic ENG/EFP camera.

Now you can stop admiring ENG/EFP color cameras, and start owning one! The surprisingly affordable Panasonic AK-750. Thanks to its impressive list of options, our three-tube Plumbicon® portable camera doubles as a studio camera.

In the field it's a fully self-contained portable camera that weighs only 20 lbs. (with our optional 12:1 zoom lens shown), so it's easy to handle. It's just as easy on the power, using only 23 watts. You can interface the AK-750 with any EFP system, because it can be externally synchronized with a single cable. Timing and phase adjustments are built right into the camera head. Or connect it to any studio system, simply by adding the optional Remote Control Unit and studio viewfinder.

Indoors or out, you can look forward to impressive performance: With an S/N ratio of 49 dB, and horizontal resolution of 500 lines center at the recommended illumination of 200 footcandles at f/4. There's even a +6 dB gain for a minimum illumination of just 15 footcandles at f/1.8.

Some impressive circuitry was built into the camera: Like a Y I/Q encoder, an RS-170A sync generator with genlock for studio or EFP use, and a color bar generator.

It also features an optical black, and automatic white balance. And there's electronic color conversion, as well as a filter wheel behind the lens.

Horizontal and vertical blanking are both adjustable to meet a variety of recording or playback requirements. And your picture is always crisp and clear thanks to horizontal aperture correction and 1-line vertical aperture correction built right into the camera head.

Not only do you get a long list of standard features with the AK-750, there's also a long list of camera options available. Such as 2-line vertical aperture correction, a chroma key unit, and more.

So if you're pricing both studio cameras and portable cameras, price one camera that can do both. The Panasonic AK-750.

Plumbicon is a registered trademark of N.V. Philips of Holland for TV camera tubes.

For more information, write: Panasonic Company, Video Systems Division, One Panasonic Way, Secaucus, N.J. 07094. In Canada, Panasonic Video Systems Department, Mississauga, Ontario.

Panasonic

just slightly ahead of our time.

Circle 131 on Reader Service Card

FREE* FOR

AUDIO CONSOLES (The Silent Series)

DC-38: 5, 8 or 10 mixers, up to 40 inputs: \$2,447 to \$4,980.



SC-5, DC-5, DC-8:
5 & 8 mixer, 12 to
18 inputs: \$995 to
\$2,375.

P5M: Portable; 5
mixers, 8 inputs; built-in
compressor: \$545.

DC-12: Remote
control; up to 12 mixers
(expandable to 20) with 2 inputs
each: \$4,200 to \$5,200.

THE PHASE-ERROR-FREE CART PRODUCTION CENTER

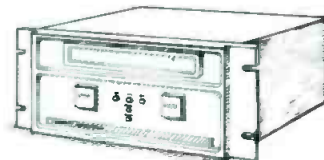

(Demos now,
deliveries Jan/80)
PhaseMaster:
Phase-error-free
record/reproduce/duplicate
full complement of
broadcast features and
construction.

MA Series: Studio
monitors: 12 W mono, 20
W stereo; 10 Hz-50 kHz ± 1
dB; distortion 0.05% max:
\$121 and \$171.

MIC/LINE/STUDIO AMPLIFIERS:

SMA Series: Studio monitor: 25 W rms/ch.
stereo; 15 Hz-50 kHz ± 1 dB; distortion
0.6% max: \$325.

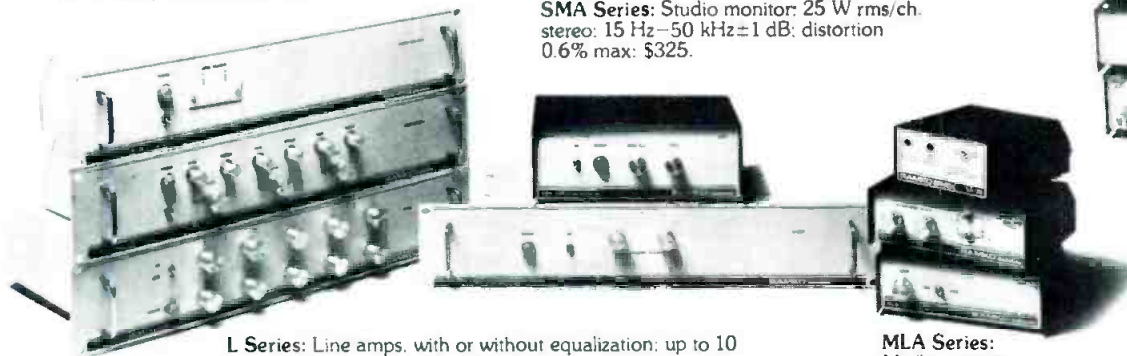

L Series: Line amps. with or without equalization; up to 10
mono, 5 stereo ch.; solid-state balanced and unbalanced
inputs: +21 dBm max, in and out; response 10 Hz-50 kHz
+0, -1 dB; distortion 0.008%: \$135 to \$453.

MLA Series:
Mic/line inputs;
studio or remote:
\$128 to \$185.

DML Series:
Dual mic in to
amplify, mix, limit and control
gain; built in compressor; AC
and DC: \$239 to \$281.

AUDIO ROUTER/AMPLIFIER

ARA-1612: Up to 16 in, 12 out, LED status display:
\$1099 to \$2296.

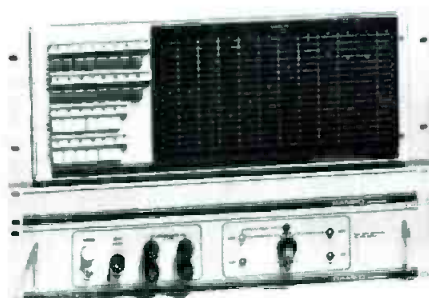

TURNTABLE PREAMPLIFIERS
MP-8 & SP-8: Mono & stereo; S/N
-77 dB; ± 1 dB RIAA: \$98 & \$144.
ESP-38: 0.03% distortion; S/N
-85 dB; ± 25 dB RIAA: \$325.

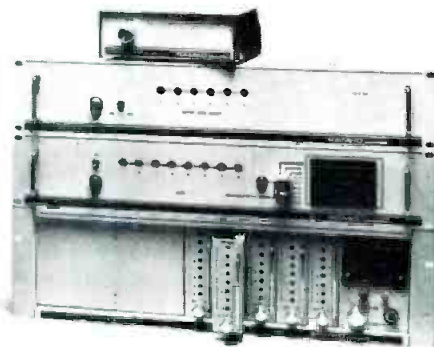

AUDIO DISTRIBUTION AMPLIFIERS

DA Series: 12 versions from 1 x 30 mass feed to 20
x 80 rack mount; 20 Hz to 20 kHz ± 0.5 dB; -75 dB
separation: \$145 to \$2276.

Prices subject to change without prior notice.

2 WEEKS.

*You can use any of the gear you see free for 2 weeks (with credit approval prior to shipment).

Play with the cart/cassette record/playback/duplication center that eliminates stereo phase shift error once and for all. The most advanced turntable preamp in captivity. Consoles so advanced, so silent you're not going to believe them until you try them. Or an audio router that makes whatever you've got now look—and sound—like so much spaghetti.

Then, if it's not for you, just ship it back.

But in all fairness, we have to warn you—once you've tried Ramko, chances are you're hooked for life.

Phase shift doesn't matter in mono.

So instead of adding failure-prone electro-mechanical components or re-inventing the cartridge, in the Ramko PhaseMaster Cart/Cassette Duplicating Center, we simply encode the stereo before it ever sees the heads or tape, then decode the signal after it leaves these two major sources of stereo phase shift error.

The result is phase-error-free recording/reproduction/duplication, and performance specifications that meet or exceed whatever cart drives you're using now.

Features include: an A and B cart deck; an A cart deck; and a cassette deck. Simple cassette-to-cart(s) and cart-to-cassette duplication. Automatic switching of record/playback, encoding/decoding and mono/stereo. Left, right and phase analysis meters. Front panel input selection. Three cue tones. And so much more that you'll just

have to contact us for details and a demonstration.

Ask for the Ramko PhaseMaster.

Just another turntable preamp?

Look at what one user wrote:

"Three days ago I replaced the (brand name) preamps in our studio with your ESP-38 preamps."

"The result was astounding. The next day we had six unsolicited calls from local stereo stores. All commented on our improved disk reproduction and wanted to know what we had done."

"The comments from listeners have been excellent."

Try it. You're going to like it a lot.

For AM stereo, or an FM station upgrade.

Ramko consoles come with features you won't even find in more expensive competitive units.

Total dc control of all mixing and switching function means no more noisy pots and switches, no stereo tracking error, and much more resistance to RFI.

We've developed solid-state balanced inputs for better sound. Added gain select on each input. Included switch-programmable cue and monitor mute selection. Provided mono, stereo and phase meters as standard features.

And then we backed everything with a 2-year warranty (4 years on the DC-38 and DC-12).

Kiss your patch panels good-bye.

Because with the Ramko ARA-1612 Audio Router/Amplifier you use front panel pushbuttons to route 16 inputs to any of 12 outputs, simultaneously or individually, with an instant LED display of what is

going where. You've never seen anything like it.

IC switching and isolation buffers mean no loading and no degradation of S/N or frequency response with multiple feeds (stack them for up to 45 in and thousands out). On-board switches change stereo to mono instantly. Individual gain control on all inputs allows precise level matching. Frequency response is 20 Hz–20 kHz±0.5 dB; S/N is –75 dB; distortion <0.3%; and input/output levels are +21 dBm max.

And all this is yours at the lowest cost per crosspoint in the industry.

The music goes 'round and 'round...

For moving sound around, we offer more different kinds of amplifiers than anybody.

Ten models of Audio Distribution Amplifiers, each with 10 Hz–20 kHz±0.5 dB frequency response, less than 0.1% distortion, and more inputs and outputs for the size and price than any other comparable ADA.

Four different Line Amplifiers with 20 Hz–50 kHz±0, –1 dB frequency response, 0.008% distortion, balanced in and out, and +21 dBm max out.

Portable and studio dual function MIC/LINE amplifiers with balanced in and out, built-in RFI suppression, 20 Hz–20 kHz±0.5 dB frequency response, gain from 64 dB on MIC to 26 dB on the high level channels, and distortion at an inaudible 0.1%.

And isn't that music to your ears?

To hear more, contact: Ramko Research, 11355 Folsom Blvd., Rancho Cordova, CA 95670.

Or just call (916) 635-3600 collect today.

RAMKO
Brains, not brawn.

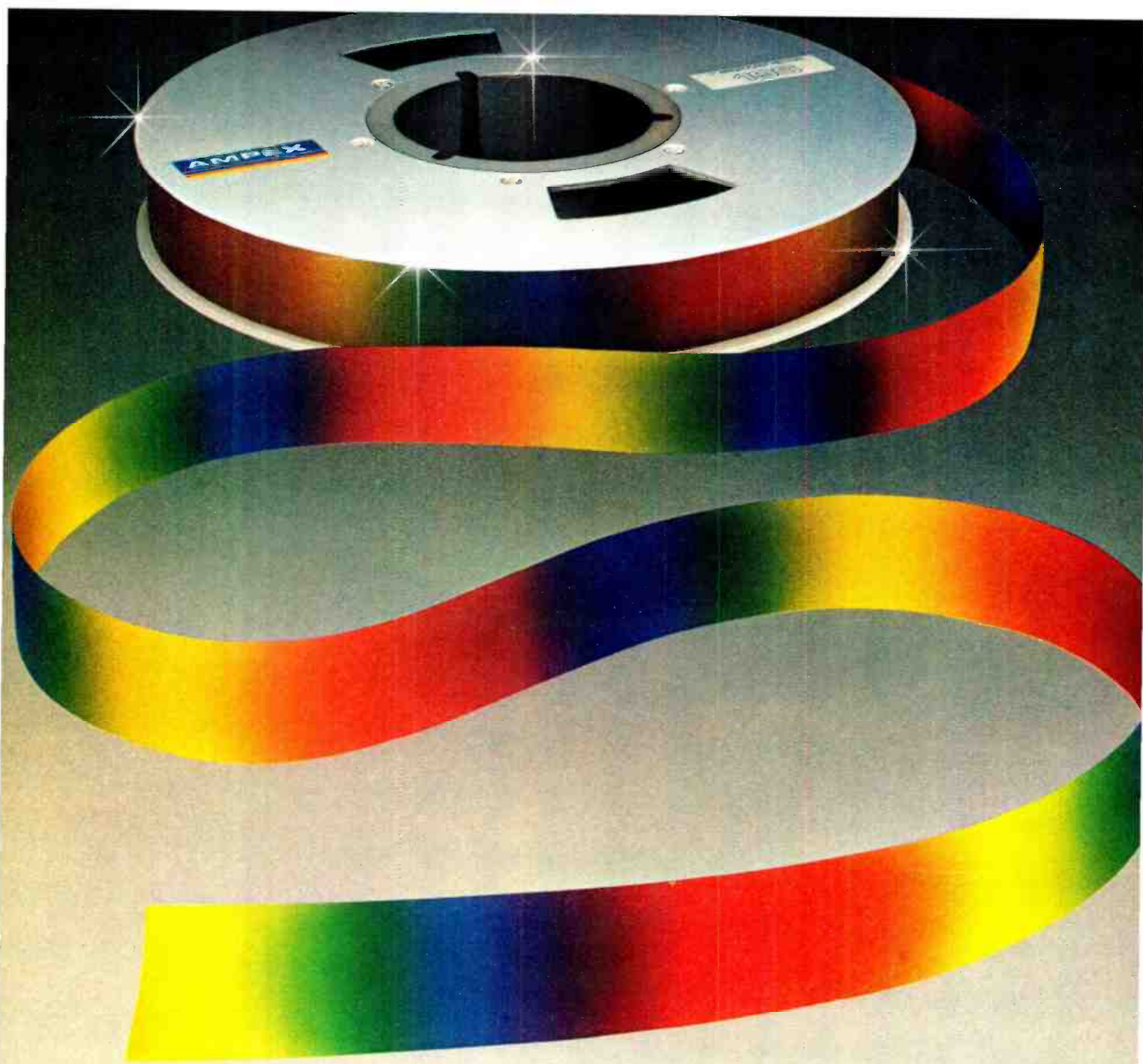

STATE OF THE ART

AMPEX 196 SERIES BROADCAST 1" HELICAL TAPE

This is the tape Ampex *had* to design to demonstrate the fantastic capabilities of our VPR-2, the machine that is revolutionizing professional video recording.

With Series 196, color brilliance is preserved and signal-to-noise ratio is unaffected even after multiple playback passes, lengthy still framing and heavy post-production editing. This tape is the ultimate match for the VPR-2—a brilliant combination

that is unsurpassed in today's video recording industry. Available in SMPTE Type "C" or "B" formats. 34 min/66 min/94 min.

Contact Ampex Corporation, Magnetic Tape Division, 401 Broadway, Redwood City, CA 94063, 415/367-2011.

AMPEX



OFFICIAL SUPPLIERS VIDEO RECORDERS AND MAGNETIC TAPE XXII OLYMPIAD

Circle 133 on Reader Service Card

REHAB TAX BONUS

By Mark E. Battersby

If you're considering expansion, renovation, or upgrading your facilities, Uncle Sam has promulgated some tax laws that make older structures a wise prospect for rehabilitation.

HAVE YOU EVER given any thought to profiting from your silent partner — the United States government? It should not come as any surprise to learn that Uncle Sam has, for years, picked up the tab for 10 percent of your new equipment purchases. But did you know that now that same investment tax credit also applies to the costs of fixing up your station and studio?

That's right — effective October 31, 1978, you could reduce your firm's tax bill by 10 percent of any sums spent rehabilitating an old building. And, what's more, the same Revenue Act of 1978 also contains special rules helping clarify other types of property that can qualify for the investment tax credit, thereby making it easier — and more profitable — than ever to use the investment tax credit on your next tax return.

First, the new law now permits you to claim the investment tax credit for rehabilitation expenditures incurred in connection with any building — office, warehouse, transmitter building, or studio — that has been in use for over 20 years. What's more, you or your company do not even have to own that building in order to claim this investment tax credit. Since the credit is based on "rehab" expenditures, even tenants are eligible.

Specifically, the new rules state that any physical rehabilitation must commence at least 20 years after a building is placed in service in order to qualify for the credit. Thus, you may claim the investment credit for rehabilitation expenses only once every 20 years for any particular building.

We all know that buildings and their structural components do not qualify for the investment tax credit, although their costs may be recovered through depreciation. However, with the addition of this new rule, it is now possible to reap a bonus equal to 10 percent of the cost of rehabilitating your studio or even converting another old building into a facility to accommodate your growing activities.

The principal restriction here prevents you from rehabilitating any residential buildings. It is the ultimate use

Mark E. Battersby is a Tax & Financial Consultant specializing in broadcast operations. He works in Ardmore, Penn.

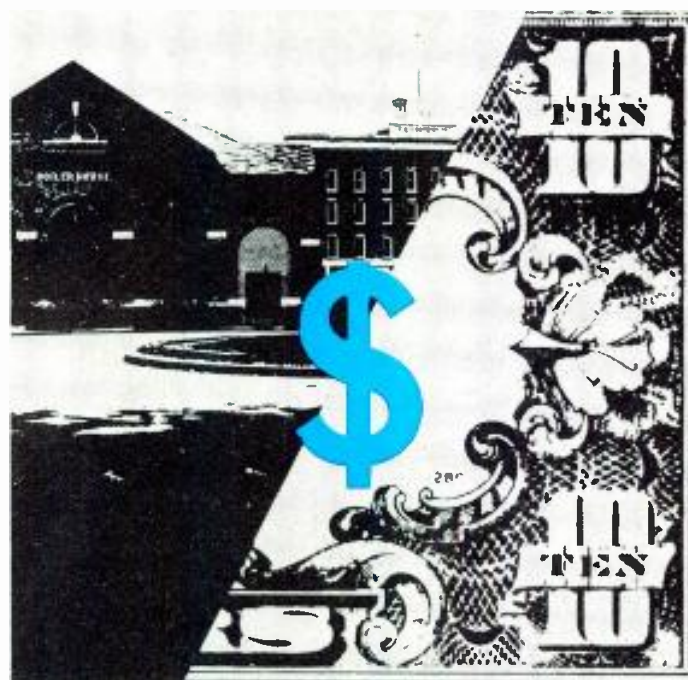

of the building, however, which determines whether it qualifies for the tax credit. In other words, you may convert a house into a studio or an apartment building into something more suitable to your operations and still qualify for the new credit — but not vice versa.

If more than 25 percent of a building's walls are replaced, it is not considered to be rehabilitation under the new law. But this limitation does not apply in situations where existing walls are merely covered with new siding as part of the general rehabilitation. Nor does it apply if remodeling results in more than a 25 percent increase in the floor space of your studio building.

Along the same lines, the costs of acquiring a building or even acquiring an interest in a building are still not considered to be qualifying expenditure, nor are the costs incurred for other facilities such as parking lots. Completing a new building after it has been placed in service will not qualify for the credit either.

Rehab Tax Bonus

Generally, the rehabilitation of any building, factory, or warehouse will include renovation, restoration, and reconstruction expenses. Thus, interior or exterior renovation or restoration that helps extend the useful life of your studio, upgrades its usefulness, or aids in preserving it, qualifies for the tax credit. Other capital expenditures for the replacement of plumbing, electrical wiring, flooring, permanent interior partitions or walls, and the heating and air conditioning systems (including temperature control systems) would also qualify as rehab expenses when incurred in connection with a rehabilitation.

Anyone who has ever looked at our present tax law knows how difficult it can be to classify some items as either "tangible personal property," which is eligible for the investment tax credit, or as "structural components"

of a building, which are ineligible. When connected with qualified rehabilitation, however, these classification problems are virtually eliminated because they are eligible for the new credit either way.

In addition, expenditures for the removal of existing interior walls, plumbing, electrical wiring, flooring, etc., would qualify for the rehab tax credit as long as they were incurred in connection with the actual rehabilitation of a building. They must, of course, be treated as capital expenditures for property and have a useful life of at least five years.

This does not mean that all rehabilitation expenses must automatically be lumped together to qualify for the investment tax credit. If your tax strategy is sufficiently sophisticated to permit you an accelerated tax write-off of any specific rehabilitation expense as some other type of expense, you are free to choose the path that will benefit you the most.

However, qualified rehabilitation costs are to be treated as incurred for new property and, therefore, not subject to the \$100,000 used property limitation — except when such costs are for property (such as used elevators) which otherwise qualifies for the investment credit. In other words, those rehab costs which were denied the tax credit under the old law qualify as "new property" with the accompanying higher ceilings on the amount which may be claimed. Items which were eligible for the credit prior to the rule change but which may be a part of your total rehabilitation bill will, under these rules, still be subject to the ceiling for used property — if they actually are used.

The law now permits you to claim the investment tax credit for expenditures for renovation, restoration, or reconstruction of a 20-year old building as long as the actual rehabilitation has at least a five-year useful life. However, to exclude relatively minor repairs or improvements, the costs upon which this credit is based must be capitalized (and not deducted as current expenses) on the tax return.

In actual practice, qualifying rehab expenses will be eligible for a two-third investment tax credit if the improvements have an estimated life of five or six years, and a full amount when the useful life is seven years or more. The so-called "useful life" is, naturally, the same period used for depreciation purposes.

Obviously not everyone occupies a building that is more than 20 years old or will want to renovate it if they do. That doesn't mean that they should neglect the many advantages of the investment tax credit, however. After all, what other area of our tax rules allows you to actually pay out only 90 cents for every dollar in equipment acquired?

That is the actual out-of-pocket effect of the investment tax credit both before and after the passage of the Revenue Act of 1978. You purchase qualifying equipment and depreciate or write off its entire cost on your tax return over the years it is in use. Plus, as a bonus for helping the economy by acquiring that property, our lawmakers will allow you a special amount in addition to the regular and first-year depreciation allowances equal to 10 percent of that property's cost.

The new rules allowing the investment tax credit to be claimed based on rehabilitation expenditures are pretty clear-cut. Unfortunately, in the past many people tended to shy away from the credit because they were not always certain whether specific types of property qualified. Most of that confusion has now been resolved with the inclusion of special rules in the new tax law that help clarify just

According to some experts, an old building can be purchased and rehabilitated for only 70 percent of the cost of a new building constructed today. Based on a new building life of 50 years, the following illustrates the effect on the average tax return:

	New Building	25-Year Old Building
Cost	\$ 100,000	\$ 30,000
Renovations	—	40,000
	100,000	70,000
First Year		
Actual out-of-pocket expenses		
25% down payment	25,000	17,500
Balance financed at 12%/20 years first year repaid principle and interest.	9,585.72	6,936.84
TOTAL	34,585.72	24,436.84
First year write-off		
Depreciation (straight- line, no salvage value)	2,000.00	2,800.00
Interest Expense (Avg. over loan period)	5,836.92	4,311.84
Investment tax credit (value at max. corporate tax rate)	—	8,333.00
	7,836.92	15,444.84
Net Out-of-Pocket First Year Expense	26,748.80	8,992.00
	New Building	25-Year Old Building
Subsequent years:		
Debt Service	\$ 9,585.72	\$ 6,936.84
Write-off		
Interest expense	5,836.92	4,311.84
Depreciation	2,000.00	2,800.00
	7,836.92	7,111.84
Net Out-of-Pocket Expense	1,748.80	(175.00)

SONY INTRODUCES WIRELESS MICROPHONE SYSTEMS WITH AN INNOVATION NOBODY ELSE HAS: SIGNIFICANTLY BETTER SOUND.

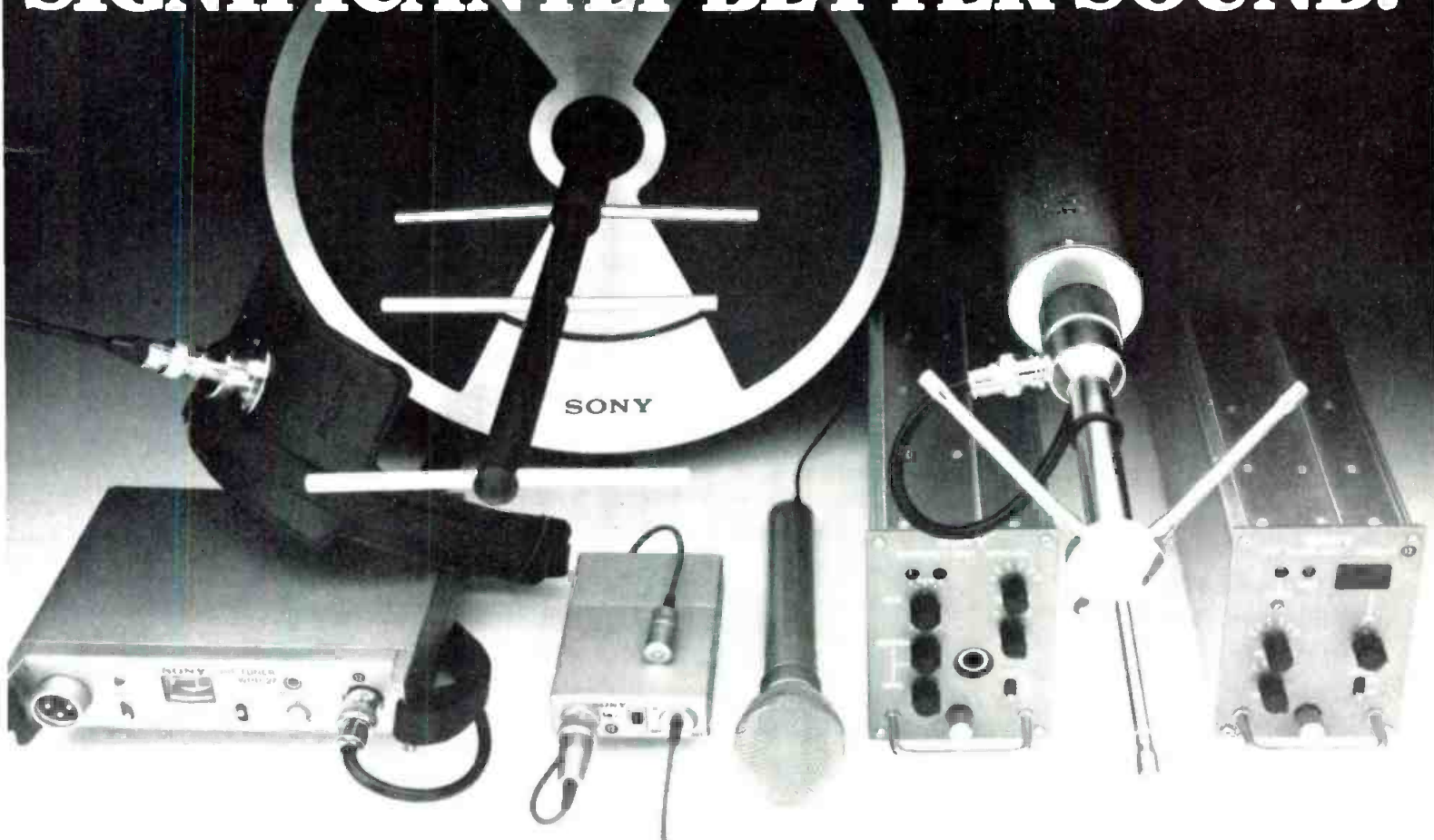

Until now, using a wireless microphone system meant sacrificing the quality of the sound in a trade-off for portability.

No more.

Sony has engineered wireless microphone systems as portable and versatile as any on the market.

But with a very big difference. Excellent sound.

To begin with, Sony offers a wider dynamic range than any other wireless system, a range of 96 dB. This accommodates sound pressure levels up to 130 dB. (While most other wireless systems have limiters which hold their dynamic range to, at most, 75 dB, Sony engineering has produced a system that requires no limiters.)

So what goes into the microphone comes out again at the same sound level. And nothing takes away from the thrill of performance.

What's more, audio distortion is less than 0.1% and signal-to-noise ratio is better than 57 dB (both ± 2.4 kHz deviation, at 1 kHz).

And the new Sony systems are virtually drift-free. Frequency stability is an amazing $\pm 0.005\%$.

Furthermore, Sony wireless systems are available with up to 14 channels in UHF, which means that interference from other sound sources is much less likely than at lower frequencies.

And while many wireless systems are put together with a mixture of components from several manufacturers, Sony uses only one: Sony.

So we've been able to create fully integrated systems that offer you a wide variety of options.

For EFP and ENG, Sony's system includes a tiny lavalier mike, a transmitter about the size of a cigarette

pack and a tuner smaller than a paperback book.

The system also comes with a shoulder-strap antenna and a leather carrying case. Altogether, it's compact and efficient and offers outstanding sound.

For studio and stage use, Sony has a modular rack-mounted system that can be engineered in any combination you want, from single-channel to multi-channel diversity reception.

It can be portable or fixed, and runs from 110 volts AC or 24 volts DC.

For more information, call Sony Professional Audio Products at (212) 371-5800, extension 143 or 145.

You'll find out that no other wireless systems sound as good as Sony's.

SONY

We've never put our name on anything that wasn't the best.

MORE... FOR LESS!

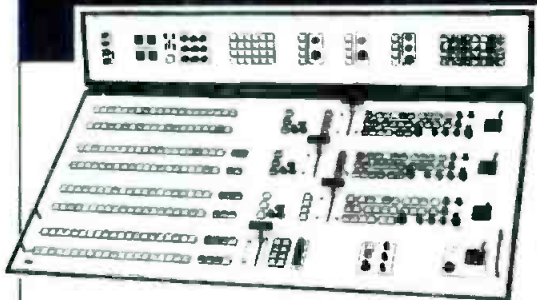

We're ISI
and quite
frankly we're
concerned

that you might be thinking about a 'big board' production switcher, without thinking of us. And that would be a shame. Because we've developed a common sense approach to production switching that gives you high powered performance at a surprising price.

Our 1200 series for example, has all the effects, patterns, and features you'd expect to find on a top of the line switcher. Plus some things no one else offers, or offers only as extra cost options. Like fade through black. Or tandem keying that allows you to do primary key (luminance or chroma) then add a second downstream key with outline, shadow, or border. All on a single, standard 1200 series Mix Effects System.

Look at our board. It gives you the creative flexibility to use more of the 1200's features—more of the time. Because it's simple and straightforward. No tricks or special combinations to remember.

Service? With our full two-year warranty, on sight test and check out, and toll free technical support number. We won't hang you up by letting you down.

So, if you're thinking about production switchers, remember this: by keeping it simple, we'll give you more! And cost you less! Now that's worth thinking about.

For complete specifications, and the name of your nearest authorized ISI Professional Video Products Distributor call:
800-874-7590 (Toll Free) 904-373-6783 (Florida Only)

Innovative Switching Ideas
from the people at:
INDUSTRIAL SCIENCES INC

P.O. BOX 1495
GAINESVILLE, FLORIDA 32602



Circle 135 on Reader Service Card

Rehab Tax Bonus

which items do and do not qualify for the investment credit.

For example, we've already mentioned that buildings and what Congress calls their "structural components" do not qualify. But where do you draw the line with those so-called "structural components"?

Under the newly clarified rules, the investment tax credit may be claimed for special lighting (including lighting to illuminate the exterior of a building but not lighting in parking areas). False balconies and other exterior ornamentation that have no more than an incidental relationship to the actual operation or maintenance of a building also qualify.

Identity symbols that identify or relate to a particular station such as materials attached to the exterior or interior of a building and signs (but not billboards) are now specifically eligible for the investment tax credit despite the Internal Revenue Service's earlier protests to the contrary.

Similarly, floor coverings which are not an integral part of the floor itself, such as floor tile installed in such a manner that it can be readily removed (that is, not cemented, mudded, or otherwise permanently affixed to the floor) qualify for the tax credit. In addition to those tiles applied with an adhesive designed to ease their removal, carpeting, wall panel inserts (such as those framing pictures of your advertisers' products), ornamental fixtures, artifacts, removable partitions as well as large and small pictures of scenery, persons, products, and the like which are attached to the walls or suspended from the ceiling all are exempted from classification as structural components and qualify for the credit under the new clarification.

You should beware of the principal drawback to claiming the investment tax credit, however. Whether investment credit property covered by the clarification or the newly added rehabilitation expenditures, you may be required to pay back or "recapture" that credit if you later dispose of the asset before the expiration of its originally estimated life.

For instance, if you reduce next year's tax bill by 10 percent of the \$3,000 you spent rehabilitating your studio after the passage of the new credit and dispose of the building during 1980 — you owe that entire \$300 to the IRS. Even worse, it will be added directly to 1980's tax bill rather than to taxable income.

Remember that those rehab expenditures must have a five-year life in order to qualify for the credit. Sale or other disposition before the end of the five-year period means the entire credit is "recaptured." Disposition of an asset with a life you originally estimated at seven years after only six years means repayment of one-third of the credit already used to reduce your tax bill.

When it comes to investment credit property other than rehab expenses, all of the credit is recaptured if an asset with a seven-year life is disposed of before three years; two-thirds of the credit is added to your tax bill if disposed of after three or four years and one-third recaptured if the actual life turns out to be only five or six years.

Despite this slight amount of risk — easily minimized with a little planning — the investment tax credit is now easier (and safer) than ever to use. And, for the first time, you may claim the tax credit for rehabilitating your studio.

BM/E

ALL NATURAL.

(for a healthy image.)

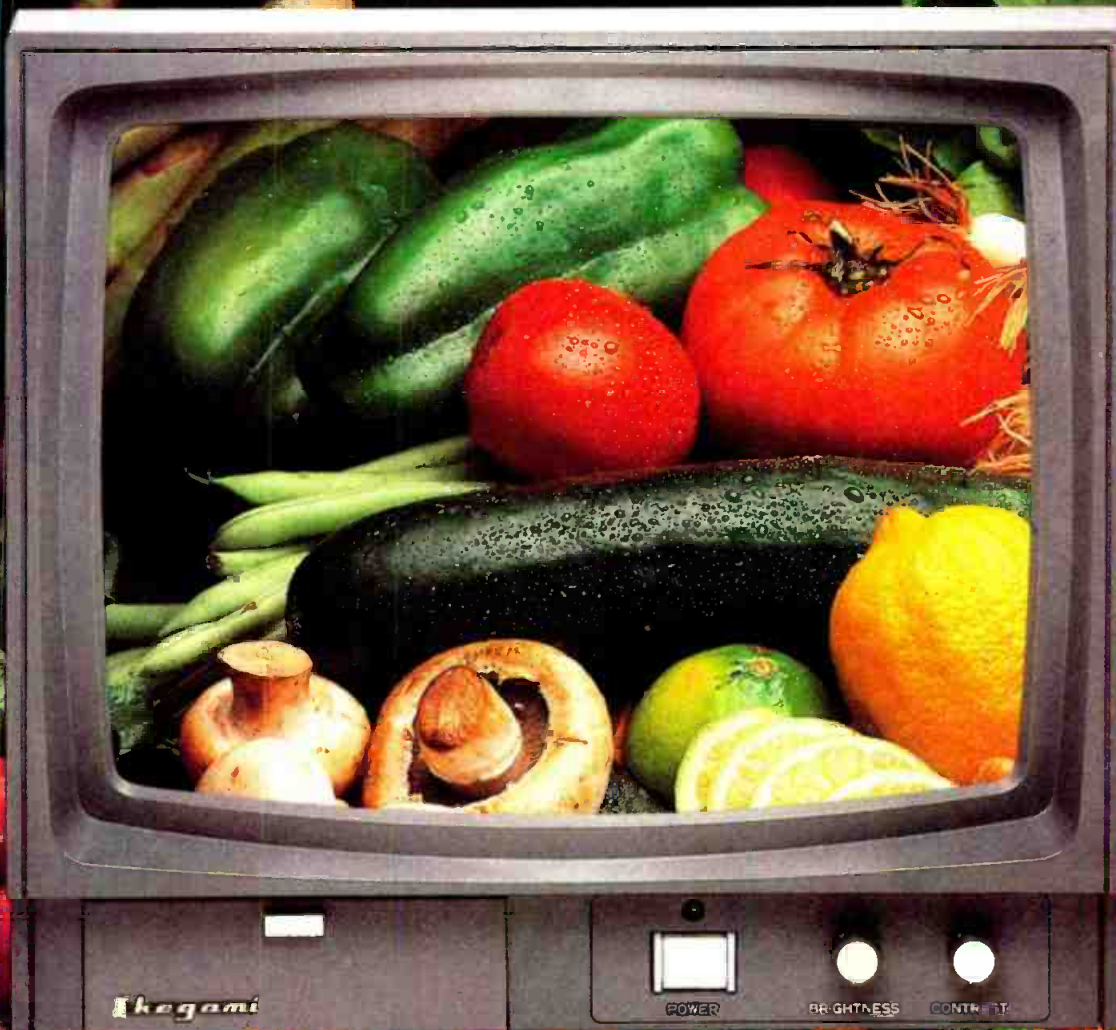

Take the purity, quality and precision of nature and incorporate it into a broadcast monitor capable of providing the most exacting picture imaginable, and you'll have created the "All Natural" Ikegami Broadcast Color Monitor.

All Natural because what you'll see is a picture in its purest form, down to the finest detail or defect.

Ikegami Broadcast Color Monitors maintain a healthy image.

It's why more and more engineers are specifying *Ikegami Broadcast Color Monitors*.

With features like our comb filter which results in resolution at 600 plus lines, shadow mask CRT's, power-protective circuits to avoid damage to the picture tube, an active convergence circuit, a phase lock system which eliminates horizontal hold control, sturdy construction, modular PC boards for simple servicing and maintenance, a

built-in degaussing circuit and magnetic shield to permit movement without affecting picture quality, and a wide range of models including 25, 20, 16, and 14 inch units (14 and 20 inch units offering standard and high resolution models), isn't it time you got into shape with Ikegami Broadcast Color Monitors?

For high-end, precision broadcast color monitors, it's Ikegami—naturally!

For details and additional information contact:
Ikegami Electronics (USA) Inc., 37 Brook Ave.,
Maywood, N.J. 07607, (201) 368-9174, West Coast:
19164 Van Ness Ave., Torrance, Calif. 90501,
(213) 326-2814, South West: 330 No. Belt East,
Suite 228, Houston, Texas 77060, (713) 445-0100.

Ikegami

Video Products Built To Ideal Standards

Available For Prompt Delivery

www.americanradiohistory.com



**THE \$10,000 SATICON®
THAT THINKS
IT'S A \$35,000 SATICON.**

When you're the world's first \$10,000* three tube saticon camera, it's hard not to get carried away.

But price alone isn't our only breakthrough.

The revolutionary XC-530 features remarkable reliability. Reliability that comes from our bias lighted three-tube bonded block design that eliminates mechanical registration adjustments. Which eliminates costly set-ups and down time—a problem common even to the most expensive cameras, especially after rough ENG/EFP assignments.

Sharp's new XC-530 can be externally driven or used with our gen lock option, allowing you to lock up to any existing system. The XC-530 accepts standard C-mount lenses, including our optional 10:1 auto iris power zoom lens.

Why else would you want a \$35,000 camera for \$10,000?

For its sensitivity, high S/N ratio, excellent colorimetry and low power consumption.

The only way you could possibly tell the difference between this saticon camera and one costing three times its price would be on electronic test equipment. And our new saticon studio camera, complete with CCU (Sharp's XC-500) delivers the same high quality as our portable model.

So take the Sharp challenge and see if the difference is worth the \$25,000 difference. We're betting it isn't.

For the name of the authorized Sharp dealer nearest you, turn the page.



SHARP'S XC-530 LIGHTWEIGHT PORTABLE CAMERA.



SHARP'S UNIQUE 3-TUBE BONDED BLOCK DESIGN.

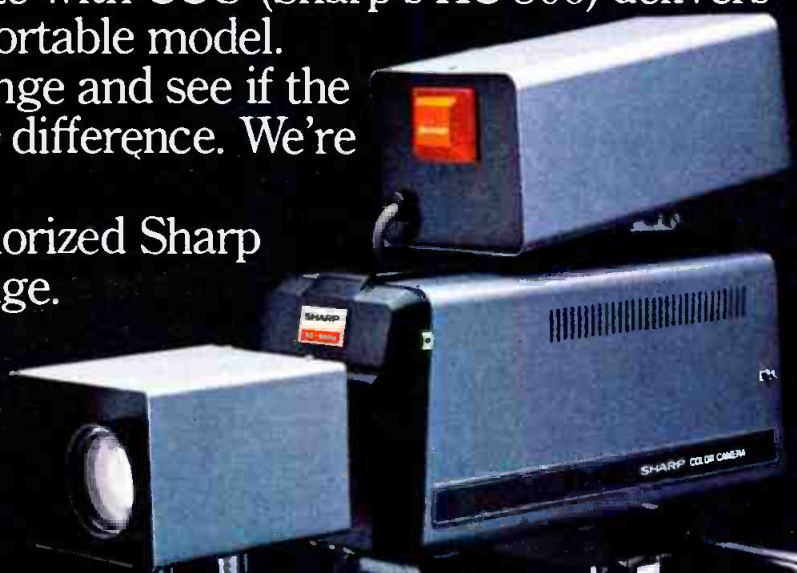

SHARP'S XC-530 STUDIO CAMERA IN REMOTE-CCU CONFIGURATION.

*Mfg. suggested list price, lens not included.
©Saticon is a registered trademark of NHK.

SEE THE \$10,000 SATICON THAT THINKS IT'S A \$35,000 SATICON.

Only these authorized Sharp dealers can show it to you.

Alabama

Signal Engineering & Sales, Inc.
720 South 23rd St.
P.O. Box 10167
Birmingham, AL 35202
(205) 328-6431

Alaska

Northern Video Systems
4600 Business Park Blvd.
Anchorage, AK 99503
(907) 279-5571

Arizona

Zonar Corp.
2922 W. Weldon
Phoenix, AZ 85017
(602) 261-2100

Arkansas

Fairview Audio Visual Co.
3520 W. 69th
Suite 102
Little Rock, AR 72209
(501) 568-7446

California

Video Media
250 North Wolfe Rd.
Sunnyvale, CA 94086
(408) 733-6500

The Video Store
7738 Clairemont Blvd.
San Diego, CA 92111
(714) 560-1154

Video Systems Network
12530 Beatrice St.
Los Angeles, CA 90066
(213) 871-0677

Pacific Video Product, Inc.
2600 E. Katella
Anaheim, CA 92806
(714) 634-8585

Connecticut

Concord Communications
970 High Ridge Road
Stamford, CT 06905
(203) 322-9322

District of Columbia

Midwest Telecommunications
1700 "G" Boston Way
Lanham, MD 20801
(301) 577-4903

Peirce Phelps
10215 Fernwood Rd.
Bethesda, MD 20034
(301) 530-9580

Florida

Midwest Telecommunications
3331 N.W. 82nd Ave.
Miami, FL 33122
(305) 592-5355 (Domestic)
(305) 592-3938 (Foreign)

Hawaii

Audio Visual Co.
875 Waimanu St.
Honolulu, HI 96813
(808) 533-3848

Illinois

Columbia Video Systems
1805 St. Johns Avenue
Highland Park, IL 60035
(312) 432-0725

Kansas

Nichols Electronics
6370 East Central Avenue
Wichita, KS 67208
(316) 686-2131

Kentucky

Midwest Telecommunications
1804 Cargo Court
Louisville, KY 40299
(502) 491-2888

Maine

Maine Video Systems
168 Forest Ave.
Portland, ME 04103
(207) 773-2355

Maryland

Midwest Telecommunications
1700 "G" Boston Way
Lanham, MD 20801
(301) 577-4903

Peirce Phelps
10215 Fernwood Rd.
Bethesda, MD 20034
(301) 530-9580

Massachusetts

Lake Systems
55 Chapel St.
Newton, MA 02160
(617) 244-6881

MP Video, Inc.
45 Kenneth St.
Newton, MA 02161
(617) 965-5405

Michigan

Thalner Electronics Lab
7235 Jackson Rd.
Ann Arbor, MI 48103
(313) 761-1506

Cruse Communications
4903 B Dawn Ave.
East Lansing, MI 48823
(517) 332-3579

Minnesota

VCI
7601 Washington Ave.
Minneapolis, MN 55435
(612) 941-6596

Missouri

Hoover Bros.
1511 Baltimore Ave.
Kansas City, MO 62116
(816) 221-7663

Radonics Electronics
1445 Gustine
St. Louis, MO 62116
(314) 481-2222

Central Missouri A/V
1000 W. Broadway
Columbia, MO 65201
(314) 874-2111

Business Communications
20 W. 9th St.
Kansas City, MO 64152
(816) 474-8000

Nebraska

Video Svcs. of Neb.
5900 Cornhusker Hwy.
Lincoln, NE 68507
(402) 466-6057

New Jersey

Modern Mass Media
315 Springfield Ave.
Summit, NJ 07901
(201) 277-6300

New Mexico

G.C. Video
Box 178
Ericson Road
Sandia Park, NM 87047
(505) 281-1303

New York

Camera Mart Inc.
456 W. 55th Street
New York, NY 10019
(212) 757-6977

Business Service Co.
131-135 No. Genesee St.
Utica, NY 13501
(315) 735-9296

Ashton Communications Systems
140 Glendale Drive
Endicott, NY 13760
(607) 748-3331

Audio Video Corp.
55 Delaware Ave.
Delmar, NY 12054
(518) 439-7611

North Carolina

Cooper D. Cass Co.
So. Stratford Rd. at Oak Dr.
P.O. Drawer 5059
Winston-Salem, NC 27103
(919) 722-8121

Technical Video Systems
245 Executive Park Blvd.
Winston-Salem, NC 27101
(919) 768-9536

Ohio

B & J Video Systems
525 N. Main St.
Findlay, OH 45840
(419) 424-0903

Midwest Telecommunications
1150C W. Eighth Street
Cincinnati, OH 45203
(513) 651-1904

Video Concepts
1450 E. 289th St.
Wickliffe, OH 44092
(216) 585-5453

Keyser Video, Inc.
2537 Wilmington Pike
Kettering, OH 45419
(513) 294-2786

Oklahoma

Fairview Audio Visual
4932 So. 83rd East Ave.
Tulsa, OK 74145
(918) 664-8020

Oregon

Videonics, Inc.
1112 SE Morrison
Portland, OR 97214
(503) 232-4632

Pennsylvania

Alpha Video
28 E. Mall Plaza
Carnegie, PA 15106
(412) 279-6169

Peirce Phelps, Inc.
2000 Block N. 59th St.
Philadelphia, PA 19131
(215) 879-7171

Sound Systems
6 Bysher Ave.
Flourtown, PA 19031
(215) 242-3500

D & H Distributing
2525 N. Seventh St.
Harrisburg, PA 17105
(717) 236-8001

Texas

Astro AV
1336 W. Clay
Houston, TX 77019
(713) 528-1662

Texas Video Systems, Inc.
10209 Plano Rd. #3
Dallas, TX 75238
(214) 341-1771

Texas Video Systems, Inc.
433 Breesport
San Antonio, TX 78216
(512) 341-1317

Martin, Zienkosky & Browne
13731 Omega Road
Dallas, TX 75240
(214) 233-5535

Utah

RIA Corp.
50 E. Malvern Ave.
Salt Lake City, UT 84115
(801) 486-8822

Virginia

Audio Fidelity
7217 W. Broad St.
Richmond, VA 23230
(804) 285-8781

Washington

Custom Video Systems
17521 15th Ave., NE
Seattle, WA 98155
(206) 365-5400

West Virginia

CRV Systems, Inc.
1901 Madison Ave.
Huntington, WV 25704
(304) 525-2633

Midwest Telecommunications
P.O. Box 385
Nitro, WV 25143
(304) 722-2921

Canada

Eastern:
Wackid Radio & TV Laboratories
312 Parkdale Ave.
Ottawa, Ontario K1Y 1G3
(613) 728-1821

Western:
Queale Electronics Ltd.
1004 North Park St.
Victoria, BC V8T 1C6
(604) 388-6111



Professional Products Department, Sharp Electronics Corporation, Headquarters Offices: 10 Keystone Place, Paramus, NJ 07652, (201) 265-5548; Western Regional Office: 1047 Carson Blvd., Torrance, CA 90502, (213) 830-4470.

TELEVISION DEMODULATOR PROOF-OF-PERFORMANCE

By John Price

With so many variables affecting off-air signals, a firm confidence in the demodulator is fundamental. Here are some recommended procedures for establishing the quality of performance provided by your demodulator.

Author's note: Since submission of the original manuscript, a new test generator (Tektronix TSG-6) has been obtained that simplifies procedures with the special test signal described in this paper. The new generator also provides an amplitude and phase-modulated multiburst which reduces somewhat the indicated bandwidth of that test signal. When using generators of this kind for demodulator calibration, it is still appropriate to employ the full line special test signal instead of multiburst.

ONE OF THE MOST perplexing problems facing television station operators is the accurate measurement of transmitted signals. Anyone charged with the duty of adjusting transmitters on the basis of observed waveforms will attest to that fact, after attempting to analyze the reasons for some fairly large differences in demodulator performance. Typically, these variances are non-trivial when comparing one demodulator with another. These uncertainties have been added to real discrepancies expected due to path differences in field measurements, differences as measured in each line of two-line antenna systems, or with the transmitter connected to a dummy load — but that is another story. Here we are concerned strictly with discrepancies attributable to the equipment used to make the measurements.

At KVO5-TV, it was decided to try calibrating the new Tektronix 1450 demodulators with what we felt were more direct methods than those usually employed. First, vast differences were noted between the 1450 demodulator video frequency response and that shown by the spectrum analyzer. Second, there were great differences in depth of modulation, using chopper reference in the various models of demodulators. We were curious to see which (if any) was correct.

It should be noted that the following procedures, developed for demodulator proof-of-performance, are universally applicable to various types and models of demodulators and test equipment.

Frequency response

The spectrum analyzer is a very broadband device and might reasonably be expected to provide a stable calibration reference for carrier and sideband energy. For the

John Price is chief engineer of Wometco subsidiary KVO5-TV, Bellingham, Wash., serving northwest Washington and British Columbia.

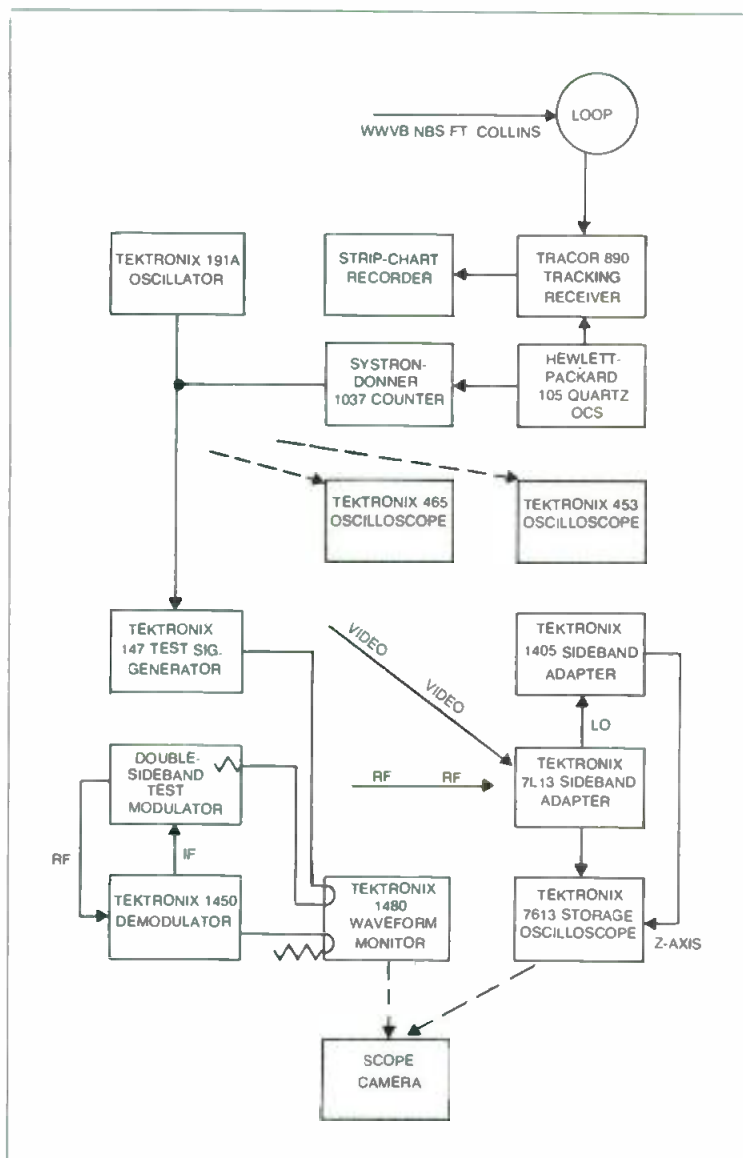

Figure 1. The block diagram shows the test setups used for the demodulator proof of performance

particular analyzer used in these tests, the station's Tektronix 7L13/7613, this was confirmed by calibration at the Tektronix factory where the response was measured to be within 0.2 dB across channels 11, 12, and 13. Lacking the means of confirmation in the field, we have been obliged

Proof-Of-Performance

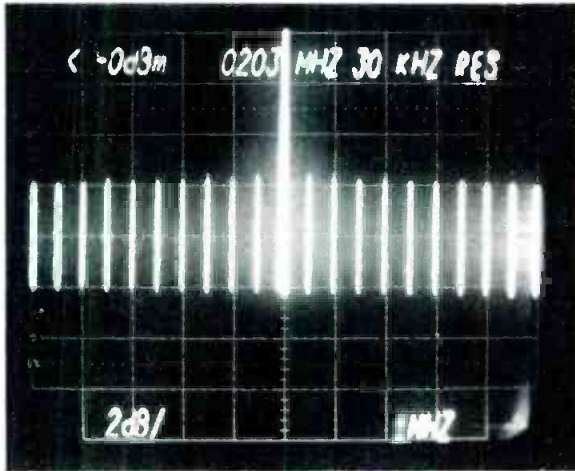

Figure 2. Spectrum display of channel 12 double-sideband modulator. Point-by-point: each 1/2 MHz to 5 MHz

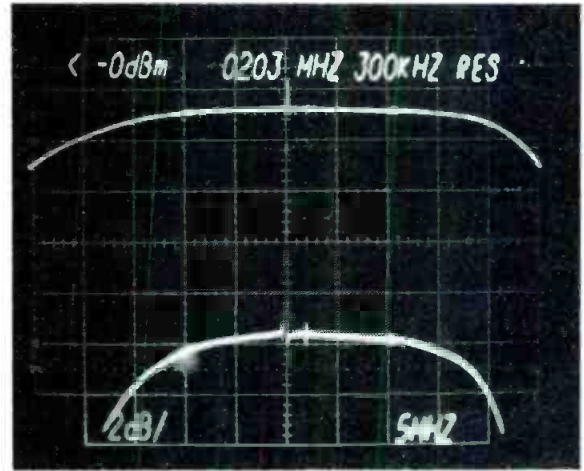

Figure 3. Spectrum display of channel 12 double-sideband modulator with video sweep (1405) 10 dB/div & 2 dB/div

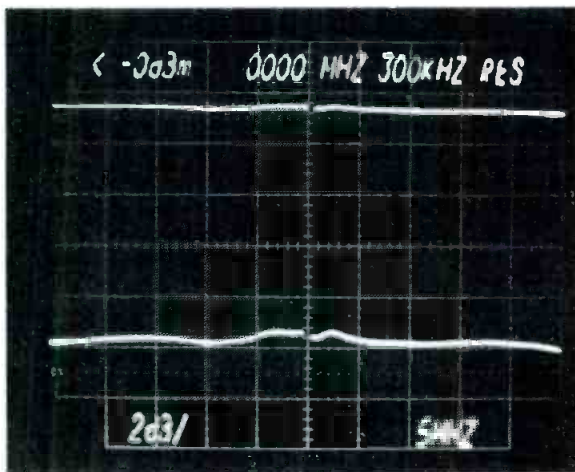

Figure 4. Spectrum display of video baseband (1405 sideband adapter)

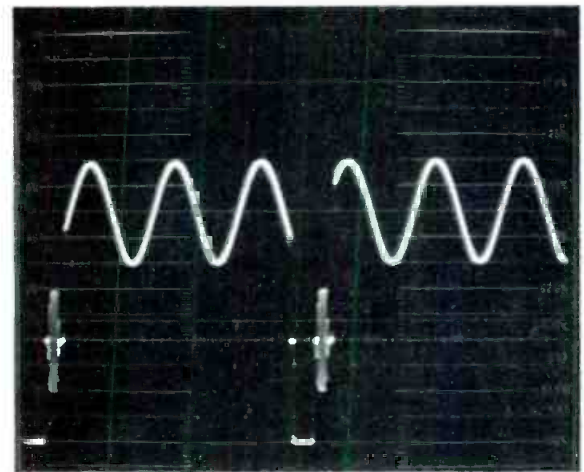

Figure 5. Special test signal full line/full field 50 kHz

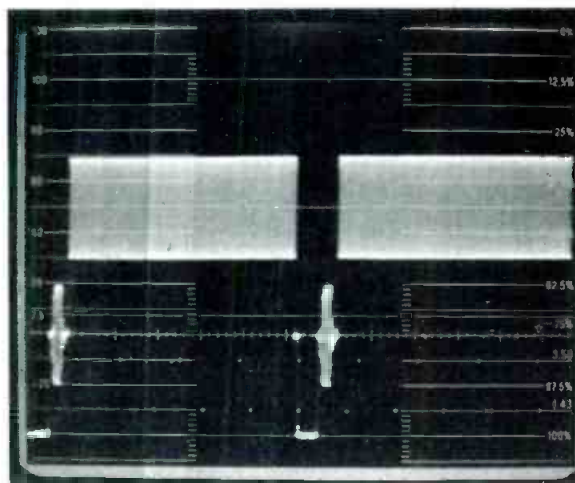

Figure 6. Special test signal. Full line/full field. 5 MHz

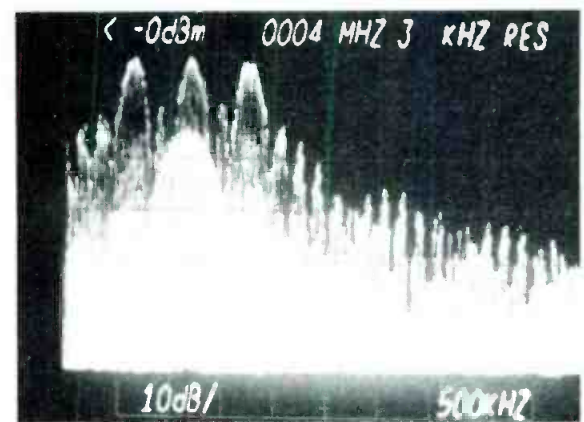

Figure 7. Multiburst baseband spectrum including the last three bursts (3.0, 3.6 & 4.1 MHz). Spurious above 4.1 MHz.

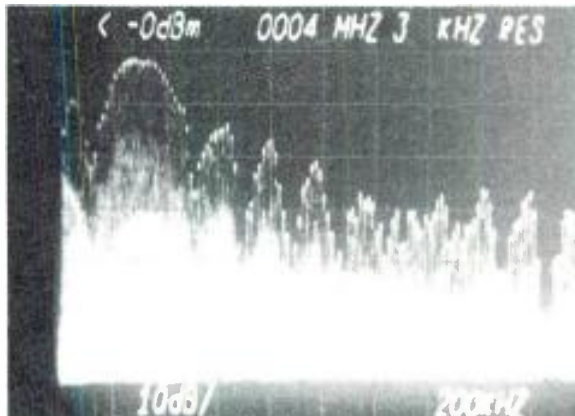

Figure 8. Multiburst as above 200 kHz/division

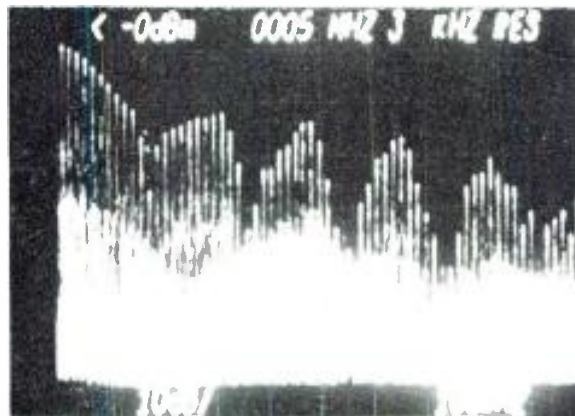

Figure 9. Multiburst as above 100 kHz/div

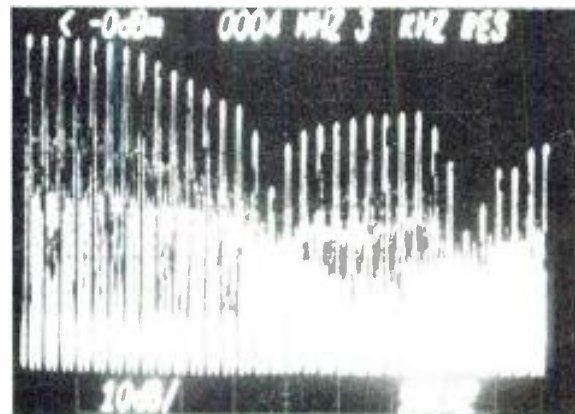

Figure 10. Multiburst as above 50 kHz/div

Figure 2 was made using the 7613 storage oscilloscope in single-sweep/store mode, 2 sec/div. A toggle switch was connected in the Z-axis circuit to allow manual blanking at the visual carrier on all except the final sweep. Base-line clipping was employed to further reduce blooming effects. Figures 3 and 4 used the 7613 in the same way, except that only two sweeps were made: one each for 2 dB/div, and 10 dB/div. Figures 11, 12 and 13 are purposely overexposed to show the faint but significant sidebands situated approximately 550 kHz each side of color subcarrier.

to accept this calibration, realizing of course that much depends upon the accuracy of these factory measures. We will assume that their signal generators have been calibrated to a very fine degree.

Figure 1 is a block diagram of the test setups. First, we need to compare the 191 oscillator/test modulator with the 7L13/7613 spectrum analyzer. Figure 2 shows upper and lower sideband voltages, as seen on the 7613, for modulation frequencies every 1/2 MHz between 1/2 and 5 MHz. The vertical scale is 2 dB per division, and the horizontal scale is 1 MHz per division. The 147 video output is also being monitored, using a 1480 waveform monitor and Model 465 and 453 wideband oscilloscopes. No deviation from flatness could be observed, indicating that the 1480 system will give an accurate measure of response to at least 5 MHz. Additional observations indicate this particular 1480 exhibits flat response to approximately 20 MHz with a gradual roll-off to approximately 40 MHz.

Figure 3 shows upper and lower sideband voltages (as seen on the 7613) for a modulation frequency continuum from zero to 25 MHz. Z-axis markers are shown at 10 MHz. Modulation is provided by a Model 1405 sideband adapter, which generates a video sweep signal, synchronized with the spectrum analyzer sweep. The upper trace is 10 dB/div, and the lower trace, 2 dB/div.

Figure 4 is the same 1405 video sweep at baseband (video frequency) with zero frequency at center screen and again two traces: 10 dB/div, and 2 dB/div.

It should be noted that the 1480 waveform monitor, when operated in FLAT position, will show an absolutely flat response as compared with the 465 and 453 over a very wide video range. Assuming performance is expected for the 7L13/7613, 465, and 453, this particular test modulator is essentially flat to beyond 6 MHz on the lower sideband and to beyond 12 MHz on the upper sideband. This gives a total range of 18 MHz over which it is not easy to discern variance from perfect response. One exception should be noted: a spur occurs at 2050 kHz above visual carrier. This creates a maximum rise of 0.8 dB at that point for measurements involving the spectrum analyzer. The USB response, however, is perfect at 1.9 and 2.2 MHz, so that for our purposes no significant testing error will result.

You may wonder why a special signal was needed for these tests (see Figures 5 and 6) rather than the standard multiburst, as specified in FCC Rules and Regulations, paragraphs 73.676(f) (1) (i) and 73.699, figure 13. Although at times multiburst can be of interest, its use as a quantitative probe is to be discouraged since the industry seeks better metrology. As an example of its shortcomings, note that the bursts are not all the same width, making direct comparisons in modern spectrum analyzers impractical. At 3.58 MHz there is roughly 5 dB difference between VIRS and burst, simply due to pulse width and shape differences, when a 300 kHz analyzer bandwidth is employed. Differences in analyzer multiburst levels will be somewhat less than 5 dB, but still highly significant.

The problem of meaningful comparison between short-duration phenomena at high frequencies with some low-frequency reference can now be solved as long as certain precautions are observed. It must be realized that the FCC test signals are all keyed or chopped at various repetition rates. Figures 7, 8, 9, and 10 illustrate the broad video spectrum analyzer display for a particular multiburst test generator. Spectrum displays for the other test signals are shown in Figures 11, 12, 13, and 14. This

SWITCHERS DON'T MAKE MISTAKES...PEOPLE DO

That's why we've designed a whole new series of human-engineered control panels that are setting new standards for goof-proof switching.

Once you've designed audio and video routing switcher matrices as transparent and reliable as ours, there's not much room for further improvement at that end. However, there has been a need for improvement in the control end--particularly where operators must make accurate, quick-decision source selections. The panels described below are designed to eliminate the confusion too often associated with routing switcher control, while providing the control flexibility so important to present-day signal routing requirements.

For installation simplicity, each of these new panels connects directly to the system party line via loop-through coax connections. They provide continuous status readout and can be encoded to permit each input (or output) to be addressed by its name (VTR-2, CAM-4, etc.) rather than by an arbitrary matrix number.

We are also prepared to supply custom variations of these panels to suit your exact requirements.

CSP-200

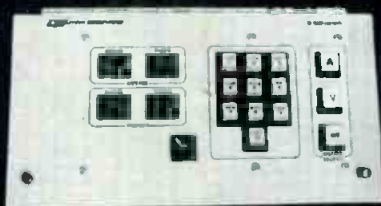

Permits audio and/or video selection--including simultaneous A/V switching from different sources--on a single output bus. Available in recessed mount, one unit per rack panel and two units per rack panel versions

CSP-300/R



Full Matrix Control Panel. Permits audio and/or video switching on any selected bus. Encoded version can be restricted to switch only on specific pre-assigned busses. Rackmount or recessed.

CSP-10



Controls and statuses ten busses (20 with Program Select switch installed). Provides separate audio and video switching and statusing.

CSP-20/CX-20

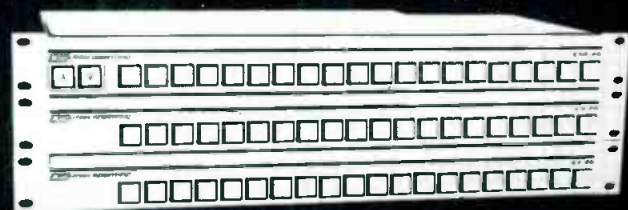

Permits button-per-source input selection on assigned bus. Basic panel accommodates 20 inputs. Expansion in 20-button increments is provided by adding CX-20 slave panels. Permits fast single-stroke selection of any input. Button lamps provide both audio and video status from refresh memory while *Only* buttons permit selective audio or video switching.

US UTAH SCIENTIFIC

2276 South 2700 West ■ Salt Lake City, Utah 84119 ■ Phone: 801-973-6840

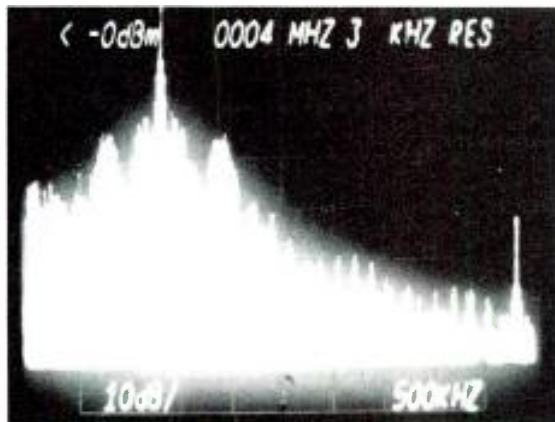

Figure 11. Linearity (modulated staircase) spectrum around color subcarriers

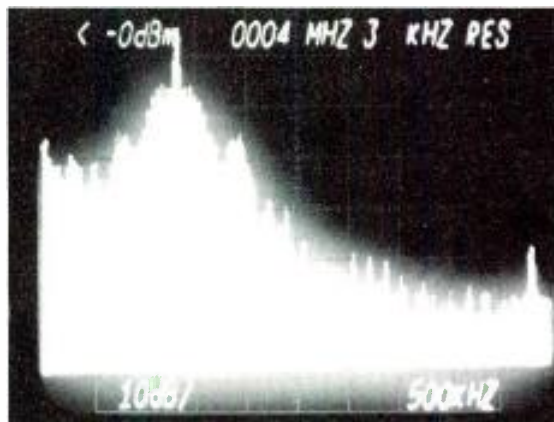

Figure 12. Composite test signal baseband spectrum around color subcarrier

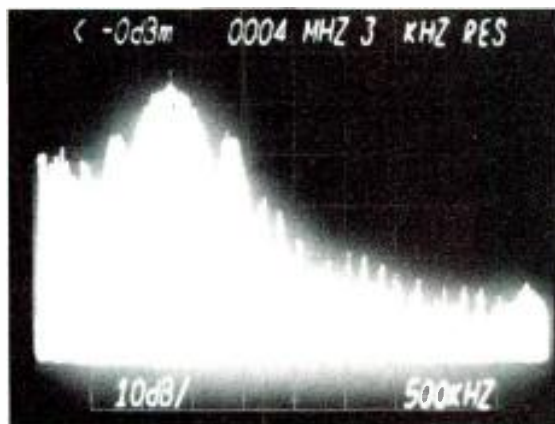

Figure 13. SIN²/Bar test signal baseband spectrum around color sc

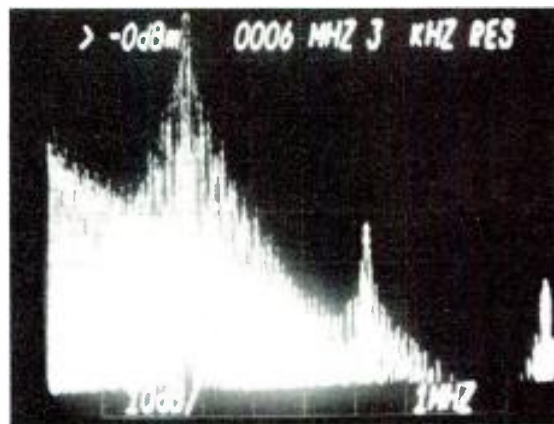

Figure 14. Color bars test signal baseband spectrum around color sc

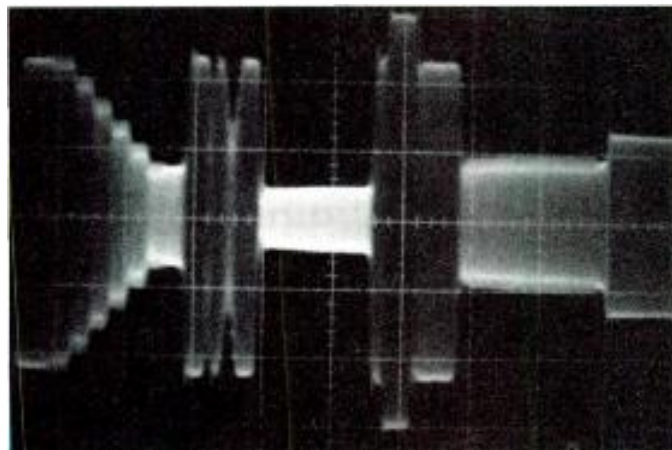

Figure 15. RF envelope of lines 18 & 19 as transmitted on channel 12. Modified Tektronix 7603

Author's note: Since submission of the original manuscript, a new test generator (Tektronix TSG-6) has been obtained that simplifies procedures with the special test signal described in this article. The new generator also provides an amplitude and phase-modulated multiburst which reduces somewhat the indicated bandwidth of that test signal. When using generators of this kind for demodulator calibration, it is still appropriate to employ the full line special test signal instead of multiburst.

modulation leads to receiver response that may indicate sideband energy extending far from each of the fundamental frequencies involved. This is a spectrum-broadening over and above that due to spectrum impurities (harmonics and spurious), which will be present to a greater or lesser degree in the various models of test generators. The way in which the bursts are keyed on and off will also determine to some extent how the recovered baseband will appear on the waveform monitor and on the spectrum analyzer. It is desirable to minimize spectrum broadening as much as possible. Particularly at the higher burst frequencies, 3.6 and 4.2 MHz, even a properly calibrated

demodulator will give an erroneous impression of system response if it is not in its broadband mode. Accordingly, measurements should be made with the sound trap switched OUT and only the visual transmitter feeding the dummy load.

Alternatively, if the demodulator sound trap or low-pass filter is left IN to eliminate aural interference, the demodulator will act as an upper vestigial sideband detector with results partially dependent upon the shape of the roll-off skirt as well as upon variations in test generator characteristics.

At first we thought the demodulator was somewhat

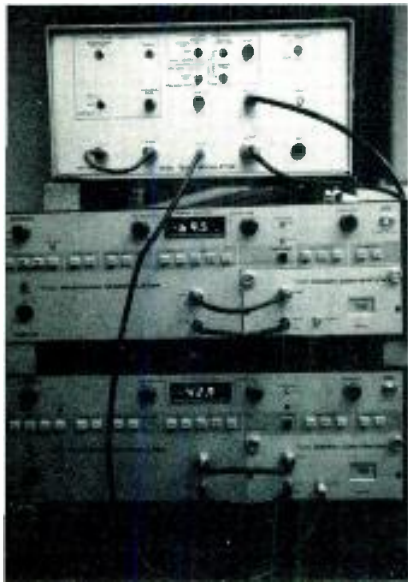

Figure 16. Double-sideband test modulator with Tektronix 1450 demodulators



Figure 17. Spectrum analyzer with video sweep generator



Figure 18. Video test generator (Tektronix 191) with frequency counter

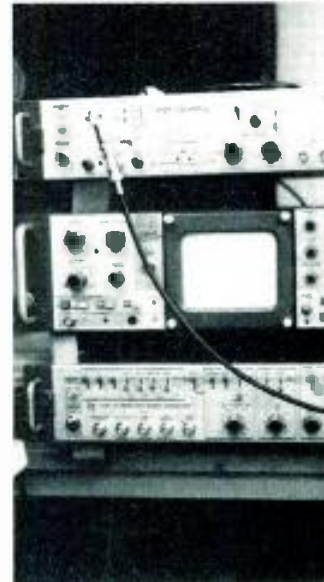

Figure 19. Test signal generators with Tektronix 1480 waveform monitor

rolled-off at 4.0 MHz (vis-a-vis the spectrum display). The error was improper interpretation of the recovered multiburst display. We have subsequently proved the 1450 narrow filter does not start down at least until after 3.95 MHz. Of course, a flat display with sound trap IN generally means the total system is peaked up on the high end. Exactly how much multiburst should appear to roll-off under these conditions must be determined experimentally in each TV plant.

From these considerations, the engineer can see some of the shortcomings of multiburst as a test signal. We need to be very careful in conclusions drawn from imperfect data.

The test modulator output cable is 50-ohm with N fittings. The receiving end of this cable has been loaded with a Narda 757C 6 dB 50-ohm attenuator for the purpose of swamping possible slight reflections in the line. However, results were the same with or without the attenuator, so in this case the added precaution proved to be unnecessary.

Depth of modulation

A modern version of the old DuMont 5034 waveform monitor has recently been developed at the KVOS-TV transmitter plant. The 5034 was a very simple device: modulated RF was brought directly to the vertical plates of a CRT through a balun. We have often thought there could not be much argument about results from this direct method of modulation measurement. The new version makes use of the excellent horizontal system in the Tektronix 7603 oscilloscope so that any individual line can be examined for modulation depth. Both 1450 demodulators show the identical modulation percentage, and both are

confirmed exactly by the direct method utilizing the modified 7603. A beautiful RF envelope display of linearity, \sin^2 , white flag, horizontal sync and blanking, and VIR signals as shown is Figure 15.

Conclusion

Satisfactory proof-of-performance has been made for a new TV demodulator. Two of the performance tests — for frequency response and depth of modulation — have been described in this article. Although other details of demodulator operation have been investigated, these two are perhaps the most difficult to prove.

In those cases where the demodulator recovers audio in two ways — intercarrier and split carrier — a good audio system with sufficient gain and limiting can give much information about visual transmitter phase stability throughout the modulation range. Similar information can be gained from a demodulator that recovers video in two ways — envelope and synchronous detection.

The new demodulators may also be capable of providing the stability in recovered video baseband necessary to consider very accurate measurements of envelope delay. The requirement has been implied for years in FCC Rules and Regulations, Paragraph 73.687(a) (5), but accurate measurement of envelope delay from 50 kHz to 4.2 MHz generally has required a compromise split-frequency (20 kHz) swept across baseband by fairly expensive test sets. The $12\frac{1}{2}$ T pulse gives a delay comparison between two important bands of frequencies, but cannot suffice for the system proof-of-performance. We look forward to the possibility of software application to this problem using modern demodulators and electronic data processing.

BM/E

Marconi Television Interval Timer Model 2920 measures the following parameters

MARCONI has the proven answer to 'H' & 'V' Blanking Measurements

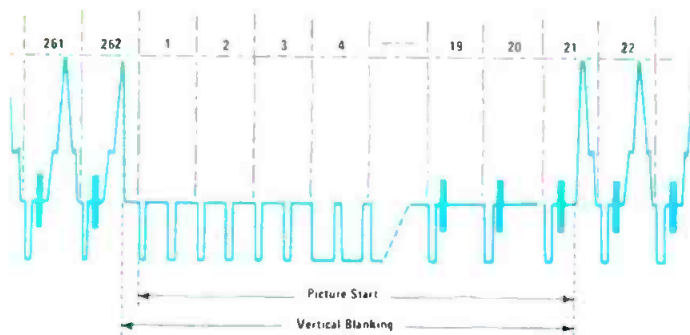

VERTICAL BLANKING MEASUREMENTS

Total Vertical Blanking Interval
Picture Start
Equalizing Pulse Width
Serration Width

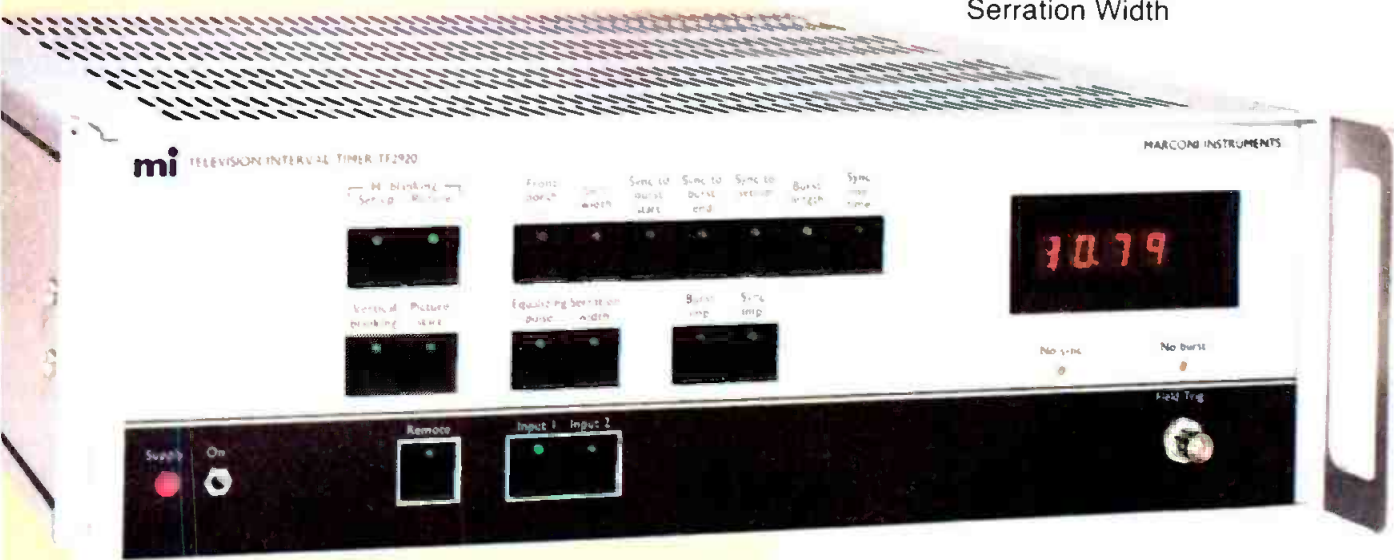

See How Easily Timing Measurements Can Now Be Made

- Fast accurate measurements at the touch of a button
- Results from samples taken throughout active field
- Blanking at set-up (+4 IRE) and picture (+20 IRE) measured independently to 10 nsec. resolution
- Vertical Blanking resolved to 1/10 line
- Printout from BCD output on command
- All functions may be remotely controlled for simple system integration
- Manufactured in U.S.A., domestic price \$4950

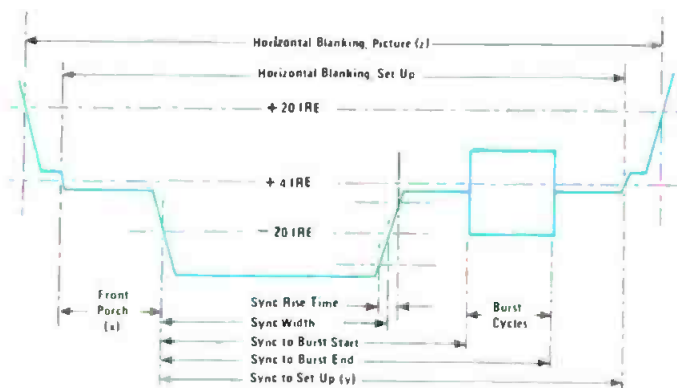

HORIZONTAL BLANKING MEASUREMENTS

Set Up Blanking (+4 IRE)
Picture Blanking (+20 IRE), (z)
Front Porch, (x)
Sync Width
Sync to Burst Start
Sync to Burst End
Sync to Set-Up, (y)
Burst Length in cycles
Sync Rise Time

REFERENCE MEASUREMENTS

Burst Amplitude in IRE
Sync Amplitude in IRE

marconi instruments

100 STONEHURST COURT, NORTHVALE, NEW JERSEY 07647
TELEPHONE: (201) 767-7520 • TWX: 710-991-9752

Circle 139 on Reader Service Card

How can we convince is really a total

Perhaps we should begin by telling you that the Arvin-Echo Slo/Mo-1 is one of the best investments you can make.

It's a great investment because it will allow your staff to offer production techniques that add up to increased business. And increased business means Slo/Mo-1 will pay for itself in a short period of time!

Regardless of your activities—Sports, News, or Commercials—Slo/Mo-1 can make a big difference.

A difference like Animation! Imagine being able to incorporate Animation from any source into your productions!



If that's not enough, let's add the fact that Slo/Mo-1 uses our unique Discassette[®] rather than a hard disc or 1" tape. Because it is a disc, it operates equally well in either forward or reverse. And that means even the most difficult editing job can be greatly simplified!

So add complete editing to Slo/Mo and Animation!

We don't call Slo/Mo-1 a production tool without good reason!

We set out to design the best Slo/Mo possible. And we built in the features that will make your productions stand out from the competition!

Features like *Field/Frame Select*, *Time Lapse Recording*, *Digital Comb Filter*, *High Band Color*. And configured to be so *small, rugged, and portable* that two men can easily transport it to almost any location. Plus Slo/Mo-1



Don't get wrapped up with 1!"

you that our Slo/Mo-1™ production tool?

is *expandable* to meet your system requirements!

So how can we convince you?

In addition to owning one of the best Slo/Mo's on the market, you'll be able to provide services, either in your studio or on location, that will make you Number One with viewers and customers.

Yet, now that we think about it, there's really only one way to convince you.

Give us a call today for a complete, no obligation demonstration and quotation on a lease or buy program!



ask for the Disc Marketing Team

ARVIN/ECHO™

ECHO SCIENCE CORPORATION
an ARVIN company

485 E. Middlefield Road
Mountain View, California 94043

Tel: (415) 961-7145 TWX: 910-379-6499

Circle 140 on Reader Service Card

MICROTIME

For Video Processing



- 1 2525 Video Signal Synchronizer
- 2 2100 Video Image Processor
- 3 1600 Time Base Corrector
- 4 Digitrol 2 Video Source Control System
- 5 2020 Video Signal Processor

Microtime offers an entire range of video products for advanced Time Base Correction, Image Processing, Remote or Local Synchronizing, and Automated Programming for the Best pictures possible.

2525 Video Signal Synchronizer

Synchronizes any video source, 3/4" heterodyne, 2" quad, satellite feeds, to station sync. Provides field 1, field 2 or frame freeze for digital video effects. Auto freeze on last field of active video. Infinite H phase resolution and RS-170A Sync Generator for interfacing with any switcher.

2100 Video Image Processor

Provides 6dB video noise reduction in luminance and chrominance, horizontal and vertical detail improvement, chroma crispening and chroma hue error reduction. Automatic Chroma/Luminance delay compensation corrects chroma smear inherent in most heterodyne VTRs. Improves the overall picture quality of any video picture.

1600 CCD Time Base Corrector

The Standalone TBC uses charge-coupled device technology to provide high performance at low cost. 55 dB Signal-to-Noise Ratio, 4 H line correction range, Auto Trac 2 and automatic sync advance are standard.

Digitrol 2 Video Source Control System

Highly versatile automated programmer for use in studio applications, CATV automation, video tape duplication, automatic commercial insertion, editing control, and off-air recording and delay applications.

2020 Video Signal Processor

Time base corrects any video source using digital technology. 58 dB Signal-to-Noise Ratio, 4 H line correction range, Auto Trac 2 and automatic sync advance are standard. Line Error Detection, Velocity Correction, 24 H line Wide Window correction range, Dropout Compensation, Image Processing and Noise Reduction Options are available to fit your particular needs.

All Microtime products are available and supported through our worldwide distribution network.

Call today for the name of the distributor nearest you.

Microtime, Inc.
1280 Blue Hills Avenue, Bloomfield, CT 06002 Telephone (203) 242-0761 TWX 710-425-1165
Microtime International
Rokin 9-15 Amsterdam, Holland 1012K Telex (844) 16354

THE SOURCE

THE VERIFIED BUYER'S GUIDE

WELCOME TO THE SOURCE, 1979. This year's buyer's guide, compiled by *BM/E*, provides you with the most current list of manufacturers and independent representatives and distributors serving the broadcast industry. The Source is designed to be a useful everyday guide to the most important products and services required by the broadcaster to stay on-the-air.

Everything has been done to assure the reader that the companies listed are reliable sources of products and services. The companies whose listings incorporate a VS symbol are "Verified Sources." The VS designation means that the company has supplied *BM/E* with information indicating that the products claimed by the company are regularly available to broadcasters. This supporting information is on file with *BM/E*.

The Source is divided into three sections: the Instant Source Locator, an alphabetical listing of suppliers, and a listing by state of independent reps/distributors. The Instant Source Locator (beginning on page 74) is designed to help you find manufacturers of particular products. Ten major product categories have been noted and indexed. Each of the 10 product categories has been further subdivided into classes of products and then broken out into specific product types. For instance, Category I, Audio Equipment, has as its first subcategory Audio Amplifiers. Audio Amplifiers are further divided into eight specific types of amplifiers.

Here's how to use The Source: first, identify the product you seek by its general category (i.e. video or audio). Then after you find its general category look for the specific heading that applies and finally for the specific

type of product you need. If, for instance you were looking for a wireless microphone, you would first turn to the Audio section, look for the microphone heading, and then look for the "wireless microphone" listing. You would find that wireless microphones in the microphone section are number 4. Look across to the list of companies and note each company name accompanied by the number 4. This should give you a complete list of companies manufacturing this product. Then turn to the alphabetical listing of Broadcast Equipment Manufacturers (beginning on page 89) and you will find these companies along with their addresses, telephone numbers, descriptions of their entire product line, and possibly references to the rep/dist list. If a reference to the rep/dist list is provided, you may find the nearest source of the product by turning to the listing of Independent Broadcast Reps and Distributors (beginning on page 161) for your state. By scanning this list for a boldfaced cross reference to the manufacturer's name, you should find a local source.

Another useful reference you may find will be the red listings provided to advertisers. Below the advertiser's listing will be a reference to the page on which its ad appears. Consulting the ad will often provide you with details on the product you seek or on the company you wish to contact.

Remember, the VS in the alphabetical listing or the ▼ in the Instant Source Locator is our way of assuring you that we have information indicating that the products you are looking for are normally available from the manufacturers so designated.

INSTANT SOURCE LOCATOR.....	74
MANUFACTURERS.....	89
INDEPENDENT REPS/DISTRIBUTORS...	161

INSTANT SOURCE LOCATOR

I. Audio Equipment	68
II. Video Equipment	73
III. Film Equipment	76
IV. Lighting/Studio Equipment/Set Design	78
V. RF/Transmitting/Receiving Equipment	78
VI. Antennas/Towers/Transmission Lines	80
VII. Measuring/Monitoring/Timing/Logging Equipment	80
VIII. Services	84
IX. Components/Hardware	84
X. Systems	84

I. AUDIO EQUIPMENT

Audio Amplifiers

1. distribution
2. line
3. pre-amps
4. op-amp modules
5. monitor
6. power
7. public address
8. amplifier power supplies

Acoustic Research 5▼; Ailtech 6▼; Aitken 5▼; Allied Broadcast 1,3▼; Altech Lansing 1-3,5-7▼; American Data 1,2,5▼; Ashly 3▼; Audio & Design Recording 1,3▼; Audiotechniques 5-7; Audionics Oregon 1,3-6; Audiotechniques 5-7; Audio Technology 3; Autogram; Automated Processes 1-6,8▼; Bayly 1-3,5,6▼; Bell Audio 1,3,6,7▼; BGW Systems 5-7▼; Bonneville 1,2▼; Boston Sound 1-4,6; Bozak 3,5-7; Broadcast Elect. 1-3,5-8▼; CCA 5▼; Channelmatic 1; Collins-Rockwell 3▼; Crown 3,6; Datatek 1▼; Delta 8▼; Delta (Long) 1-3,5; Di-tech 1,5▼; Dunlap-Clarke 3,5-7▼; Dyma 1-3,5,6▼; Dynair 1,3▼; Dynasciences 1▼; Edco 1▼; Edcor 1-3,6,7; EMS 5▼; Fisher Berkeley 7,8; Frequency Devices 8; Hammond 6; Harris 2,3,5,6,8▼; Holland 2-6; Industrial Sciences 1,3▼; Intl. Nuclear 1-3,5▼; ITI 2,3,5,6,8▼; Ivie 3,6,7▼; JBL 2,3,5-7▼; J&D 1,5; Johnson Elect 1,3,6,7; Lauderdale 1,3; Lear Siegler 1-3,5-8; Logitek 1,5,6▼; LPB 1▼; Marti 2,5,6▼; McCurdy 1,3,5,6▼; McMartin 3,5-7▼; Memorex 3▼; Micro-Trak 1,3▼; Modular Audio 1-5,8▼; Nat'l Electrolab 6; Neff 1-3,5,8; Rupert Neve 1-3▼; Nikko 3,6▼; Opamp 1-6,8▼; Orange County 5▼; Pacific Recorders 1-3▼; Panasonic 3,6▼; Pro Tech 1-8▼; QRK 1,2,5▼; Quad-Eight 2,3,6▼; Ramko 1-3,5▼; RCA 1,3,5,8▼; ROH 1-3,5-8▼; RTS 1,3▼; Russco 1,3,5,6▼; SAE 6▼; Sansui 3,6; Scientific Radio 6; Scientific Systems 1; Sescom 2-4,6,8▼; Sharepoint 1-3,7▼; Sharp 6▼; Shintron 1; Shure 3,7▼; Sigma 1; Sontec 1-4; Spectra Sonics 1-3,5-8▼; Stanton 3▼; Studer Revox 6,8▼; Tandberg 5▼; Tapco 6▼; T.A. 3▼; Technics 3,6▼; Telectro 7; TeleMation 1,5,6,8▼; Telemet 1,5▼; Telex 3,6▼; Thomson-CSF 1▼; TM 2,8; Transist-O-Sound▼; Tweed 1,6▼; Ultra Audio▼; Uni-Sync 6▼; United Research 4▼; UREI 2,3,8▼; Varian 3,6▼; Versa-Count 1▼; Video Aids 1,8▼; VIF 4▼; Vital 1▼; Wilkinson 1,2; Yamaha 5-7▼

Audio Controls

1. rotary attenuators
2. slide attenuators
3. switchers

American Data 3▼; Audio Designs 2▼; Audionics 2▼; Automated Processes 2,3▼; Channelmatic 3; Duncan 2▼; Dynair 3▼; IGM 3▼; ITI 9▼; Kay Elemetrics 1,2; Rupert Neve 2,3▼; Oak 3; Opamp 2▼; Pacific Recorders 3▼; ProTech 2,3▼; Quad-Eight▼; Ramko 3▼; ROH 1-3▼; Shallco 1▼; Spectra Sonics 2▼; Superex 3▼; Switchcraft 3▼; Tech Labs 1,2▼; TeleMation 3▼; Telemet 3▼; Utah Scientific 3▼; Vamco 1; Ward Beck 3▼; Waters 1,2

Audio Processing Equipment

1. ALC and AGC amplifiers
2. compressors/limiters, AM
3. compressor/limiters/filters, FM
4. equalizers and filters—passive
5. equalizers and filters—active
6. special effects
7. reverb units
8. delay lines
9. stereo phase enhancer

Advent 8; Aitken 5▼; AKG 7▼; Allison 2,3; Altec Lansing 1,4,5,8▼; Ampex 8▼; AP Circuit 5; Ashly 1-3,5▼; Audio & Design Recording 1-3,5,6,8▼; Audio Designs 5▼; Audio Processing Systems 5▼; Audiotechniques 4,5; Automated Processes 4-6▼; Bayly 4▼; BEI 5; Bozak 4,8; Broadcast Elect. 1-3▼; Caringella 2,3; CCA 1-3▼; Coastcom 2-5▼; Coherent Comm. 1-6▼; Comrex 5,8▼; Crown 5; dbx 1-3,5▼; Delta 1,2▼; Dolby 3▼; Dorrough 2,3▼; Dyma 1-3,5-7▼; Edco 9▼; Elcom 1-3▼; EMS 2▼; ESC 8▼; Eventide 2,3,6-9▼; Frequency Devices 5; Gotham Audio 2,3,5,7,8▼; Gregg 2,3,5▼; Harris 1-5▼; Harrison 5; Inovonics 1-3▼; Intl. Electro-Magnetics 5▼; Ionic 6; IT14▼; Ivie 5▼; JBL 2,3▼; Lexicon 6-8; Kahn 4; Kappa 8; Lauderdale 1-5,7; Lear Siegler 1-5; LPB 2,3▼; Marti 1-3▼; McCurdy 1,5▼; MCI 9▼; McMartin 1,3▼; Micmix 6,7▼; Modular Audio 2,5▼; Moseley 1-3▼; MXR 5,6,8▼; Neff 8; Rupert Neve 4-6▼; Nikko 2▼; Opamp 1,5,7▼; Orange County 1-6▼; Orban 2-7▼; Pacific Recorders 2,3▼; ProTech 1,4,5,7▼; Pulse Techniques 4▼; QEI 1,2▼; QRK 7▼; Quad-Eight 2-5,7,8▼; Quantum 7▼; Ramko 1,4,5▼; RCA 1-3,5▼; Rockland 5; SAE 5▼; Sansui 7; Ken Schaffer 6,7,8▼; Sescom 1,5▼; Shure 1,3,5▼; Sontec 2,3,5; Spectra Sonics 2,5▼; Tapco 5,7▼; T.A. 1,2,6▼; Technics 4,5▼; Thompson-CSF 1-3,5▼; Transist-O-Sound 1▼; TT 3▼; Tweed 2,3▼; UREI 2,3,5,8▼; Variable Speech 6,8▼; VIF 5,7▼; Wang 6,8▼; White 4,5▼; Wilkinson 1-3; Yamaha 5,6,8▼

Automation Equipment

1. sequencers, relay
2. sequencers, time insertion
3. computer/microprocessor controllers
4. memory units
5. reel decks
6. multi-cart machines
7. read out/display
8. data input devices
9. auto loggers
10. tone generators
11. auto time/weather announcers
12. complete systems

Ailtech 10▼; Aitken 2,4,12▼; Allison 3; Altec Lansing 10▼; Audio Processing Systems 4,7▼; Autogram; Automated Broadcast Controls 1-4,6,9-12▼; AVL Digital 3,12▼; Boston Sound 3,4,8; Broadcast Elect. 1-12▼; BTX 3,7▼; Central Dynamics 3,10,12▼; Cetec 1-12▼; Channelmatic 3; Computer Business Systems 2-4,7,8; Consolidated Elect. Ind. 3,5-8, 12▼; Di-tech 10▼; Dyma 3▼; Elcom 10▼; Eventide 3▼; Hallikainen 9,11▼; Harris 1-12▼; Harrison 3; IGM 1-4,6-12▼; Inovonics▼; Intl. Nuclear 10▼; Intl. Tapetronics 5,6▼; Microprobe 1,12▼; Nationwide 1-4,9,12; Otari 5▼; PWH 1-4,7-9; Sharepoint 3,4,7-9,12▼; Sono-Mag 2-6,9-12▼; Tape-Athon 5; Tapecaster; TeleMation 2,3,11,12▼; Telex 1,2,5,6,9▼; Time & Frequency 3,8,9▼; UMC 1,3,6,12▼; Video Specialties 3▼

▼ MEANS VERIFIED SOURCE

Consoles
 1. mixers
 2. mono
 3. stereo
 4. quad
 5. audio for TV
 6. portable

Altec Lansing 1-4.6▼; Ampro Scully 1-3▼; Audio Designs 2-6▼; Audiotechniques 1; Audiotronics 1-6▼; Autogram 2.3; Automated Processes 1-5▼; Bayly 6▼; Boston Sound 1; Broadcast Audio 1-3.5.6▼; Broadcast Elect. 1-6▼; BSM 6▼; CCA 2.3.5▼; Cetec 1-6▼; Coherent Comm 1-6▼; Collins-Rockwell 1-3▼; Custom Audio 1.3.6▼; Dage/MTI 2▼; Delta (Long) 1-6; Dyma 1-6▼; Hallikainen 1.2.5▼; Hammond 3; Harris 1-3.5▼; Harrison 1-4; HME 1▼; Holland 1.4.5; Howe 1▼; Image Devices 6▼; Industrial Sciences 1.3▼; Intl. Nuclear 1.2.5.6▼; Listec 5.6▼; Logitek 2.3.5▼; Long; LPB 1.2.5▼; Magna-Tech 1; Marconi 1.5.6▼; McCurdy 1-3▼; MCI 1-4▼; McMartin 1-3.5.6▼; Modular Audio 2.3.5▼; Moseley 6▼; Nagra 6▼; Rupert Neve 1.3-6▼; Nikko 2-4; Pacific Recorders 1-3.5▼; ProTech 1-6▼; QRK 1-3.5.6▼; Quad-Eight▼; Quantum 1-3.5▼; Ramko 1-6▼; RCA 1-6▼; Richmond Sound; RTS 1▼; Russco 1-3▼; Son-tec 1.6; Spectra Sonics 1-5▼; Sphere 1; Studer Revox 1.3.6▼; Switchcraft 1▼; Tapco 1-3▼; T.A. 1.3.6▼; Teac 1-3▼; Theatre Techniques 1▼; Transist-O-Sound 6▼; Tweed 1-6▼; 2005AD; Ultra Audio▼; UMC 1.3.5▼; Uni-Sync 1-3▼; UREI 2-5▼; Video Aids 5▼; Ward Beck 1-5▼; Wilkinson; Yamaha 1.3-6▼

Disc Playing Equipment
 1. turntables
 2. pickup arms
 3. pickups. stereo
 4. pickups. quad
 5. turntable pre-amps and controls
 6. complete disc consoles

AKG 3▼; Astatic 3; Audionics Oregon 5; Audio Technology 5; Audio-Technica 3▼; Audiotronics 3▼; Broadcast Elect. 1.5.6▼; Cetec 1-6▼; Dyma 6▼; Elpa 1; Gotham Audio 1.3▼; Harris 1.2.5▼; Lauderdale 5; LPB 1.2.5.6▼; McCurdy 1.5▼; Micro-Tak 1-3.5.6▼; Nikko 1▼; QRK 1.2.5.6▼; Ramko 1.5▼; RTS 5▼; Russco 1.2.5▼; Sansui 1; Sharp 1▼; Shure 1-5▼; Stanton 1-3.5▼; T.A. 5▼; Technics 1; UREI 5▼; Yamaha 1▼

Headphones

AKG▼; Audiosears▼; Audio-Technica▼; Audiotronics▼; Burns Audiotronics▼; David Clark▼; Holland; Image Devices▼; Koss▼; Nakamichi▼; R-Columbia; Setcom▼; Stanton▼; Superex▼; TEA▼; Telex▼; US Pioneer▼; Yamaha▼

Intercom Systems

Altec Lansing▼; American Microsignal; Automated Processes▼; Bayly▼; Clear Com▼; Comrex▼; Crosspoint Latch▼; Custom Audio▼; David Clark▼; Dyma▼; Fisher Berkeley▼; Heath; Holland; IGM▼; Image Devices▼; Lear Siegler; Long; Marconi▼; McCurdy▼; Nova; RCA▼; R-Columbia; Rivers; ROH▼; RTS▼; Ken Schaffer▼; Setcom▼; Sharepoint▼; TEA▼; Telex▼; Theatre Techniques▼; Video Aids▼; Ward Beck▼; World Video▼

Microphones
 1. dynamic
 2. condenser
 3. ribbon
 4. wireless
 5. shotgun
 6. lavalier
 7. booms and dollies
 8. accessories

Accurate Sound 7▼; AKG 1.2.5-8▼; Altec Lansing 1.2.6▼; Astatic; Atlas 7.8▼; Audiosears 1▼; Audio-Technica 1.2▼; Audiotechniques 7; Audiotronics 1.2.6▼; B&K 2▼; Burns Audiotronics 1-4.7.8▼; Coherent Comm. 2.4.6.8▼; Comrex 4▼; Dyma 1▼; Edcor 2.4.6; Electro-Voice 1.2.5-8▼; Alan Gordon 4.7.8▼; Gotham Audio 2.5-8▼; HME 1.2.4.6▼; Image Devices 2.6▼; Marti 1.4▼; Microtran 8▼; Nagra 6▼; Nakamichi 1.2.5.8▼; R-Columbia 1.2; Redding 8▼; Ken Schaffer 4▼; Sennheiser 1.2.4-8▼; Sescor 7.8▼; Shure 1-3.6.8▼; Studer Revox 2▼; Superscope 2▼; Superex 2.8▼; TEA 1▼; Teac; Technics▼; Television Products 7▼; US Pioneer 1.2▼; Vega 4▼

Music Synthesizers

ARP; Electronic Music; Ionic; Moog▼; Ken Schaffer▼; Yamaha▼

Noise Reduction Systems

Audio & Design Recording▼; Audio Designs▼; dbx▼; Dolby▼; Eventide▼; Frequency Devices; Gotham Audio▼; Nakamichi▼; Orange County▼; Quad-Eight▼; SAE▼; Thomson-CSF▼

Patch Panels, Audio Connectors

Altec Lansing▼; Atlas; Audio Accessories▼; Audio Designs▼; Bayly▼; Dyma▼; Innovonics▼; Kings Electronics▼; Lauderdale; McCurdy▼; QRK▼; Switchcraft▼; VIF▼; Wide-Band▼

Quad Matrix Equipment Audionics Oregon 2; CBS Technology▼; Sansui
 1. encoder 1
 2. decoder

Speakers

Acoustic Research▼; Advent; Altec Lansing▼; Atlas▼; Audiotechniques; Audiotronics▼; Auernheimer▼; Auratone▼; Cetec-Gauss▼; Electro-Voice▼; Gotham Audio▼; Hammond; Heath; JBL▼; Koss; McCurdy▼; Orange County▼; Panasonic▼; Ramko▼; Sharp▼; Spectra Sonics▼; Superscope▼; Tandberg▼; Tapco▼; Technics▼; Telectro; UREI▼; US Pioneer▼; Yamaha▼

Studios
 1. cabinets and furniture
 2. acoustic materials and treatment
 3. complete studio construction

Accurate Sound 3▼; Aderhold 3; Allied Broadcast 1▼; BSC 1; Cetec 1.3▼; Delta (Long) 3; Dyma 1.3▼; Grinnan 1.3; Kreonite 1▼; Lauderdale 1; LPB 1▼; McCurdy 1.3▼; Micro-Trak 1▼; Optima 1; QRK 1▼; RCA 1▼; Ruslang 1▼; Stanton 1▼; Westlake 1-3; Whirlwind 1.3; Winsted 1▼

Synchronizing Equipment
 1. SMPTE time code systems
 2. pulse signal systems

Audiotronics 2▼; Automated Processes 1.2▼; BTX 1▼; Datametrics 1▼; Ecco 1▼; Gray 1▼; MCI 1▼; Skotel 1▼; Systron Donner 1▼; True Time 1▼

Tape, Magnetic
 1. open-reel tape
 2. cartridges
 3. cassettes
 4. test tapes

Agfa-Gevaert 1.3.4▼; Ampex 1-4▼; Aristocart 2.4▼; BASF 1-4▼; Broadcast Cartridge 2▼; Capitol Magnetic 2▼; DAK 1,2; Fidelipac 2.4▼; Fuji 1.3▼; IGM 2▼; Intl. Audio 3▼; 3M 1.3▼; Lauderdale 2-4; Magnetic Reference 4▼; Maxell 1-3; Nakamichi 3▼; Nortronics 4▼; Pentagon 3▼; Standard Tape 4; Superscope 1.3▼; Tapecaster 2; Tapex 3,4; TDK 1-4; Telex 2▼; UMC 2▼

Tape Accessories and Services
 1. empty reels, carts cassettes
 2. auto loaders
 3. leader tape
 4. tape timers
 5. tape cleaners
 6. tape cleaning and evaluating service
 7. tension gauges
 8. alignment gauges

R.B. Annis▼; Audico 2▼; Broadcast Cartridge 1▼; Broadcast Elect. 4-6.8▼; DAK 1.3; Dyma▼; Electro Sound 2; Fidelipac 1.8▼; Heath; Innovonics 7▼; Intl. Audio 7.8▼; 3M 1.3▼; Lauderdale 3,4; Marathon 1.2.5.7▼; Memorex▼; Miller-Stephenson 5▼; Nagra 4▼; Neumade 1▼; Nortronics 5▼; Pentagon 1▼; Plastic Reel 1.3; Ramko 2▼; Recording Supply 1.3▼; Recortec 2.5.6▼; Tapecaster 4; Tapex 1.3,7.8; TEA 5▼; Telex 1▼; Tentel 7▼; Texwipe 5▼; UMC 7.8▼; Westlake 5

Tape, Cartridge Player/Recorders
 1. single
 2. dual
 3. multiple
 4. time delay

Amilon 1▼; Ampro/Scully 3▼; Audi-Cord 1-4▼; Bell Audio 1▼; Broadcast Elect. 1-4▼; Cetec 1-4▼; Consolidated Elect. Ind. 1-3▼; Continental Electronic 1; Harris 1-3▼; IGM 1-4▼; Intl. Tapetronics 1-4▼; Mackenzie 1-4▼; Panasonic 1▼; Ramko 1-3▼; RCA 1▼; Sono-Mag 1-4▼; Superscope 1.2▼; T.A. 1▼; Telex 1▼; UMC 1-3▼

Tape, Cassette Player/Recorders

Amilon▼; Audiotronics▼; Edco▼; Lexicon; Nakamichi▼; Panasonic▼; Ramko▼; HH Scott; Sharp▼; Superscope▼; Tandberg▼; Teac▼; Technics▼; Telex▼; Variable Speech▼; Yamaha▼

continued on page 73



JVC's \$17,000 editing system.



If you think a third audio channel and 10 extra lines of resolution are worth an extra \$6000 in a 3/4" video editing system, read no further.

But if you'd like to save \$6000 compared to the nearest performing competitor...yet perform advanced editing functions at tape speeds up to 10 times normal (a JVC exclusive)...and produce broadcast quality tapes even if you're not an expert...then the CR-8500LU system including RM-85U Editing Control Unit is for you. It has many features you won't find elsewhere

except on that higher priced system. Plus some you won't find even there.

Fast, no-glitch editing

With pushbutton ease, you get distortion-free frame-to-frame editing, thanks to JVC's built-in rotary erase head, blanking switcher and advanced servo mechanism. First, you have a choice of 11 forward and rewind search speeds, from still-frame to an unequaled 10 times normal. After picking edit points, you also have a wide choice of automatic preroll times. (The more expensive

system limits you to 2 or 5 seconds.) Then you can preview your edits and adjust edit points. Preroll again, and edits are made automatically, electronically, at exactly the selected points ± 2 frames—an accuracy equal to the higher priced system. There's also a horizontal sync phase compensator to minimize timing error. A patented dubbing switch for maintaining stable color. And much more.

The RM-85U Editing Control Unit has independent LED displays for player and recorder. Each gives elapsed tape time in

For those who need funds, not frills.



minutes, seconds and frames. Or, the exact length of one edit—a JVC exclusive. But wait! Maybe you don't even need a full system.

Stand-alone versatility

Let's say you just want to assemble or insert edit live material onto a tape. All you need is one CR-8500LU Recorder/Editor... which still gives you the benefit of automatic preroll. By contrast, the higher priced brand makes you buy a control unit as well.

Let a JVC dealer show you how our editing system gives

you much more for your money. For the name of your nearest dealer, call one of these numbers collect: East, 212-476-8300; Midwest, 312-364-9300; South, 713-741-3741; West, 213-537-6020. US JVC Corp., 58-75 Queens Midtown Expressway, Maspeth, NY 11378.

JVC[®]
PROFESSIONAL VIDEO DIVISION
US JVC CORP.

BM/E 9/79

Mail to US JVC Corp.,
58-75 Queens Midtown Expressway,
Maspeth, NY 11378.

I'd like to know more about the
CR-8500LU editing system including
RM-85U Editing Control Unit.

Name _____

Title _____

Company _____

Address _____

City, State, ZIP _____

Phone _____

Type of operation _____

Circle 142 on Reader Service Card

www.americanradiohistory.com

The Technics isolated-loop system. It's the one big difference between their decks and ours.



Every one of Technics four open reel decks has one thing in common: The performance of Technics isolated-loop tape transport system. And that means performance that's comparable to professional open reel decks costing thousands of dollars more.

By isolating the tape from external influences, our isolated-loop tape transport system minimizes tape tension to a constant 80 grams. This not only provides extremely stable tape transport and low head wear, it also reduces modulation noise and wow and flutter to the point where they're detectable on only sophisticated testing equipment.

Electronically, our line of isolated-loop tape decks are equally impressive. The reasons are as simple as their IC full-logic transport controls, highly accurate microphone amplifiers, FET mixing amplifiers and separate 3-position bics/EQ selectors.

And you'll get all this technology whether you choose the two-track RS-1500, the extended playing time of the 4-track RS-1506 (shown above), the convenience of the

4-track RS-1700 with auto-reverse or the studio features of the RS-1520.

There's also an optional full-feature infrared wireless remote control (RP-070). With it you can get your hands on all this sophistication from up to 20 feet.

All four decks hit the competition right between the reels. Because all four have: **FREQ. RESP.**: 30-30,000 Hz, ± 3 dB (-10 dB rec. level) at 15 ips. **WOW & FLUTTER**: 0.018% WRMS at 15 ips. **S/N RATIO**: 57 dB (1506 & 1700) and 60 dB (1500 & 1520) NAB weighted at 15 ips. **SEPARATION**: Better than 50 dB. **START-UP TIME**: 0.7 sec. **SPEED DEVIATION**: $\pm 0.1\%$ with 1.0 or 1.5 mil tape at 15 ips. **SPEED FLUCTUATION**: 0.05% with 1.0 or 1.5 mil tape at 15 ips. **PITCH CONTROL**: $\pm 6\%$.

Technics open reel decks. A rare combination of audio technology. A rare standard of audio excellence.

Cabinetry is simulated woodgrain.

Technics

Professional Series

Circle 143 on Reader Service Card

Source Locator: AUDIO cont.

Tape, Open-Reel Player/Recorders

- portable
- studio systems
- time delay
- logging recorder

Accurate Sound 2▼; Ampex 1.2▼; Ampro/Scully 1.2▼; Consolidated Elect. Ind. 2▼; Dyma 3▼; Electro Sound 1.2; Gotham Audio 1.2▼; 3M 2.4▼; Magna-Tech 2▼; MCI 2▼; Nagra 1▼; Otari 1.2▼; Panasonic 2▼; Ramko 1.2▼; RCA 2▼; Sound Dynamics 2▼; Soundscriber 4▼; Superscope 2▼; Stancil-Hoffman 4; Studer Revox 1.2▼; Tandberg 1.2▼; Tape-Athon 2; Teac 2▼; Technics 2▼; Telectro 4; Telex 2.4▼; United Research 2▼; US Pioneer 2▼; VIF 2▼

Tape Heads

- replacement
- rebuilt

Accurate Sound 1▼; Ampex 1.2▼; Computer Magnetics 2; Forgflo 1; Grandy 1.2▼; Intl. Electro-Magnetics 1▼; Magna-Tech 1▼; Michigan Mag 1; Minneapolis Magnetics 1▼; Nortronic 1▼; Saki 1.2▼; Soundscriber 1▼; Taber 1.2▼; Tapex 1; UMC 1▼; VIF 1.2▼; Vikron 1▼

Tape, Duplicators

Accurate Sound▼; Audio Tek; Cetec Gauss▼; Electro Sound; Garner▼; Intl. Audio▼; Otari▼; Pentagon▼; Ramko▼; LJ Scully; Telex▼

Tape Editing Equipment & Accessories

- manual
- electronic open reel
- electronic cassette

Ampex 1.2▼; BTX 1.3▼; Central Dynamics 2.3▼; CMX 2.3▼; Eeco 2▼; Electro Sound 1; EMS 2▼; Fidelipac 1▼; Marathon 1▼; Nagy 1▼; Nortronic 2▼; Redding 1▼; Sharepoint 1▼; Westlake 1

Tape and Head Erasers

- head degaussers
- bulk erasers
- conveyor erasers

R.B. Annis 1▼; Cetec 2▼; Fidelipac 2▼; Garner 2.3▼; Lauderdale 1.2; Marathon 1▼; Microtran 1.2▼; Nortronic 2▼; Optek 2▼; Ramko 2▼; Soundscriber 2▼; Taber 2▼; Tapex 1.2; UMC 1.2▼; Wide Range 1.2

Tape Storage

- open-reel
- cartridge
- cassette

Aristocart 2▼; Broadcast Cartridge 2▼; Cetec 2▼; Dyma 1-3▼; Fidelipac 2▼; Grinnan 1.2; Lauderdale 2.3; Micro-Trak 2▼; Neumade 1-3▼; Simpax 2; Storeel▼; Tapex; Winsted 1-3▼

Telephone Coupling Equipment

Audio Accessories▼; Automated Processes; Broadcast Elect.▼; Channematic; Comrex▼; IGM▼; ITI▼; Kahn; Lauderdale; Microtran▼; Monroe▼; Nationwide; Redding

Audio Level Indicators

- VU
- PPM

Altec Lansing 1▼; Audio & Design Recording 1.2▼; Audio Technology 2; Crompton 1.2▼; Electro & Optical 2▼; ESE 1▼; Gotham Audio 1.2▼; International Instruments 1.2; MCI 1.2▼; Micimix 1.2▼; Nationwide 1; Quad-Eight 2▼; Ramko 1.2▼; RCA 1▼; Scott Instruments; Sharepoint 2▼; T.A. 1.2▼; Technics 2▼; TM 1; Triplett 1▼; 2005AD; UREI 1▼; Weston

II. VIDEO EQUIPMENT

Cameras, TV, Color Studio

- over \$50,000
- \$25-50,000
- below \$25,000

Ampex 1▼; Bosch Fernseh 1.2▼; Commercial Elect. 2▼; GBC 3; Harris 1-3▼; Hitachi 1-3▼; Ikegami 1.3▼; IVC 1▼; Marconi 1▼; Panasonic 3▼; Philips 1-3▼; RCA 1.2▼; Sharp 3▼; Thomson-CSF 1▼; Toshiba 1▼

Cameras, Studio/Field Convertible Color

Ampex▼; Asaca▼; Bosch Fernseh▼; Commercial Elect.▼; Harris▼; Hitachi▼; Ikegami▼; IVC▼; Marconi▼; NEC▼; Panasonic▼; Philips▼; RCA▼; Sharp▼; Thomson-CSF▼

▼ MEANS VERIFIED SOURCE

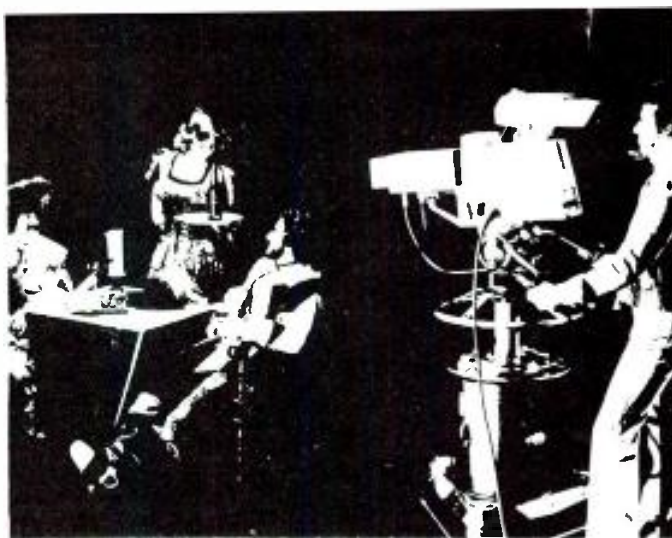

Cameras, TV, Portable ENG/EFP

- integral head/electronics
- separate head/electronics

Akai 1; Ampex 1▼; Asaca 1.2▼; Bosch Fernseh 1.2▼; Cinema Products 1▼; Commercial Elect. 2▼; GBC 1; Harris 2▼; Hitachi 1.2▼; Ikegami 1.2▼; IVC 2▼; Marconi▼; NEC 1▼; Panasonic 1▼; Philips 1.2▼; RCA 1.2▼; Sharp 1.2▼; Sony Broadcast 1▼; Sony 1▼; TeleMation 1▼; Thomson-CSF 1.2▼; Toshiba 1.2▼

Cameras, TV Mono

Dage/MTI▼; Electro & Optical▼; GBC; Hitachi▼; Ikegami▼; Marconi▼; Panasonic▼; RCA E-O▼; Sharp▼; Sony▼; TeleMation▼; Video Optics; Westinghouse▼

Camera Lenses and Accessories

AIC; Angenieux▼; AVA Elec.; Canon USA▼; Commercial Elect.▼; F&B Ceco▼; Fujinon▼; Harris▼; Javelin▼; Lenzar; Panasonic▼; Philips▼; Rank▼; RCA E-O▼; Shneider▼; Warren Smith▼; Tele-Cine▼; TeleMation▼; Tiffen▼; Visual Methods▼; Zoomar▼

Camera Heads, Mounts, Dollies, Etc.

- heads
- tripods
- pedestals
- stabilizing systems
- ENG camera braces
- cranes
- dollies

Arrivlex 2▼; Birns & Sawyer 1.2,7▼; Cine 60 5▼; Cinema Products 1.2,4▼; Dornell 6; ENG Mfg. 6▼; Alan Gordon 1.2▼; Gruber▼; Harris 1.2,4,7▼; Image Devices 2.5▼; Innovative 1-3,7▼; K&H 5.7▼; Kandit 5.7; Lee-Ray 7▼; Listec 1-3, 6, 7▼; O'Connor 1.2▼; CN Polites 6.7; Power-Optics 4; Quick-Set 1,2,5,7▼; Tele-Cine 4▼; Television Products 3▼; Van Ladder 6▼

Remote Control Mounts

American Laser▼; Canon USA▼; Electro & Optical▼; Harris▼; Innovative TV▼; Power-Optics▼

Character/Graphics Systems

- character/graphics generators
- alphanumeric generators

Ann Arbor Terminals 2▼; Boston Elect. 2▼; BJA 1; Chyron 1.2▼; Dynasciences 1▼; EECO 1▼; EEV 1▼; Electro & Optical 2▼; Interand 1▼; Kaitronics 2▼; Kallman 1.2; Knox 1▼; Laird 1.2▼; Listec 1.2▼; 3M 1.2▼; MPB 1▼; MSI 2▼; Panasonic 1▼; QSI 2▼; Reynolds/Leteron 1▼; Shintron 1.2▼; System Concepts 1.2▼; TeleMation 1.2▼; Thalner 1.2; Thomson-CSF 1.2▼; Video Data 1.2▼; Visual Methods 2

Chroma Keyers

- RGB
- encoded
- luminance

American Data 1▼; Broadcast Video 1-3▼; Central Dynamics▼; Crosspoint Latch 2▼; Dynasciences 2▼; Dytex▼; Grass Valley 1.2▼; Industrial Sciences 1.3▼; Intl. Nuclear 1▼; J&D; 3M 1▼; Panasonic 1▼; RCA 1▼; Richmond Hill; Shintron 2.3▼; Telemet 1▼; Thomson-CSF 1▼; Vamco

Image Enhancers

Asaca▼; Consolidated Video▼; Dynasciences▼; Edutron▼; Yves Faroudja▼; Kalart Victor; 3M▼; Microtime▼; Siegel▼; TeleMation▼; Telemet▼; Thomson-CSF▼

Video Noise Reducers/Filters

Consolidated Video▼; Digital Video▼; Edutron▼; MCI/Quantel▼; NEC▼; Philips▼; TeleMation▼; Thomson-CSF▼

Color Correctors

Broadcast Video▼; Computer Magnetics; Datatek▼; Electro & Optical▼; Harris▼; Ikegami▼; Microtime▼; NEC▼; RCA▼; Seigel▼; TEA▼; Thomson-CSF▼

continued on page 74

Source Locator: VIDEO cont.

Color Encoders Broadcast Video▼; Cohu▼; Crosspoint Latch▼; Harris▼; Ikegami▼; Lenco▼; MPB▼; Philips T&M▼; RCA▼; Telemet▼

Dropout Compensators Digital Video▼; 3M▼; Microtime▼; RCA▼

Film Telecine Equipment
 1. 16mm projectors
 2. slide projectors
 3. multiplexer
 4. complete systems
 5. film cart player
 Bell & Howell A/V 1.2,4; Bosch Fernseh 4▼; Buhl Optical 2,3▼; Cinema Products 4▼; CMX 4▼; Cohu 3,4▼; GBC, Kalart-Victor 1-4▼; Laird 2-4▼; L-W 1,4▼; Magna-Tech 1▼; Marconi▼; Multi-Track 1; Palmer 1▼; Philips 4▼; Rank 4▼; RCA 1-5▼; Warren Smith▼; TeleMation 3,4▼; Tele-Measurments 2; Zei-Mark 1-4▼

Picture Monitors
 1. b&w
 2. color
 3. DC portable
 Amtron 2,3▼; Asaca 1-3▼; Audiotronics 1▼; Bosch-Fernseh 2▼; Broadcast Video 2▼; Cohu 1▼; Conrac 1,3▼; Dage-MTI 1; Electrohome 1,2▼; Electro & Optical 1-3▼; GBC; Hitachi 1,2▼; Ikegami 1,2▼; Image Devices 2,3▼; Janson 1▼; Lectrotech 2▼; Panasonic 1,2▼; RCA E-O 1▼; Rohde & Schwarz 1,2▼; Sharp 2▼; Sony 1,3▼; Tektronix 1,2▼; TeleMation 1▼; Unimedia 2, Video Aids 1,2▼; Videotek 2,3▼; World Video 2,3▼

Monitor Calibrators Imero Fiorentino▼; Kallman; Power-Optics▼; TEA▼; Tektronix▼; Visual Information▼

Processing Amplifiers AVL Digital▼; Broadcast Video▼; Central Dynamics▼; CMC▼; Dynasciences▼; Edutron▼; Grass Valley▼; Harris▼; J&D; Leitch Video▼; Lenco▼; 3M▼; Richmond Hill; Siegel▼; Tektronix▼; TeleMation▼; Versa-Count▼; Vital▼

Pulse & Distribution Amplifiers
 1. pulse
 2. distribution
 3. subcarrier
 American Data 1-3▼; Applied Video 1-3; AVA Elec. 2; AVL Digital 1,2▼; Broadcast Video 1-3▼; Central Dynamics 1,2▼; Channelmatic 2▼; Coastcom 3▼; Cohu 1-2▼; Dage/MTI 2▼; Datatek 1-3▼; Di-Tech 1▼; Dynair 1-3▼; Dynasciences 1-3▼; Edco 1,2▼; GBC 1,2; Grass Valley 1,3▼; Harris 1-3▼; Industrial Sciences 1-3▼; Intl. Nuclear 1-3▼; J&D 1,2; Leitch 1-4▼; Lenco 1,2▼; 3M 1-3▼; Marconi 1-3▼; NEC 1,3▼; Panasonic 1,2▼; Richmond Hill; Shintron 1,3▼; Sigma 1-3; TeleMation 1-3▼; Telemet 1,2▼; Thalner 1,2▼; Varian 1▼; Video Aids 2▼; Viscount 2▼; Vital 1-3▼

Production Switchers
 1. large
 2. small
 3. automated
 American Data 1,2▼; Ampex 1,2▼; Asaca 2▼; Avonix 2▼; Beaveronics 1,2▼; Broadcast Video 2▼; Camera Mart 2▼; Central Dynamics 1,3▼; Centro 2▼; Crosspoint Latch 2▼; Dage/MTI 2▼; Dynasciences 2▼; Dytek 1-3▼; Electro & Optical 2▼; Grass Valley 1-3▼; Ikegami 1,2▼; Image Video 2▼; Industrial Sciences 1,2▼; Intl. Nuclear 1,2▼; J&D 1,2; Lnes 2, 3M 1-3▼; Marconi▼; Oak; Panasonic 1,2▼; Philips 2▼; QSI 2▼; Richmond Hill; Ross 1-3▼; Shintron 2▼; Sony 2▼; TeleMation 1-3▼; Telemet 2▼; Toshiba 2▼; Viscount 1,2▼; Vital 1-3▼

Master Control Switchers American Data▼; Beaveronics▼; Broadcast Video▼; Central Dynamics▼; Comad; Grass Valley▼; Image Video▼; Industrial Sciences▼; Intl. Nuclear▼; Ross▼

Automated Master Control Systems American Data▼; AVL Digital▼; Central Dynamics▼; Comad; Grass Valley▼; Image Video▼; Microtime▼; NEC▼; Video Specialties▼; Vital▼

Post Production Switchers American Data▼; Beaveronics▼; Broadcast Video▼; Electro & Optical▼; Grass Valley▼; Intl. Nuclear▼; J&D; Vital▼

Routing Switchers American Data▼; Boston Elect.▼; Broadcast Video▼; Central Dynamics▼; Comad▼; Datatek▼; Di-Tech▼; Dyma▼; Dynair▼; Dytek▼; Edco▼; Electro & Optical▼; Grass Valley▼; Image Video▼; Intl. Nuclear▼; J&D; Lenco▼; 3M▼; NEC▼; Richmond Hill; Sigma; TeleMation▼; Telemet▼; Utah Scientific▼; Vamco; Viscount▼; Vital▼

Special Effects Generators American Data▼; Asaca▼; Beaveronics▼; BJA; Broadcast Video▼; Central Dynamics▼; Chyron▼; Colorado Video▼; Crosspoint Latch▼; Dynair▼; Dytek▼; GBC; Grass Valley▼; Image Video▼; Industrial Sciences▼; Intl. Nuclear▼; J&D; 3M▼; MCI/Quantel▼; Panasonic▼; Philips▼; Richmond Hill; Shintron▼; Sony▼; TeleMation▼

▼ MEANS VERIFIED SOURCE

Signal Equalizing Systems Datatek▼; Di-Tech▼; Grass Valley▼; Intl. Nuclear▼; Lenco▼; Telemet▼; Vital▼

Sync Generator Systems
 1. sync
 2. color bar
 3. black burst
 4. stairstep/ramp
 5. multiburst
 6. digital sync decoder
 Asaca 1,2,4,5▼; Broadcast Video 1-5▼; Cohu 1▼; Crosspoint Latch 1-3▼; Dage/MTI 1▼; Datatek 3▼; Dynair 1,3▼; Dynasciences 1,2▼; GBC 1; Grass Valley 1,3▼; Ikegami 1▼; Industrial Sciences 1-3▼; J&D 3; Leitch 1-6▼; Lenco 1,3▼; 3M 1,3▼; Panasonic 1,2▼; Philips T&M 1▼; QSI 2▼; Richmond Hill 1; Sharp 1-3▼; Shintron 1-3▼; Sigma 1,3▼; Sony▼; Tektronix 1-5▼; TeleMation 1,3,6▼; Telemet 2,4,5▼; Thalner 1▼; Video Aids 1,3▼; Viscount 1▼

Standards Converters Marconi▼; MCI/Quantel▼

Synchronizers
 1. frame
 2. field
 ADDA 1▼; Arvin Echo 1,2▼; BTX 1,2▼; Consolidated Video 1▼; Digital Video 1,2▼; Grass Valley 1▼; MCI/Quantel 1,2▼; Microtime 1▼; NEC 1▼; RCA 1▼; Thomson-CSF 1▼

Time Base Correctors
 1. helical capstan servo
 2. helical non-servo capstan
 3. quad
 Ampex 1,2▼; Consolidated Video 1-3▼; Digital Video 1-3▼; Edutron 1,2▼; Eigen 1▼; Merlin▼; MCI/Quantel 1-3▼; Microtime 1-3▼; NEC 1,3▼; Philips 1▼; RCA 1▼; Siegel 1▼; Sony Broadcast 1▼

Videotape
 1. new tape
 2. tape cleaning & evaluating
 3. reprocessed tape
 Agfa-Gevaert 1▼; Ampex 1▼; BASF 1, Calico Video 1▼; Chyron 2▼; Compact Video 2▼; DAK 1; Du Pont 1; Fuji 1▼; Intl. Audio 1▼; Keyline; 3M 1▼; Maxell 1; Media Concepts 1▼; Memorex 1▼; Recortec 2▼; Sony 1▼; Studio Tape 1-3▼; TDK 1; TEA 2▼; Videotape Co. 1,2▼

Videotape Accessories
 1. tape cleaners
 2. VTR head cleaners
 3. reels
 4. tape evaluators
 5. storage
 6. tape tension gauge
 7. rewinder
 8. bulk erasers
 9. replacement heads
 Ampex 9▼; R.B. Annis; Arvin Echo 9▼; Calico Video 3▼; Cezar Intl.▼; Computer Magnetics 9; Dyma 1,5▼; Garner 8▼; Kaitronics 4▼; 3M 3,5▼; Memorex▼; Neumade 5,7▼; Nortronics 1▼; Nova 1; Optek 8▼; RCA 9▼; Recording Supply 3▼; Recortec 1,4,7▼; Saki 9▼; Spin Physics 9▼; Studio Tape 1,3,4▼; Taber 8,9▼; TDK 1; TEA 1-4▼; Tentel 6▼; Texwipe 1,2▼; TRI 5▼; Videomax 9▼; Winsted 5▼

Videotape Recorder/Players
 1. quad
 2. helical
 3. segmented-helical
 4. helical cassette
 5. automated systems
 Ampex 1,2▼; Arvin/Echo 2,5▼; Asaca 1▼; Bosch Fernseh 3-5▼; Hitachi 2▼; IVC 2,3▼; Janson 2▼; Marconi 2▼; Media Concepts 5▼; Merlin 1,4▼; NEC 2,5▼; Phascom 5▼; Philips 2,3▼; QSI 2▼; RCA 1-5▼; Recortec 3-5▼; Sharp 3▼; Sony Broadcast 2,4,5▼; Sony 4▼

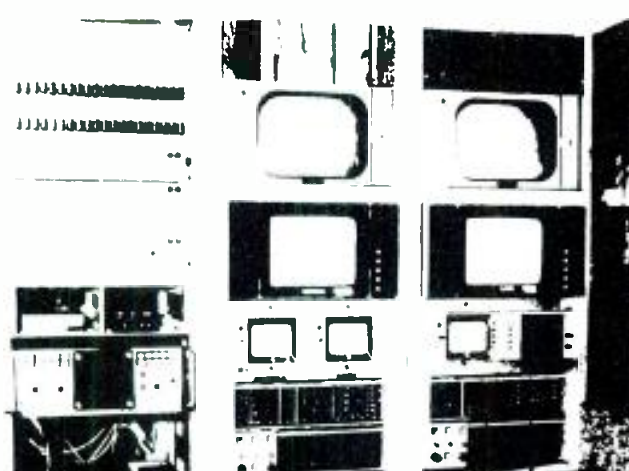

continued on page 76

FIELD EVALUATION REPORT CARD

PRODUCT: *TFT 7700 STL*
ACHIEVEMENT

EVALUATION PERIOD: *5/79-7/79*
COMMENTS

Category	Site 1	Site 2	Site 3	Site 4	Comments
Sound	✓	✓	✓	✓	70 dB signal to noise 40 dB stereo separation from 50 Hz to 15 kHz
Power Output	✓	✓	✓	✓	Demonstrates 12 watts maximum No signal degradation over long transmission
Frequency Stability	✓	✓	✓	✓	Excellent solid state
Security	✓	✓	✓	✓	Automatic transfer and alarm no interference
Design	✓	✓	✓	✓	Very easy to service in field
Maintenance	✓	✓	✓	✓	

AT THE TOP OF ITS CLASS

The field tests are done...the results are in...and the scores support our highest expectations for TFT's new Series 7700 Studio Transmitter Link. Our goal was to offer a fully secure, low noise link with enough power to economically compete with telephone line systems over the roughest transmission terrain. From Shell Plaza in downtown Houston to Mt. Sutro in San Francisco, we put the 7700 through its paces; comparing noise, security, frequency stability, crosstalk and power against the toughest customer demands and the best that competition had to offer. Individual performance tests were evaluated by chief engineers from several of the top stations in the country. The results — TFT Series 7700 won hands-down in every category considered vital to a studio transmitter link.

QUALITY SOUND: 70 dB S/N ratio and 40 dB stereo separation from 50 Hz to 15 kHz; with 50 dB @ 1 kHz crosstalk between main and subchannels.

SECURITY: Fully redundant receiver and transmitter, both with automatic transfer and alarm.

FREQUENCY STABILITY: Fully frequency synthesized transmitter.

POWER: Adjustable up to 12-watts to compensate for degradation and handle long and difficult terrain.

ECONOMY: Modular design for easy field servicing. Sealed solid state components.

All sound too good to be true? We'd like to show you our recent field test reports and complete specifications, so you can judge our STL for yourself. Call or write TFT.

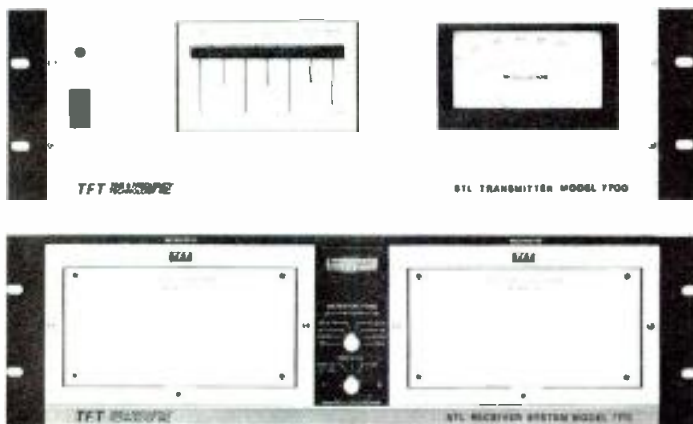

TFT TIME AND FREQUENCY TECHNOLOGY, INC.
3090 OAKMEAD VILLAGE DR, SANTA CLARA, CA 95051 408 246-6365 TWX 910-338 0584

Circle 144 on Reader Service Card

www.americanradiohistory.com

Source Locator: VIDEO cont.

VTR Head and Machine Rebuilding
 1. head refurbishing
 2. machine rebuilding

AF Associates 2▼; Ampex 1▼; Applied Video 2; Arvin/Echo 1▼; CMC 1▼; Computer Magnetics 1; Merlin 2▼; RCA 1,2▼; Recortec 2▼; Saki 1▼; Spin Physics 1▼; Taber 1▼; Videomax 1▼

Quad Cartridge/Cassette Equipment
 1. players/recorders
 2. automation controllers
 3. complete automation systems
 4. reloaded carts

Ampex 1,2▼; AVL Digital 2▼; Calico Video 4▼; Central Dynamics 2,3▼; Channelmatic 2,3; Grass Valley 2▼; Marathon Products 4; Microtime 2▼; Phasecom 2▼; Programmable Systems 3; RCA 1,2,4▼; Re-Play 4▼; Richmond Hill 2; Video Tape Co. 4▼; Video Specialties 2▼

Videotape Editing
 1. two VTR editor-controller
 2. computer-assisted editor
 3. time code generator/reader
 4. audio/video recorder synchronizer

AF Associates 1▼; Ampex 1-4▼; Arvin/Echo 1▼; Avonix 1▼; BTX 1-4▼; Central Dynamics 2,4▼; Chrono-log 3▼; CMX 1-4▼; Consolidated Video 2▼; Convergence 1-3▼; Datametrics 3▼; Datatron 1-3▼; Dyma 3,4▼; Dynasciences 1▼; Dytek 1▼; EECO 2▼; Electro & Optical 3,4▼; EMS 1,2▼; Gray 3▼; Kaitronics 3▼; Marconi▼; Media Concepts 3▼; Microtime 3▼; Microvision 1▼; Oregon Magnetics 4; Panasonic 1▼; Philips 4▼; QSI 3▼; RCA 1-3▼; Shintron 3▼; Skotel 3▼; Sony Broadcast 1,3▼; Sony 1▼; Tech Elect. 1; TeleMation 2,3▼; United Media 1-4▼; Video Aids 1,4▼; Videomedia 1,2▼

Video Identification Systems

Broadcast Video▼; BTX▼; Dynasciences▼; NTI▼; QSI▼; RCA▼; Thalner▼

Video Delays, Filters
 1. delay lines
 2. filters

American Data 1▼; Anders 1; Broadcast Video 1,2▼; Coastcom 2▼; Corning Glass 1; Datatek 2▼; Yves Farovdja 2▼; Kappa 1,2; Leitch 1▼; Lenco 1▼; Listec 1▼; Sawyer Industries 1; TEA 1,2▼; TT 2

Video Action Recorders
 1. slow motion
 2. variable speed
 3. time lapse

Ampex 1-3▼; Arvin/Echo 1-3▼; Bosch Fernseh 1,2▼; Eigen 1-3▼; GYYR 3; Marconi 1,2▼; Oktel 1-3; QSI 3▼

Electronic Still Stores

ADDA ▼; Ampex▼; Arvin/Echo▼; Bosch Fernseh▼; Colorado Video▼; Consolidated Video▼; Eigen▼; NEC▼; Oktel

Video Effects Devices
 1. digital video effects
 2. colorizer
 3. synthesizer
 4. repositioner
 5. compressor
 6. animation

BJA 2,3,6; Bosch Fernseh 1▼; Broadcast Video 1,2▼; Colorado Video 2,4▼; Computer Image 6▼; Crosspoint Latch 2▼; Dynasciences 6▼; Eigen 6▼; Grass Valley 1,2,4,5▼; J&D 2; 3M 1,2▼; MCI/Quantel 1,4-6▼; NEC 1,4,5▼; Power-Optics; RCA 1,5▼; TeleMation 1,3,6▼; Thomson-CSF 2▼; Video Modular 1-6▼; Vital 1▼

Video Equipment, Misc.
 1. automatic telecine light control
 2. video film noise reducers
 3. comb decoders
 4. equalizers
 5. A/D converters
 6. video presence detector
 7. video slater/prompter
 8. test materials
 9. power packs, portable video camera
 10. auto skew corrector
 11. large screen projectors
 12. video lock to mag. film recorder
 13. video attenuators
 14. video test charts & slides

Advent 11▼; Arvin/Echo 3,5▼; AVL Digital 6▼; Beston Elect. 1,7▼; Broadcast Video 3▼; BTX 12▼; Cezar Intl. 6▼; Channelmatic 6; Christie 9▼; Cine 60 9▼; Cinema Products 9▼; CMC 4▼; Cohv 1; 4▼; Colorado Video 6; 15▼; Computer Labs 5▼; Computer Magnetics 4; Comsonics 6; Conrac East 11▼; Corley 14; Datatek 4▼; Digital Video 1,3,5▼; Di-tech 4,6▼; Dynair 4▼; Edutron 10▼; Yves Farovdja 3▼; Imero Fiorentino 8,11▼; Frezzolini 9▼; GE Video Display 11▼; Grass Valley 4▼; Image Magnification 11▼; Industrial Sciences 1▼; ITI 4▼; J&D 4; Kalart Victor 11; 13; Kings; Laird 1▼; Leitch 4▼; Lenco 3,4,6▼; Listec 7▼; Magna-Tech 12▼; MCI/Quantel 5▼; Multiplier 9▼; Multi-Track 12; NEC 9▼; Philips T&M 8,14▼; Porta-Pattern 8,14▼; Power-Optics 8; Projection Systems 11; Q-TV 7▼; Sharepoint 6▼; Skotel▼; Sony 11▼; Studio Tape▼; Tech Labs 13▼; Tektronix 5,14▼; TeleMation 1▼; Tele-Measurements 14; Telescript 7▼; TEA 4▼; Television Products 9▼; Thomson-CSF 2▼; Torpey; Ultra Audio 14▼; Video Aids 6▼; Visual Information 14▼

▼ MEANS VERIFIED SOURCE

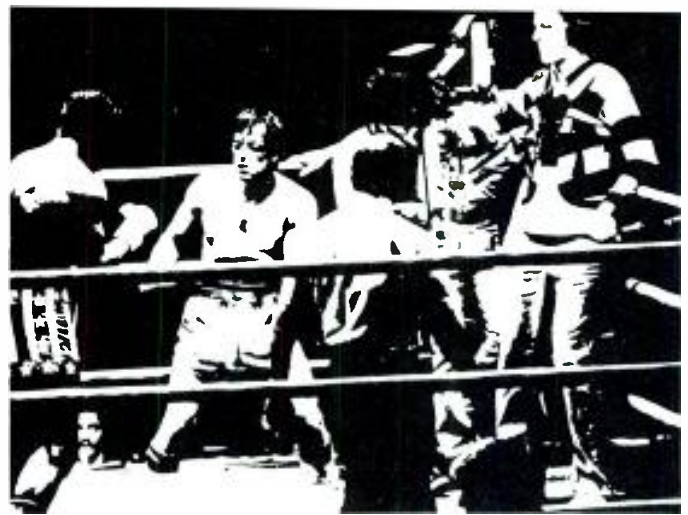

III. FILM EQUIPMENT

Cine Cameras

AIC; Allied Impex; Arriflex▼; Bach Auricon; Beaulieu▼; Bell & Howell A/V▼; Canon Scoopic▼; Cinema Products▼; Eastman Kodak▼; Frezzolini▼; General Camera; Harris▼; L-W▼; Palmer▼

Cine Camera Lenses & Accessories

AIC; Allied Impex; Angenieux▼; Arriflex▼; Bell & Howell▼; Canon Scoopic▼; Canon USA▼; Century Precision▼; Cinema Products▼; F&B Ceco▼; Fujinon▼; Harris▼; Javelin▼; Lenzar; Rank▼; Schneider▼; Warren Smith▼; Tele-Cine▼; Tiffen▼; Zoomar▼

Cine Camera Tripods & Accessories

Arriflex▼; Bardwell & McAlister; Bach Auricon; Birns & Sawyer▼; Cinema Products▼; F&B Ceco▼; Alan Gordon▼; Harris▼; Image Devices▼; Listec▼; O'Connor▼; CN Polites

Cine Camera Carrying Cases

Bardwell & McAlister; F&B Ceco▼; Frezzolini▼; Image Devices▼; Neumade▼; Plastic Reel; Thermodyne▼

Film Stock

Agfa-Gavaert▼; Eastman Kodak▼; Studio Film▼

Film Storage Cases

Bardwell & McAlister; Neumade▼; Plastic Reel; Thermodyne▼

Film Cleaners

Bardwell & McAlister; Lipsner-Smith▼; Neumade▼; Plastic Reel; RTI▼

Film Editing Equipment

Bardwell & McAlister; Birns & Sawyer▼; Cinema Products▼; Kalart Victor▼; Magnasync/Moviola▼; Neumade▼; Plastic Reel; RTI▼

Film Processors

AIC; Eastman Kodak▼; Filmline; Houston Fearless▼; Houston Photo; Jamison; Krconite▼; Pako; Treise▼

Film Projectors
 1. motion picture
 2. slide
 3. flickerless

Buhl Optical 2▼; Eastman Kodak 1▼; Alan Gordon 1▼; Kalart Victor 1▼; L-W 1,3▼; Mackensie 1,2; Magna-Tech 1,3▼; Palmeri▼; Rangertone 1,2▼; Singer Education 1,2

Magnetic Film Stock
 1. recording
 2. test

Agfa-Gavaert 1,2▼; 3M▼; Studio Film 1▼

Magnetic Film Recording Equipment

Frezzolini; General Camera; Image Devices▼; Magna-Tech▼; MCI▼; Multi-Track; Rangertone▼; Standard Tape; Transist-O-Sound▼; Wide Range

Film, Misc.
 1. pollution control, silver recovery
 2. slide masks & mounts
 3. multi-lock, video and magnetic film
 4. film inspection equipment

BTX▼; CPAC 1▼; Houston Fearless 1▼; Image Devices▼; Magna-Tech 3▼; Neumade 4▼; Pako 2; Rangertone▼; Raven▼; RTI▼; Variable Speech▼; Wide Range; Winsted▼

continued on page 78

You Work Under Pressure, So Do Our Editors

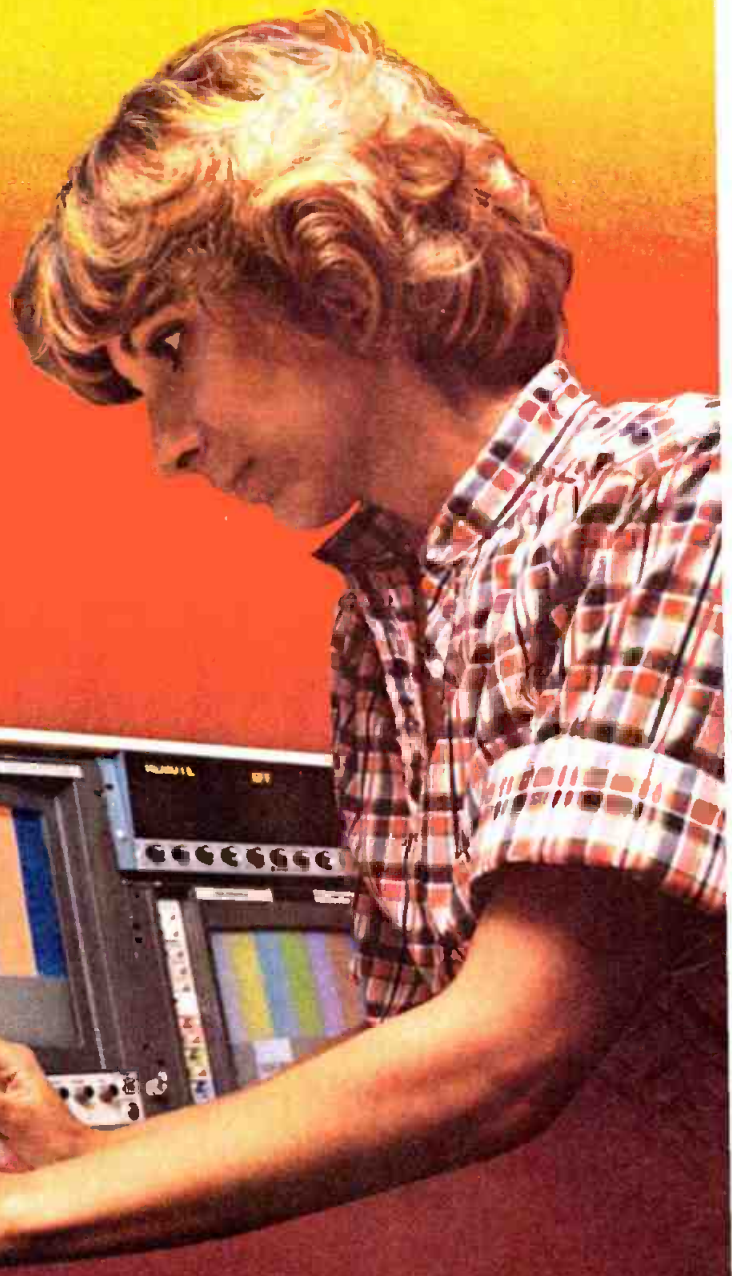

"25 people use our six Dynasciences editors daily, including reporters who must edit their own stories. There's no time to teach them complicated editor operation. Not one has had trouble learning to make quick, accurate edits with a Dynasciences editor."

*Ardell Hill, Technical Supervisor
WALA-TV, Mobile, Alabama.*

In today's fast-paced communications world, why do many top notch professionals like Ardell Hill rely on Dynasciences basic, post production and ENG editors? Because when the pressure is on, our editors deliver the most reliable, accurate edits possible in any format.

A full range of professional features substantially re-

duces production and maintenance costs. Standard controls are human engineered for ease of operation. Our patented positive reverse drive system (PRDS) reduces tape tension on reverse modes and minimizes wear. The exclusive Digital Insert Memory assures precise out-cueing of insert edits. And there's much more.

If YOUR EDITORS aren't keeping pace with your needs, it's time you moved up to a DYNASCIENCES EDITING SYSTEM. Call or write us today for more information.

DYNASCIENCES VIDEO PRODUCTS

Dynasciences A Unit of Whittaker Corporation, Township Line Road, Blue Bell, PA 19422 215/643-0250 Telex 846358

Whittaker

Circle 145 on Reader Service Card

www.americanradiohistory.com

Source Locator

IV. LIGHTING/SET DESIGN

Lamps	Barbizon; Bardwell & McAllister; Belden Communications; F&B Ceco; General Electric; GTE Sylvania; Lowel-Light; Packaged Lighting
Lighting Hardware & Accessories 1. heads, stands and fixtures 2. diffusion material 3. gels and filters	Barbizon 1-3; Bardwell & McAllister 1-3; Belden Communications 1-3; Berkey Colortron 1.3; Birns & Sawyer 1; Cine 60 1; Cinema Products 1; Electro Controls 2; F&B Ceco 1-3; Imero Fiorentino; Great American Market 1; Hammond; Harwood 1; Janson 1; Kliegl 1; Kreonite 1; Lowel-Light; Lumitrol; Packaged Lighting 1; Mole-Richardson 1-3; Olsen 1-3; CN Polites 1; Rosco 1-3; Smith-Victor 1.3; Strand Century
Light Control Systems 1. manual 2. automated 3. dimmer packs	Stanley Ash 1-3; Barbizon 1.2.3; Bardwell & McAlister 1.2.3; Berkey Colortron 1.2.3; Custom Audio 1; Electro Controls 1-3; Electronics Diversified; Great American Market; Hammond; IGM 2; Kliegl 1-3; Lumitrol; Mackenzie 2; Mole-Richardson 3; Olsen 3; Packaged Lighting; Sharepoint 1-3; Skirpan 1-3; Strand Century; TeleMation 2; Theatre Techniques 1-3
Patch Terminals	Stanley Ash; Barbizon; Berkey Colortron; Electro Controls; Electronics Diversified; Kliegl; Skirpan; Strand Century; Theatre Techniques; Union
Plugs & Connectors	Barbizon; Bardwell & McAlister; Electro Controls; Kliegl; Mole-Richardson; Strand Century; Union
Set Design/Scenery	Imero Fiorentino; Janson; Lumitrol; Olsen; Rosco; Television Products; Uni-Set
Seamless Material	Stanley Ash; Bardwell & McAllister;

V. RF/TRANSMITTING/RECEIVING EQUIPMENT

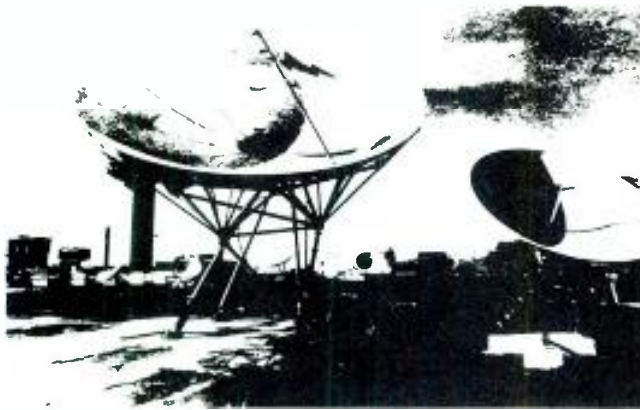

Demodulators	Catel; Coastcom; Comark; Electro & Optical; Farinon; Fung; Harris; McMartin; Microwave Assoc.; Optek; Phasecom; QSI; Scientific-Atlanta; Tektronix; Telemet; Townsend; Wilkinson
Diplexers	Alford; Canadian GE; CCA; Coastcom; Comark; Continental Elect.; CSP; DBC; Dielectric; Farinon; Harris; Jampro; Micro Communications; Mu-Del; Multronics; NEC; Shively; Soll; Thomson-CSF; Townsend; Varian

▼ MEANS VERIFIED SOURCE

Exciters	Acrodyne; Bayly; CCA; Cetec; Collins-Rockwell; Comark; Farinon; Harris; LFB; McMartin; Motorola; NEC; Philips; QEI; Scientific-Atlanta; Sintronic; Solid; Townsend; Varian; Versa-Count; Wilkinson
Modulators	Bayly; Catel; CCA; Coastcom; Comark; DBC; Electro & Optical; Farinon; Fung; Harris; McMartin; Microwave Assoc.; NEC; Phasecom; Scientific-Atlanta; Telemet; Time & Frequency; UHF; Varian
STLs 1. microwave 2. telco 3. waveguide	Avantek 1; Bayly 1; Catel 1; Gabriel 3; GTE Lenkurt 1; Dielectric 3; Intl. Microwave 1; Marti 1; Micro Control; Microwave Assoc. 1; Moseley 1; Nationwide; NEC 1; Nurad 1; Prodelin 3; RF Technology 1; Terracom 1; Time & Frequency 1
Microwave Equipment 1. intercity 2. portable 3. ENG 4. supports, portable equipment	Alford; Bayly 1; Catel 1; Coastcom 4; Collins-Rockwell 1; Compact Video 2.4; Comrex 3; E-N-G 3.4; Farinon 1-3; GTE Lenkurt; Hitachi 3; Hughes 1; Intl. Microwave 1-3; Marti 1-3; Microwave Assoc. 1-3; Microwave Power; Moseley 1-3; NEC 1-3; Nurad 3; RF Technology 2.3; RHG; Soldadyne; Systron Donner; Tayburn 1-3; Tepeco; Terracom 1-3; Van Ladder 4; Varian 1; Visual Methods 2
Remote Pickup Equipment	American Laser; Gorman-Redlich; Intl. Microwave; Marti; McMartin; Moseley; Nationwide; NEC; Tayburn
Remote Control Systems/ATS	American Laser; Bayly; CCA; Channelmatic; Comark; CSP; Delta; Dyma; Edcor; GTE Lenkurt; Hallikainen; Marti; Micro Control; Monroe; Moseley; Nurad; Potomac; PWH; Rivers; Tayburn; Time & Frequency
Receivers, Communication & Monitor	Bayly; Comrex; DBC; Elcom; Gorman-Redlich; Lampkin; McKay Dymek; Monroe; Nat'l. Electrolab; QEI; Rohde & Schwarz; Ken Schaffer; Scientific Radio; Rivers; Sequerra; Tandberg; Tayburn; Tepeco; Time & Frequency; US Pioneer
RF Amplifiers	Acrodyne; Ava Elec.; Barker & Williamson; Bayly; Belar; Blonder-Tongue; Comark; DBC; EEV; Elcom; Electronics M&C; Harris; Marti; Microwave Assoc.; Microwave Power; Moseley; Mu-Del; Nat'l. Electrolab; QEI; RHG; Tayburn; Television Technology; Townsend; Varian; Versa-Count; Wide Band; Wilkinson
Attenuators	Ailtech; Ava Elec.; Bayly; Bird; Comark; DBC; Electro Controls; ITI; McGraw-Edison; Micro Communications; Microwave Assoc.; Mu-Del; Quad-Eight; Tech Labs; Television Technology; Telonic; Trompeter; Varian
RF Converters	American Microsignal; Bayly; California Instruments; Comark; DBC; Microwave Assoc.; Mu-Del; Phasecom; Television Technology
RF Filters	Bald Mountain; Bayly; Bird; Blonder-Tongue; Catel; Coaxial Dynamics; Comark; CSP; DBC; ESC; Jampro; Micro Communications; Microwave Assoc.; Mu-Del; Multronics; Phelps Dodge; Shively; Tayburn; Television Technology; Telonic; Texscan; TT; Varian
RF Loads	Alford; Bayly; Bird; Blonder-Tongue; Coaxial Dynamics; Comark; Continental Elect.; CSP; Dielectric; Electro Impulse; Micro Communications; Microwave Assoc.; Shively; Television Technology; Telonic; Varian
RF Switchers	Bayly; CCA; Coaxial Dynamics; Comark; CSP; DBC; Delta; Dielectric; Dyma; Harris; ITT Jennings; Magnacraft; Marti; Micro Communications; Microwave Assoc.; Soll; Tayburn; Texscan; Wide Band

"We evaluated all carts and have standardized on the Audiopak® AA-3"

—Bob Kanner
Chief Engineer
KATH, FM 101
KHJ, AM 93
Los Angeles

"Our test results show that the Audiopak® AA-3 holds stereo phasing better than any other cart on the market."

"The excellent phase stability of the AA-3 will be of major importance as AM stations convert to stereo."

"The High Output, Low Noise (HOLN) tape in the AA-3 gives us excellent frequency response combined with 6db more headroom."

"The AA-3 maintains excellent tape motion with low wow and flutter."

"We had had previous cart pressure pad problems with our multiple playback machines — these have been resolved by the durability of the AA-3 pressure pads."

"The AA-3 is the 'state of the art' in cartridges — it meets or exceeds the specifications of the current NAB standards."

Capitol

Capitol Magnetic Products
A Division Of Capitol Records, Inc.
1750 North Vine Street
Los Angeles, California 90028

New Audiopak® AA-3 Broadcast Cartridge

Source Locator: RF/TRANSMITTING cont.

Satellite Earth Stations Alden 2; Andrew 1,2; Antennas for Comm. 2▼; 1. transmit/receive; 2. receive only
Avantek 1,2; Channelmatic 1,2; Coastcom 1,2▼; Collins-Rockwell 1,2▼; Farinon 2▼; Fort Worth; Gardner 1,2▼; Harris 1,2▼; Hughes 2; Microwave Assoc. 2▼; Moseley 1,2▼; NEC 2▼; Prodelin; Scientific-Atlanta 1,2▼; Terracom 2▼; Varian▼

SCA Equipment CSI▼; Fixtune▼; Harris▼; Johnson Elect; McMartin▼; Micro Control▼; Moseley▼; Nationwide; QEI▼; Rivers; Sharepoint▼; Solid▼

Translators Acrodyne 2▼; Belar 1,2▼; CCA 1▼; Cetec 1▼; 1. FM; 2. TV
DBC 2▼; Electronics M&C 2▼; Harris 1,2▼; Kitchen 1,2; Marti 1▼; McMartin 1,2▼; NEC 1,2▼; Rodelco 1,2; Rohde & Schwarz▼; Television Technology 1,2▼; Tepco 1,2▼; Thomson CSF/LGT 2▼; Time & Frequency 1▼; Varian Beverly 2▼; Versa-Count 1,2▼

Transmitters, AM Bayly▼; CCA▼; Cetec▼; Collins-Rockwell▼; Continental Elect.▼; CSI▼; Harris▼; LPB▼; Marconi▼; McMartin▼; NEC▼; RCA▼; Singer Prods.; Sintronic▼; Wilkinson

Transmitters, FM Bayly▼; CCA▼; Cetec▼; Collins-Rockwell▼; CSI▼; Harris▼; LPB▼; Marconi▼; McMartin▼; Microwave Power; NEC▼; QEI▼; RCA▼; Scientific Radio; Singer Prods.; Sintronic▼; Solid▼; Television Technology▼; Versa-Count▼; Wilkinson

Transmitters, TV Acrodyne 1,2▼; Canadian GE 1,2▼; CCA 1,2▼; 1. VHF; 2. UHF
Comark 1,2▼; DBC 1,2▼; Electronics M&C 1,2▼; Harris 1,2▼; Marconi 1,2▼; Microwave Power; NEC 1,2▼; Phillips 1,2▼; RCA 1,2▼; Television Technology 2▼; Thomson-CSF/LGT 1,2▼; Townsend▼; Varian 2▼

Misc. RF Equipment AEL 8,9; Alden 4; American Technology 8▼; Andrew 8; AVA Elec. 5,6,8; Barker & Williamson; Belden 6,8▼; California Instruments 9▼; CCA 3,5,6-8▼; Coastcom 1,2,7▼; Coaxial Dynamics; Comark 3,5,6,8,9▼; CSI 2▼; CSP 3; Delta▼; Dynatech 8; Elcom▼; Electro Controls▼; Gabriel 8▼; GTE Lenkurt 1▼; Harris 6,7▼; ITT Jennings 8▼; Jampro 3,5▼; Kahn; Kay Industries 9; Kings 8▼; LPB 2▼; Marti 1▼; McMartin 1,2,7▼; Micro Communications 5,6,8▼; Microwave Assoc. 1,5,8▼; Moseley 1,7▼; Multronics 3▼; Oak 8; Orban 7▼; Panduit 8▼; Phelps Dodge 6; QEI▼; QSI; RCA Dist.▼; Ripley; Rivers 1; SGL Waber 8; Sharepoint 1▼; RMS 6,8; Solid 1▼; SWR 6,8▼; Tayburn 3▼; Telautograph 4▼; Telemet▼; Television Technology 5,6,9▼; Thomson-CSF▼; Time & Frequency 1▼; Townsend▼; Trompeter 6,8▼; United Systems 9▼; Whirlwind 6,8; Wide Band▼

VI. ANTENNAS/TOWERS/TRANSMISSION LINES

Antennas, AM Andrews Tower; Bayly▼; Continental Elect.▼; Hy-Gain▼; Jampro▼; Marconi▼; Multronics▼; RCA▼; Rohde & Schwarz▼; Scala; Utility Tower

Antennas, FM Alford; Bayly▼; Blonder-Tongue; CCA▼; Cetec▼; Collins-Rockwell▼; Comark▼; Harris▼; Hy-gain▼; Jampro▼; Marconi▼; McMartin▼; Micro Communications▼; Phelps Dodge; RCA▼; Rhode & Schwarz▼; Scala; Shively▼; Singer Prods.

Antennas, Microwave Ailtech▼; Alford; Andrew; Anixter-Mark; Antennas for Comm.▼; Bogner▼; Cablewave▼; Comark▼; Gabriel▼; Microwave Assoc.▼; Nurad▼; Prodelin; RF Systems; Rhode & Schwarz▼; Terracom▼

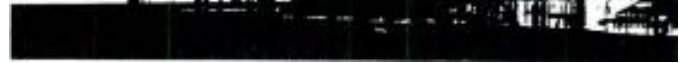

Antennas, TV Alford 1,2; Andrew 1; Blonder-Tongue 1,2; 1. HP; 2. CP
Bogner 1,2▼; Canadian GE 1▼; Cetec 1,2▼; Comark 1,2▼; Electronics M&C 1,2; Harris 1,2▼; Jampro 1,2▼; Marconi▼; Micro Communications 1,2▼; Prodelin 1; RCA 1,2▼; Rohde & Schwarz 1▼; Shively 2▼; Sitco; SWR 1,2▼

Towers Advance Industries▼; Allied Tower; Andrews Tower; E-Z Way▼; Fort Worth; Grasis; Harris▼; High-Lite; Hy-gain▼; Kline; Microflect; Nudd▼; RF Systems; Sitco; Tri-Ex▼; Unarco-Rohn▼; Utility Tower▼; Will-Burt▼

Tower Hardware & Construction Equipment Advance Industries▼; Allied Tower; Andrews Tower; Copperweld; Decca Austin; Gabriel▼; Hy-gain▼; Kline; Kortick; Microflect; Norton; Nudd▼; Pandvit▼; Phil. Resins▼; CN Polites; RF Systems; Sitco; Tri-Ex▼; Unarco-Rohn▼; Utility Tower▼

Tower Lighting Advance Industries▼; Andrews Tower; EG&G▼; Flash Technology▼; Harris▼; Hughey & Phillips; Hy-gain▼; Microflect; Tri-Ex▼; Unarco-Rohn▼; Utility Tower▼

Transmission Line & Connectors Alford; Andrew; Belden; Brand Rex▼; Cablewave▼; CCA▼; Comark▼; Delta▼; Gabriel▼; Harris▼; Micro Communications▼; Moseley▼; Multronics▼; Panduit▼; Phelps Dodge; Prodelin; RCA▼; Rohde & Schwarz▼; Shively▼; Sitco; Soll▼; SWR▼; Utility Tower

Antenna Tuning Units CCA▼; CSP; Harris▼; Jampro▼; Multronics▼

DA Equipment CCA▼; CSP; Delta▼; Gabriel▼; Harris▼; Jampro▼; Multronics▼

VII. MEASURING/MONITORING/TIMING/LOGGING EQUIPMENT

Antenna Monitors Delta▼; Gorman-Redlich▼; Moseley▼; Potomac▼

Clocks, Time Systems Automated Broadcast Controls 1▼; Ben- 1. digital clocks
veronics 1-3,5▼; Boston Sound 1; Broadcast 2. master clocks
Elect. 1,2,4▼; BTX 1,2▼; Bulova 2,3; Caringella; 3. slave clocks
Channelmatic 4; Chrono-Log 1-5▼; Crown; 4. timers
Datametrics 1-3▼; Dyma 2,3,5▼; EEV 1-3▼; 5. time distribution sys.
Electroneering 4; ESE 1-5▼; Harris 2▼; Lauderdale 1,4; Leitch 1-3,5▼; Logitek 4▼; Magna- 1,2,4,5; QSI 1-4▼; Ramko 1,4▼; Recortec 4▼; Sharepoint 4▼; Standard Elect 2,4; Systron Donner 1,5▼; Tape-Athon 4; Tapecaster 2,4; T.A. 4▼; Thalner 1,4; Torpey 1-3; Trve Time 1-3,5▼; United Systems 1,4▼; Vamco 1,4

Chart Recorders B&K▼; Hewlett-Packard▼; UREI▼

Demodulators Coastcom▼; Comark▼; Dynair▼; Philips T&M▼; Rohde & Schwarz▼; Tektronix▼; Telemet▼; Time & Frequency▼; Video Aids▼

continued on page 82

Super Sleuth

The Lenco 300 System/PCO-317 Automatic Sync Changeover Switch instantly detects the failure of any synchronizing signal and immediately switches to an alternate source. Each input is monitored for the level and timing of the sync, blanking, horizontal drive, vertical drive, burst flag and subcarrier signals.

The PCO-317 monitors the outputs of the *generators*, and not the output of the changeover. Therefore, it will either command a switch or prevent one; but it will never attempt to switch to a faulty generator. And you can use it with two of our generators, one of ours and one of yours, or two of yours.

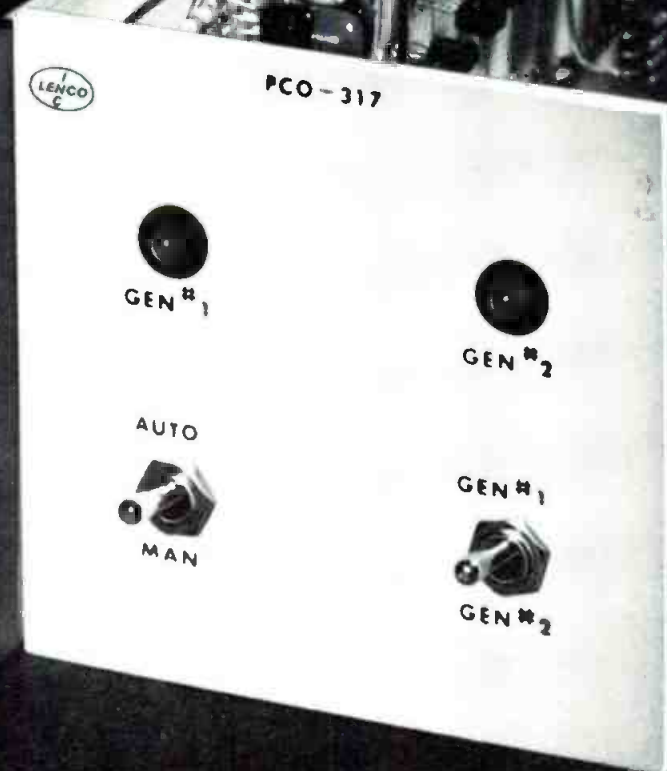

To find out how you can keep a constant check on your sync signals, ask for a Lenco 300 System/PCO-317 demonstration today.

You'll see at a glance why the *professional* switch is to Lenco.



LENCO, INC. ELECTRONICS DIVISION

300 N. Maryland St., Jackson, MO 63755, (314) 243-3147
13620 Littlecrest Dr., Dallas, TX 75234, (214) 241-0976
Post Office Box 301, Atchison, KS 66002, (913) 367-1146
2390 Tiffany Circle, Decatur, GA 30035, (404) 288-2080
Box 4042, Albany, GA 31706, (912) 436-4927
7303 Poplar Lane, Middletown, MD-21769, (301) 371-5588

Source Locator: MEASURING cont.



Field Intensity Meters

1. AM
2. FM
3. TV

Mid-State 2,3; Potomac 1-3; PTS 3; Rohde & Schwarz 1-3; Sadelco 3; Sencore 1-3; Sequerra 2; Time & Frequency 1-3

Frequency Monitors & Counters

Ailtech; Ballantine; Betar; Biddle (JG); Data Precision; Dranetz; EIP; Elcom; Fluke; GAW; Heath; Hewlett-Packard; Hickok; Ivie; Lampkin; Leader; Marconi; McMartin; Mid-State; Nationwide; Philips T&M; Sencore; Systron Donner; Tektronix; Time & Frequency; True Time; United Systems; Wilkinson

Generators, Audio

Amber; American Microsignal; Bald Mountain; B&K; Di-tech; Dyma; Fluke; Frequency Devices; GAW; Heath; Hewlett-Packard; Hickok; Ivie; Leader; Marconi; Monroe; Orban; Philips T&M; Potomac; Quad-Eight; Radiometer; Sencore; Sound Technology; Spectra Sonics; Tektronix; Telonic; UREI; White

Generators, RF

Ailtech; B&K; Boonton; Communication Techniques; Delta; Fluke; Heath; Hewlett-Packard; Hickok; Kay Elemetrics; Marconi; Potomac; Radiometer; Rockland; Sencore; Systron Donner; Telonic; Texscan; Wavetek

Generators, Video

1. multiple output
2. cross pulse only

Broadcast Video 1; Hickok 1; Leader 1; Leitch 1; Marconi 1; NTI 1; Philips T&M 2; Texscan 1; United Systems 1; Video Aids 2

Impedance Bridges

Alford; Biddle (JG); B&K; Boonton; Delta; Delta (Long); Gotham Audio; Heath; Hewlett-Packard; Hickok; Leader; Texscan; Wide Band

Burst Phase Meters

Dranetz; Video Aids

Voltmeters, Multimeters, Etc.

1. voltmeters
2. multimeters
3. dB meters

Amber 3; Audio Technology 3; Bald Mountain 3; Ballantine 1-3; Bayly 1,3; Biddle (JG) 2; B&K 1,3; Boonton 3; BPI 1,3; California Instruments 1,2; Crompton 1,3; Data Precision 1,2; dbx 3; Delta; Dranetz 1,2; Fluke 1-3; GAW 1; Gralex 1; Heath 2; Hewlett-Packard 1,2; Hickok 1,2; International Instruments 1,3; Ivie 1,3; Leader 1,2; MCI 1; Nationwide 1,2; Philips T&M 2; Potomac 3; Sencore 1,2; Sharepoint 3; Systron Donner 1-3; Tektronix 1,2; TM 3; Triplett 1-3; United Systems 1; Weston 1-3

▼ MEANS VERIFIED SOURCE

Harmonic Distortion Meters

Amber; Asaca; B&K; BPI; GAW; Heath; Hewlett-Packard; Ivie; Leader; Marconi; Potomac; Radiometer; Sound Technology

Intermodulation Meters

Amber; Barker & Williamson; B&K; BPI; Crown; Hewlett-Packard; Marconi; Potomac; Sound Technology; TT Electronics

Phase Meters

B&K; Delta; Dranetz; Gorman-Redlich; Hewlett-Packard; Nationwide; Potomac; Video Aids; Wavetek

RF Wattmeters

Bayly; Bird; B&K; Boonton; Dielectric; Electro Controls; Hickok; Micro Communications; Rohde & Schwarz

Multitest Systems

Amber; Fluke; PTS; Systron Donner

Oscilloscopes

Ailtech; Ballantine; B&K; California Instruments; Heath; Hewlett-Packard; Hickok; Hitachi; Leader; Lectrotech; Lenco; Philips T&M; Sencore; Tektronix; Texscan; Ultra Audio; Wavetek

Loggers and Logger Equipment

1. tape loggers
2. log printers

Accurate Sound 1; Broadcast Elect. 1,2; Fluke 1,2; Groton Computer 2; Hallikainen; Hewlett-Packard 2; Kaironics 1; Moseley 2; Potomac 2; QSI 1; Sharepoint 2; Time & Frequency 2

Modulation Monitors

Belar; Boonton; Harris; Hewlett-Packard; Marconi; McMartin; Motorola; QEI; Sequerra; Time & Frequency; Versa-Count; Wilkinson

Sideband Analyzers

Marconi; Rockland; Rohde & Schwarz; Tektronix; Telemet

Spectrum Analyzers

Ailtech; Amber; Eventide; Hammond; Hewlett-Packard; Inovonics; Kay Elemetrics; Marconi; Mid-State; Rockland; Ken Schaffer; Systron Donner; T.A.; Tektronix; Telemet; Texscan; White

Status & Alarm Indicators

BI Elect.; Bird; Caringella; Coastcom; CSI; Dage/MTI; Dyma; Harris; ITI; Lear Siegler; Moseley; Nationwide; Rivers; Sharepoint; Time & Frequency; Trepac; United Systems

Automatic TV Monitors

Dyma; Electra; Lenco; Marconi; Sencore; Time & Frequency

Vectorscopes

Broadcast Video; Electro & Optical; Lectrotech; Lenco; Rohde & Schwarz; Sencore; Tektronix; Video Aids

Video Noise Meters

Asaca; Hewlett-Packard; Lenco; Marconi; Tektronix

Video Test Generators

Broadcast Video; Colorado Video; Corley; Leader; Leitch; Lenco; Marconi; NTI; Philips T&M; Rohde & Schwarz; Tektronix; Telemet; Visual Information; Wavetek

VITS, VIR Systems

Lenco; Rohde & Schwarz; Tektronix; Video Aids

Waveform Monitors & Analyzers

B&K; Broadcast Video; Colorado Video; Electro & Optical; Hewlett-Packard; Hitachi; Lectrotech; Lenco; Rohde & Schwarz; Tektronix; Ultra Audio; World Video

Wow & Flutter Meters

B&K; BPI; Fidelipac; Leader; Philips T&M; Potomac; Radiometer

Diff. Phase/Gain Measurement

Asaca; B&K; Computer Magnetics; Dranetz; Hewlett-Packard; Lenco; Philips T&M; Potomac; Tech. Labs; Tektronix

continued on page 84

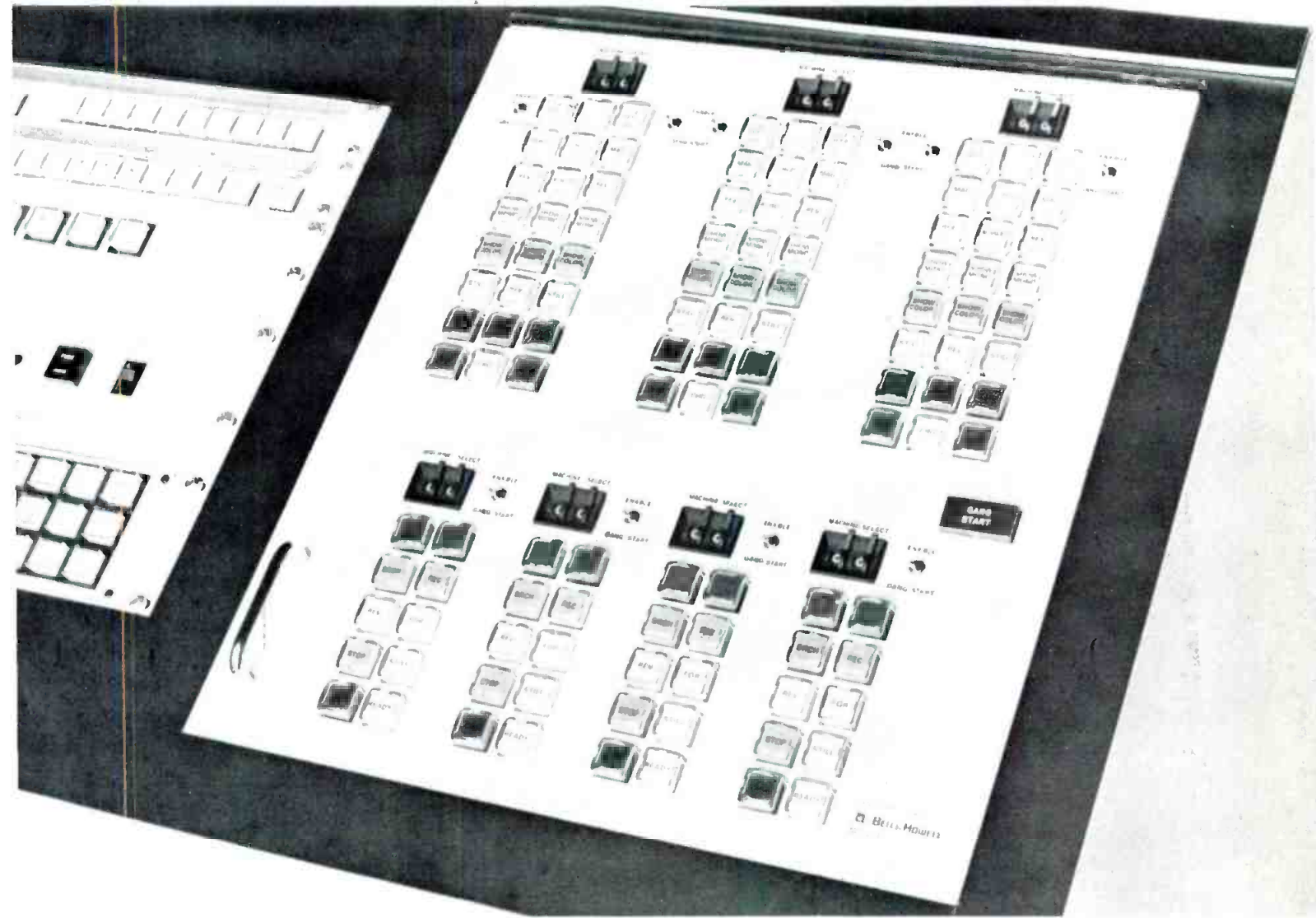

New machine control system cuts installation costs now - reduces downtime later.

If you are about to install new tape machines, remodel your plant, or move into a new facility, now is the time to find out how the new TCS-1 Machine Control System can reduce your material and labor expenses during installation—and streamline your operation for years to come.

The TCS-1 is easy to install because it uses dual twisted pair audio-type wiring, rather than the complex multi-conductor cables normally used with remote controls. Through the use of microprocessors, the TCS-1 can use these twisted pair connections to operate up to 100 VTR's and/or film chains.

But aside from easy installation, there are some significant technical advantages to the TCS-1. For example, the system includes provisions for assigning specific machines to specific control panels, eliminating the possibility of conflicting or unauthorized control commands reaching the same machine from different control stations. And, by spreading the ma-

chine control data over as many as eight buses, the TCS-1 is able to send and receive data more quickly than systems in which all data must be funneled through a single bus.

System redundancy is another advantage of the TCS-1. If one of the control buses should fail, there are still seven others. And, since identical microprocessors are used throughout the system, any one of them can be replaced with any of the others—just change out the board, plug in a spare memory chip, and you're back on line.

For system control, the TCS-1 uses a modular, building-block approach which allows you to determine the size, shape, color, and function of your control panels. Just tell us what you need and we'll build it!

For more information about the new software-based TCS-1 Machine Control System, write or call TeleMation Division, P.O. Box 15068, Salt Lake City, Utah 84115, (801) 972-8000.

TELEMATION DIVISION

 BELL & HOWELL

©1979 Bell & Howell Company. All rights reserved. TeleMation and Bell & Howell are trademarks of Bell & Howell Company.

Circle 148 on Reader Service Card

Source Locator

VIII. SERVICES

Computer Business Services 1. broadcasting, radio 2. broadcasting, TV	Automated Business Concepts 1▼; Automation Elec. 1▼; Bloomington 1▼; Boston Sound 1; Columbine Systems 1,2▼; Computer Business Systems 1; Cox Data 2▼; Data Communications 1,2; Croton Computer 1▼; Jefferson Data 1,2▼; Kaman 1,2▼; PWH 1,2; Station Business 1,2▼
Equipment Rental Services 1. production equipment 2. post production service	Accurate Sound 1,2▼; AF Associates 1▼; All Mobile 1,2; Avonix 1,2▼; BAA 1; Bardwell & McAlister 1,2▼; Broadcast Services 1; Birns & Sawyer 1,2▼; Camera Mart 1▼; Columbia Video 1,2▼; Compact Video 1,2▼; Comquip 1,2▼; Conrac East 1,2▼; Dyma 1▼; F&B Ceco 1▼; General TV 1,2▼; Alan Gordon 1▼; Image Devices 1▼; Landy 1; Leasametric 1▼; Lebow 1▼; Legal Tapes 2▼; Media Concepts 1,2▼; MPCS 1,2▼; Power-Optics 1; RCA 1▼; Sawyer Camera 2▼; System Associates 1▼; Technisphere 1,2▼; Tele-Cine 1▼; Tele-Measurements 1; Television Productions 1; Tri-Tronics 1,2; Video Production 1,2; Vidtronic 2
Studio Design 1. radio 2. TV	Stanley Ash 2; Avonix 2▼; BAA 1; Cat Construction 1,2; Centrol 1,2▼; Cetec 1▼; Columbia Video 2▼; Comark 2▼; Compact Video 2▼; Delta (Long) 1,2; Dyma 1,2▼; Electro & Optical 2▼; Image Devices 2▼; Imero Fiorentino 2▼; Fisher-Burke 1▼; General TV 2▼; Grinnan; Lauderdale 1; Lebow 1,2▼; Long 1,2; Lumitrol 2▼; McCurdy 1▼; MPCS 2▼; Peirce-Phelps 2; RCA Service 2▼; Rosner TV Systems 1,2▼; Sawyer Camera 2▼; Sharepoint 1▼; Soll 1,2▼; Tele-Measurements 2; Tri-Tronics 1,2; Ultra Audio 1,2▼
Videotape/Film Recording & Transfer	Bonneville▼; Columbia Video▼; Compact Video▼; DAK; General TV▼; Goldmark; Image Transform▼; Interface Video▼; Legal Tapes▼; Media Concepts▼; MPCS▼; Palmer▼; RCA Service▼; Tri-Tronics; Warren Smith▼; Videotape Co.▼; Vidtronic

IX. COMPONENTS/ HARDWARE

Batteries	Alexander▼; Arriflex▼; Birns & Sawyer▼; Christie▼; Cine 60▼; Cinema Products▼; Frezzolini▼; Globe Union; Gould; Multiplier▼; Television Products▼; Yardney▼
Battery Chargers	Christie▼; Cine 60▼; Cinema Products▼; Frezzolini▼; Globe Union; Gould; North Wind; Television Products▼
Cabinets, Enclosures, Shipping Cases 1. racks 2. cabinets 3. shipping cases	Bayly 1,2▼; Broadcast Elect. 1,2▼; Amco 1,2; Anvil 1-3▼; BSC 2; Cases 1-3▼; Dyma 1,2▼; Emcor 1,2▼; Enclosure 1,2; Grinnan 1,2; Gruber▼; Hammond 1; K&H 3▼; Kandit 3; McCurdy 1,2▼; Multiplier 3▼; Neumade 1-3▼; Plastic Reel 1-3▼; Optima 1,2; Quad-Eight 1,2▼; Rusland 1,2▼; Stachtron 1,2▼; Storeel 1,2▼; Thermodyne 1,3▼; Winsted 1,2▼
Connectors	ADC; American Technology▼; Andrew; AVA Elec.; Boston Insulated▼; Cablewave▼; Daburn▼; GBC; Kings▼; Pyramid; RMS; SGL Waber; Switchcraft▼; SWR▼; Trompeter▼; Whirlwind

▼ MEANS VERIFIED SOURCE

Hum Bucking Coils	ADC; Audio Video Engineering▼; Intl. Nuclear▼; North Hills▼; PTS▼; TeleMation▼; Video Aids▼
RF Tubes	Amperex▼; Bayly▼; Calvert▼; Ceco▼; Econeo▼; EEV▼; Eimac▼; Levit▼; NEC▼; RCA Dist.▼; RCA E-O▼; Thor; Varian▼
Vacuum Tubes	Amperex▼; Bayly▼; Ceco▼; EEV▼; Freeland▼; Image Transform▼; Intl. Rectifier; Levit▼; RCA Dist.▼; Vacuum Tube▼; Varian▼; VIF▼; Westinghouse▼
Camera Pick-Up Tubes	Amperex▼; Bayly▼; Calvert▼; EEV▼; Hitachi▼; Levit▼; RCA Dist.▼; RCA E-O▼
Rectifiers	Amperex▼; Bayly▼; Calvert▼; Delta▼; EEV▼; Intl. Rectifier; Levit▼; Thor; Topaz; Westinghouse▼; Wilkinson
Surge Protectors	Bayly▼; Comsonics; Delta▼; Dyma▼; EEV▼; Intl. Rectifier; Lightning Elimination▼; MCG; Multiplier▼; Sawyer Industries; Siemens; Topaz; Transtector; Wilkinson
Wire & Cable	Alpha Wire▼; Belden▼; Boston Insulated▼; Brand Rex▼; Copperweld▼; Daburn▼; Gotham Audio▼; Ideal; ITT Suprenant▼; Mohawk; Pace; Pyramid; SWR▼; Times; Trompeter▼; Whirlwind
RF Inductors	CSP; Multronics▼; North Hills▼; PTS▼
Transformers	ADC; Burns Audiotronics▼; Crompton▼; Decca Austin; Delta▼; ITI▼; Lear Siegler; Long; Microtran▼; North Hills▼; Wide Band▼
Quartz Crystals	Comet▼; Eidson▼; ITT Jennings▼
Vacuum Capacitors, Capacitors	EEV▼; Johanson; Seacor▼; Surcom▼
Tools	Alpha Wire▼; Cooper Group; Daburn▼; Ideal; Instrument Labs; PTS▼; Ripley

X. SYSTEMS

Power/Generator Systems	Advance Conversion; Alexander▼; Bayly▼; Cat; Compact Video▼; Gould; High-Lite; J&D; N.A. Turbine; North Wind; Onan; Sawyer Industries; Soll▼; Teledyne Energy; Topaz
Mobile Van Construction	AF Associates▼; Applied Video; Atlantic Research; Cat; Caterpillar; Centro▼; Compact Video▼; Dyma▼; Electro & Optical▼; E-N-G▼; Grinnan; Harris▼; High-Lite; Rosner TV Systems▼; Soll▼; Tele-Measurements; Valad; Whirlwind; Wolf Coach▼
Facility Turnkey Installation	AF Associates▼; Applied Video; Atlantic Research; BAA; Canadian GE▼; Cat; Compact Video▼; DBC▼; Delta (Long); Dyma▼; Elcom▼; Electro & Optical▼; Gabriel▼; Grinnan; Harris▼; Long; Northeast Broadcast; Nurad▼; RF Systems; Rosner TV Systems▼; Soll▼; Tri-Tronics; VIF▼; Winegard
Weather Systems	Alden; Arvin/Echo▼; Cat; Enterprise; Technology Service▼; Texas Elect.;
EBS Two-Tone Systems	Elcom▼; Fixtune▼; GAW; Gorman-Redlich▼; Intl. Nuclear▼; Logitek▼; Rivers



fact: the SC39 Series meets all the unique demands of professional cartridge users

- Broadcasting
- Recording
- Disco
- Transcription and other professional uses

The Professional Challenge: Undistorted playback, even of the toughest-to-track, "hottest" recordings.

The SC39 Solution: The Shure-designed shank structure and bearing assembly gives trackability up to and beyond the theoretical cutting velocities of today's recordings. Frequency response is essentially flat across the audio spectrum, optimized for professional applications.

The Professional Challenge: Day-in, day-out rigors of slip-cuing, backcuing, and the inevitable stylus abuse that comes with the job.

The SC39 Solution: The internal support wire and special elastomer bearing insure stable and accurate backcuing without groove jumping. This, plus the following exclusive features, protect the SC39 from accidental stylus damage:

SIDE-GUARD Stylus Deflector

A unique lateral deflection assembly prevents the most common stylus damage by withdrawing the entire stylus shank and tip safely into the stylus housing before it can be bent.

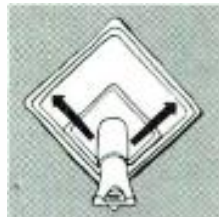

FLIP-DOWN Locking Stylus Guard

The exclusive lever-operated, locking stylus guard gives the stylus tip positive protection when not in use. With the flip of a lever, it snaps out of the way, and positions a highly visible cueing aid.

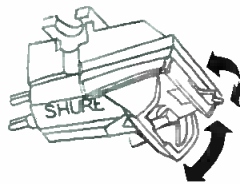

The Professional Challenge: Prolonged record (and lacquer master) playability without objectionable noise buildup.

The SC39 Solution: A unique Shure MĀSAR™ stylus tip is designed to minimize noise and cue-burn on records. Tests on lacquer masters show that the noise level on a record played repeatedly with an unworn Shure MĀSAR tip is significantly below that of a similar disc played with an unworn conventional stylus. The SC39 also reduces noise buildup on 45 rpm records made from reprocessed or substandard vinyl.



The Professional Challenge: A multiplicity of different applications, which no one cartridge can satisfy.

The SC39 Solution: The SC39 Series consists of the following three cartridges, for every professional and high fidelity application:

Cartridge	Stylus tip	Tracking force	Applications
SC39ED	Biradial (Elliptical)	3/4—1-1/2 grams	High fidelity applications where light tracking forces are a consideration. Transcription, recording lab playback of lacquer masters, high quality broadcast.
SC39EJ	Biradial (Elliptical)	1-1/2—3 grams	Applications where heavier tracking forces are required. AM broadcast, disco.
SC39B	Spherical		

The SC39 Series Professional Phono Cartridges



Shure Brothers Inc., 222 Hartrey Ave., Evanston, IL 60204
In Canada: A. C. Simmonds & Sons Limited
Manufacturers of high fidelity components, microphones,
sound systems and related circuitry.

Circle 149 on Reader Service Card

SAVE 30% TODAY...

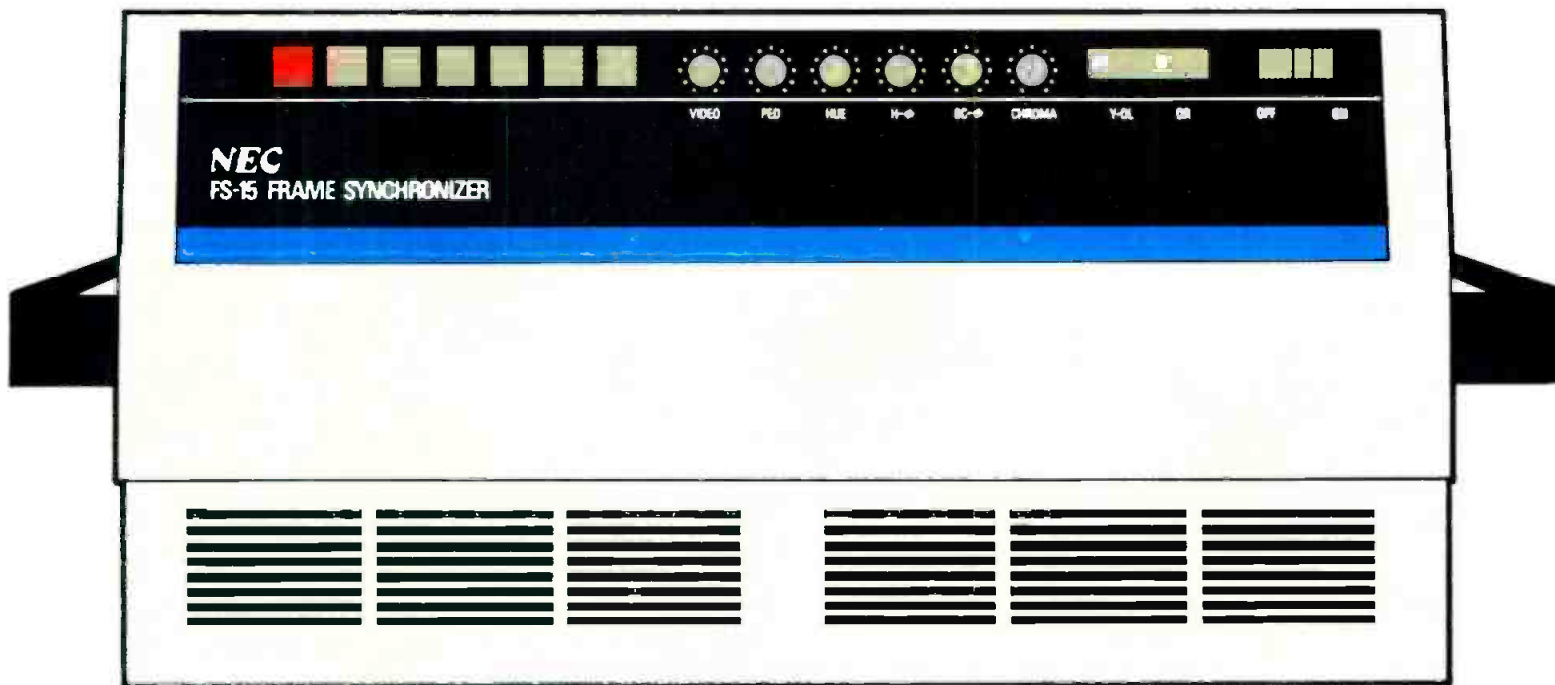

Save 30% on NEC's FS-15 Frame Synchronizer

This is not a "limited time only" come-on. Our new regular price is 30% lower than ever before.

Thanks to market popularity, we can now mass-produce the FS-15, using advanced assembly line techniques. Efficiency is up. Costs are down. Especially on the heart of the FS-15, the NEC 16K RAM Memory.

And at NEC, our long-standing policy is to pass cost savings on to our customers.

This new lower price applies to the frame synchronizer family that won the 1975 Emmy Award for outstanding engineering excellence... a compact, energy-efficient package designed to provide full-frame storage for instantaneous synchronization of remote to local signals.

Features:

The FS-15 is the first frame synchronizer to use 16K RAM Memory Chips—the ultimate system for operational stability. Unique data rotation control allows the user to continue on air while covering a memory failure within a few seconds. The FS-15 built-in memory analyzer pinpoints the defective component in less than a minute. Additional service is assured by internal provision for direct connection of the A to D converter to the D to A converter.

Also built-in: a sync generator providing H, V, Flag, Subcarrier and Sync Blanking pulses... bypass capability... RG-59 cable equalizer (up to 800 ft.)... plus a special differential input circuit that eliminates common mode hum from remote lines.

And except for the input and output video amplifiers, everything is digitized: all sync signals, including blanking and burst, and all options, including TBC, Freeze Frame/Field and Velcomp. You get a stability that's just plain impossible with analog units.

The FS-15 is a lot of synchronizer for the money. But price isn't the only economy. NEC's FS-15 family "building block" design lets you buy only as much capability as you now need. Later, to expand your system, add any of the modular options shown on the next page. They'll let you create just about any production effect you can think of.

WARRANTY

NEC warrants its products to be free from defects for a period of one year from delivery including parts and labor. For complete details contact NEC America, Incorporated, Broadcast Equipment Division.

24-Hour Service Hotline
800-323-6656
In Illinois call 312-640-3792

Circle 150 on Reader Service Card

www.americanradiohistory.com

BUILD TOMORROW

**DVP-15
Digital Video Processing**



Permits computer manipulation of the FS-15 Frame Memory to create unlimited special effects: zooms, compression, mirror, optional split mode and chromakey tracking. A new NEC Stand-Alone Control Panel permits complete switcher independent use of DVE.

FS-15-FE

Correct V and H blanking violations in 1 to 8% steps. Upgrade to full Digital Video Effects with 4 plug-in modules.

FS-15

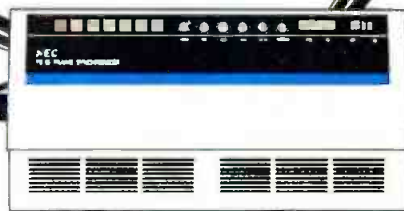

Freeze Frame

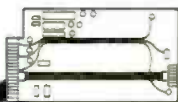

TBC

Remote Control Panel

Provides full control of the FS-15 functions and standard options from a remote location.

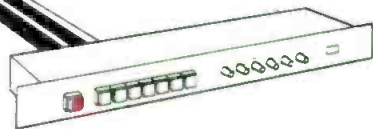

Digital Strobe Action*

Allows you to maintain a record of motion at multiple points in a TV picture and to decay the images for slow-motion follow effect.

* TRADEMARK PENDING

Stand-Alone Control Panel

**TNR-15A/15D
Noise Reducer**

A digital process that dramatically improves the signal-to-noise ratio of pictures up to 15db either stand alone or as an add-on to the FS-15.

Split Card

Multi-Freeze

Lets you compress and freeze 4, 9, or 16 complete images on a single raster, multiple scenes or continuous sequence.

Demo-Tape Available

(in the U.S.A. only)

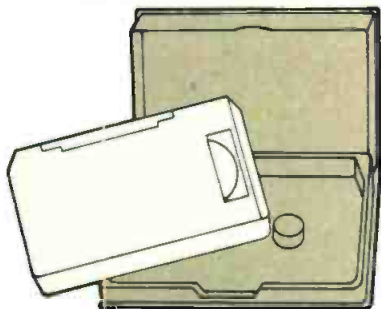

Nippon Electric Co., Ltd.
NEC America, Inc.
Broadcast Equipment Division
130 Martin Lane
Elk Grove Village, Illinois 60007

(clip along dotted line)

Gentlemen:

- Please send me full details about the FS-15 and options.
- Please ask your representative to phone me for an appointment.
- Please send me a Demo-Tape.

Name _____

Title _____

Company _____

Address _____

City _____ State _____ Zip _____

Phone _____



ST1910/1911 Spectrum Translator

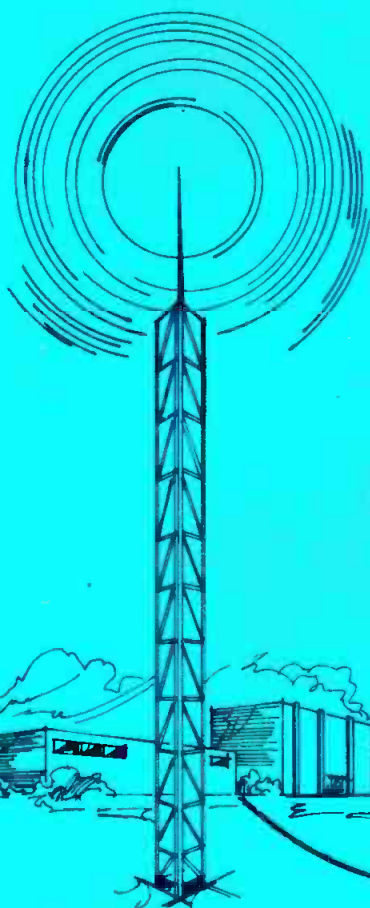

- Extends the low frequency spectrum of standard, voice-grade telephone facilities by 240Hz, delivering the added punch needed by the broadcaster at minimum cost.
- Provides a gain of over two octaves in frequency response normally lost due to the bandwidth-limiting of telephone facilities.
- Easily connected to existing circuits.
- Simple, easy to operate, two-unit system consisting of a transmitter, which translates the spectrum of 60-2760 Hz up to 300-3000 Hz for transmission and a receiver which recovers the original signal after reception.
- Lightweight, portable transmitter and receiver are housed in rugged, molded ABS plastic cases equipped with a convenient handle/stand.
- Low distortion, low noise, fully protected input and output circuits.
- Capable of providing bandwidth up to 5kHz where permitted by transmission facilities.



McCURDY RADIO INDUSTRIES

TORONTO (416) 751-6262 • TELEX 06-963533
CHICAGO (312) 640-7077 • TWX 910-222-0436
NEW YORK (201) 327-0750 • TWX 710-988-2254

Circle 151 on Reader Service Card

www.americanradiohistory.com

EQUIPMENT MANUFACTURERS

Listed below, in alphabetical order, are hundreds of manufacturers of products for the broadcast industry, and companies supplying services such as studio and mobile facility construction, lens repairing, consulting, etc. The information is based on the manufacturers' responses to an extensive questionnaire. In addition, those manufacturers who supplied product literature with the responses have been verified as regular suppliers of the products and services listed; a "VS" symbol (Verified Source) appears after the listing. Also included for some companies is a list of field office addresses and telephone numbers directly following the main product listing. New this year, as an extra service to readers seeking more information, is the appearance of advertisers' names in red, cross-referenced to the page on which their ad appears and to our list of independent broadcast reps and distributors when applicable. Also included in this section are some exclusive nationwide distributors of certain brands (which appear in parentheses after the product description).

A

ACCURATE SOUND CORP

114 5th Ave Redwood City CA 94063
415 365-2843

Mic booms & dollies; open reel player/recorders; replacement & rebuilt tape heads; tape duplicators; production equip rental; complete audio studio construction; tape loggers; post-production service VS

ACHRO-VIDEO LTD

10 Virginia Ave West Nyack NY 10994
914 358-5504

TV lens repair service

ACOUSTIC RESEARCH

10 American Dr Norwood MA 02062
617 769-4200

Speakers; monitor amps VS

ACRODYNE INDUSTRIES INC

21 Commerce Dr Montgomeryville PA 18936
800 523-2596

TV transmitters & translators; RF amps; TV exciters VS

ADC PRODUCTS

4900 W 78 St Minneapolis MN 55435
612 835-6800

Patch panels, connectors, hum bucking coils, transformers

ADDA CORP

1671 Dell Ave Campbell CA 95008
408 379-1500

Digital frame stores, electronic still stores, frame synchronizers VS

See ad pgs 23, 101—refer to rep/dist section

CA	ADDA Corp 10100 Santa Monica Blvd Ste 2500 Los Angeles 90067	213 557-2550
GA	ADDA Corp 2693 Twigg Circle Marietta 30067	404 953-1500
NJ	ADDA Corp 1 S Colonial Ridge Morsetown 08057	609 234-4426

ADERHOLD CONSTRUCTION CO

3384 Peachtree Rd NE Atlanta GA 30326
404 233-5413

TV and radio facility construction

ADVANCE CONVERSION DEVICES CO

109 Eighth St Passaic NJ 07055
201 778-0707

Emergency power supply, uninterruptible power systems, inverters

ADVANCE INDUSTRIES INC

2301 Bridgeport Dr Sioux City IA 51102
712 252-4101

Antenna towers, tower hardware and lighting

ADVENT CORP

195 Albany St Cambridge MA 02139
617 661-9500

Speakers, audio delay lines, large screen video projectors

AEL COMMUNICATIONS CORP

PO Box 507 Lansdale PA 19446
215 822-2929

Connectors, passive distribution accessories.

AF ASSOCIATES INC

100 Stonehurst Court Northvale NJ 07647
201 767-1000

VTR rebuilding, mobile van construction, facility turnkey installations, production equip rentals, color framer editing aid device, gated video circuits VS

AGFA-GEVAERT INC

275 North St Teterboro NJ 07608
201 288-4100

Open-reel & cassette audio tape; mag film; test tapes; video tape; film VS

AIC PHOTO INC (ALLIED IMPEX CORP)

168 Glen Cove Road Carle Place NY 11514
516 742-7300

Lenses; film and TV (Soligor); film cameras and accessories (Bauer), film processors (JOB0)

AILTECH (A CUTLER HAMMER CO)

19535 E Walnut Dr City of Industry CA 91748
213 965-4911

Los Angeles Operations
5340 Alla Rd Los Angeles CA 90066
213 822-3061

RF attenuators; frequency monitors & counters;

spectrum analyzers; power amps; RF generators; microwave antennas; oscilloscopes VS

AITKEN COMMUNICATIONS INC

214 Harrison St Taft CA 93268
805 765-5403

Automation programmer, monitor amps; active filters; time insertion sequencers; memory units; complete automation systems VS

VS MEANS IT'S VERIFIED

AKG ACOUSTICS DIV PHILIPS AUDIO VIDEO SYSTEMS

91 McKee Dr Mahwah NJ 07430
201 529-3800

Reverb units; stereo pickups; headphones; mics (dynamic, condenser, wireless, shotgun, lavalier); mic booms & dollies, accessories VS

AKG SALES DIV CANADA PHILIPS

105-200 Consumers Rd #105 Willowdale Ont
M2J 4R4

416 494-1453

Reverb units; stereo pickups; headphones; mics (dynamic, condenser, wireless, shotgun, lavalier); mic booms and dollies, accessories VS

AKAI AMERICA LTD

2139 E Del Amo Blvd Compton CA 90220
213 537-3880

Portable video cameras

ALCO PRODUCTS INC

1551 Osgood St No Andover MA 01845
617 685-4371

Machined aluminum knobs

ALDEN ELECTRONIC & IMPULSE RECORDING EQUIP CO INC

1 Washington St Westboro MA 01581
617 366-8551

Fax recording systems; weather data systems, satellite earth station receivers; analogue & digital facsimile weather chart scanners & recorders; remote weather radar recorders; weather satellite picture receiving systems, marine radiofacsimile weather chart recorders; facsimile communications equip



HBU-4400



You don't need a "gorilla" to carry the portable HBU-4400. It weighs only 22 lbs. without the battery and provides 10 full minutes of recording time per cassette. Cassettes are preferred for portable applications because you don't have to monkey around with reel-to-reel tape. High band "quad"

quality is achieved by tripling the head-to-tape speed of the U-format recorder and adding Recortec electronics to a transport with proven interchangeability. For reliability reasons the capstan and scanner speed increase is achieved without any change in motor rpm and, of course, all bearings are still well within their design limits. And when you need a studio machine for playback and editing there is the HBU-2860 that will faithfully reproduce your high quality HBU tapes. We kept the 2860 remote control interface unchanged so it can work

HBU-2860



with your computerized editing system.

The HBU format is economical to own and economical to use. The HBU costs less than a third of machines of other formats with the same video quality. Tape costs are lower too. **CONCLUSION:** Buy the HBU and donate your "gorilla" to the zoo.

Other products from Recortec are: Video Tape Conditioners and Video Tape Evaluators for all tape widths, Video Cassette Evaluators, Video Tape Timers and Reel Servo Modifications (R-MODs) for quad recorders and Video Tape Addressors which record time code on two-inch tape at high speed.

Circle 152 on Reader Service Card

RECORDER
 7777...
SUNNYVALE, CA 94086
PHONE (408) 735-8821

The Source '79

ALEXANDER MFG CO

PO Box 1645 Mason City IA 50401
515 423-8963

Batteries, portable power packs, emergency power equip VS

See ad pg 104—refer to rep dist section

FL Alexander 409 SE 28th Ave PO Box
1053 Pompano Beach 33061 305 781-1181
IL Alexander 425 S Elm St Palatine
60067 312 359-1153
NJ Alexander NE 47 Lenape Dr
Montville 07045 201 263-1888

ALFORD MFG CO

15 Sixth Rd Woburn MA 01801
617 935-8610

Antennas, FM, TV, microwave; diplexers, RF loads; microwave units; transmission line & line accessories; impedance bridges

ALLIED BROADCAST EQUIP

635 SE St Richmond IN 47374
317 962-8596

Audio dist amps, pre-amps; studio cabinets & furniture VS

ALL MOBILE VIDEO INC

630 9 Ave New York NY 10036
212 757-8919

Equip rental services; post production services

ALLIED TOWER CO

PO Box 331 South Houston TX 77587
713 946-9546

Antenna towers & accessories; tower design, construction, erection

ALLISON RESEARCH INC

2817 Erica Place PO Box 40288 Nashville TN
37204

615 255-4766
Limiter/compressor, console programmers

ALPHA WIRE CORP

711 Lidgerwood Ave Elizabeth NJ 07207
201 925-8000

Cable, wire; tools VS

ALTEC LANSING SOUND PRODUCTS DIV

1515 S Manchester Ave Anaheim CA 92803
714 774-2900

Audio dist, line, monitor, power, PA amps; pre-amps; ALC & AGC amps; audio delay lines; equalizers and filters (passive and active); audio mixers; dynamic, lavalier & condenser mics; speakers; tone generators; patch panels; intercom systems; VU meters; audio connectors VS

See ad pg 147

VS MEANS IT'S VERIFIED

AMBER ELECTRO DESIGN LTD

4810 Jean Talon West Montreal Canada H4P 2N5
514 735-4105

Multipurpose audio test set, audio spectrum analyzers, audio generators, dB meters, intermodulation meters; harmonic distortion meters
See ad pg 185 VS

AMCO ENGINEERING CO

7333 W Ainslie St Chicago IL 60656
312 867-8500

Racks, cabinets, enclosures

AMERICAN DATA

401 Wynn Dr NW Huntsville AL 35805
205 837-5180

Production switchers large & small; MC switchers, post-production switchers; automated master control; routing switches; SEGs; video delay lines; audio line, distribution, and monitor amps; chroma keyers; video pulse, distribution and subcarrier amps VS

See ad pg 34

CA D Cadora 3760 Cahuenga Blvd
N Hollywood 91604 213 760-3221
CT B Munzner PO Box 452
New Hartford 06057 203 379-7840
GA J Ryan 2219 Oakwana Atlanta
30345 404 633-2100
IN J Gardner PO Box 27324
Indianapolis 46227 317 784-3000
MN K Emmons 10700 Lyndale Ave
S Minneapolis 55420 612 881-1118
MD D Wilcox 5504 Waterway Rockville
20853 301 460-1454

AMERICAN LASER SYSTEMS INC

106 James Fowler Rd Goleta CA 93017
805 967-0423

Infrared video transmission systems; remote control systems VS

AMERICAN MICROSIGNAL CORP

8431 Monroe Ave Stanton CA 90680
714 761-1222

Tone generators, encoders & decoders; land mobile communications systems

AMERICAN MODEM CORP

160 Wilbur Pl Bohemia NY 11716
516 567-7887

Satellite, microwave & industrial data modems

AMERICAN TECHNOLOGY CO INC

PO Box 23169
Phoenix AZ 85063
602 272-9415

Coaxial connectors

AMILON CORP

49-12 30th Ave Woodside NY 11377
212 274-1794

Audio cart & cassette transport mechanisms VS

AMPEREX ELECTRONIC CORP

Providence Pike Slatersville RI 02876
401 762-3800

RF tubes; vacuum tubes; camera pickup tubes; rectifiers VS

See ad pg 32-33

CA Ampex 3040 Scott Blvd Santa Clara
95050 408 249-1134
GA Ampex 3300 N E Expwy Ste 1G
Atlanta 30341 404 458-2519
IL Ampex 175 Scott St Elk Grove Village
60007 312 640-2544
NY Ampex Hicksville Div 230 Duffy Ave Hicksville
11802 516 931-6200
TX Ampex 13773 N Central Expwy Ste 1228
Dallas 75243 214 231-3481

AMPEX CORP

401 Broadway Redwood City Ca 94063
415 367-2011

Audio delay lines; magnetic tape (open-reel, cartridge, cassette, test tapes); portable & studio open-reel player/recorders; tape heads replaced & rebuilt; manual & open-reel audio tape editing systems & accessories; TV studio cameras; studio/field convertible cameras; ENG/EFP cameras; large & small production switchers (Duca-Richardson); TBCs; new videotape (all formats); quad and one-inch helical VTRs; VTR head refurbishing; quad cartridge/cassette player/recorders, automation controls; two VTR editor-controllers, computer-assisted editor; time code generator/readers; audio/video synchronizers; electronic still stores VS

See ad pg 48

Ampex is also exclusive distributor of EECO products (see listing)

CA Ampex 500 Rodier Dr Glendale
91201 213 240-5000
GA Ampex 3135 Chestnut Dr Suite 101
Atlanta 30340 404 451-7112
IL Ampex 2201 Lunt Ave Elk Grove Village
60007 312 593-6000
MD Ampex 10215 Fernwood Rd Bethesda
20034 301 530-8800
NJ Ampex 75 Commerce Way Hackensack
07601 201 489-7400
OH Ampex 4130 Linden Ave Dayton
45432 513 254-6101
TX Ampex 1615 Prudential Dr Dallas
75235 214 637-5100
UT Ampex 2880 S Main St Ste 111
Salt Lake City 84115 801 487-8181

AMPRO/SCULLY

826 Newtown/Yardley Rd Newtown PA 18940
215 968-9000

Scully reel to reel tape recorders; audio consoles & mixers; multicart machines; Scully recording instruments VS

See ad pg 94

AMTRON CORP

5620 Freedom Blvd Aptos CA 95003
408 688-4445

Color portable dc monitors VS

ANDERS INC

77 Wolcott Rd Simsbury CT 06070
203 658-7666

Video delay lines and modules

ANDREW CORP

10500 W 153rd St Orland Park IL 60462
312 349-3300

Earth station antennas; antennas, TV & microwave; transmission line & line connectors; general connectors

ANDREWS TOWER INC

1420 Layton Ave Ft Worth TX 76117
817 831-1222

AM antennas; antenna towers, tower accessories; tower lighting

ANGENIEUX CORP OF AMERICA

1500 Ocean Ave Bohemia NY 11716
516 567-1800

Full line TV & cine lenses & accessories; lens repairing VS

ANIXTER-MARK

2180 S Wolf Rd Des Plaines IL 60018
312 298-9420

Microwave antennas & accessories; point to point antennas, two way antennas



The Source '79

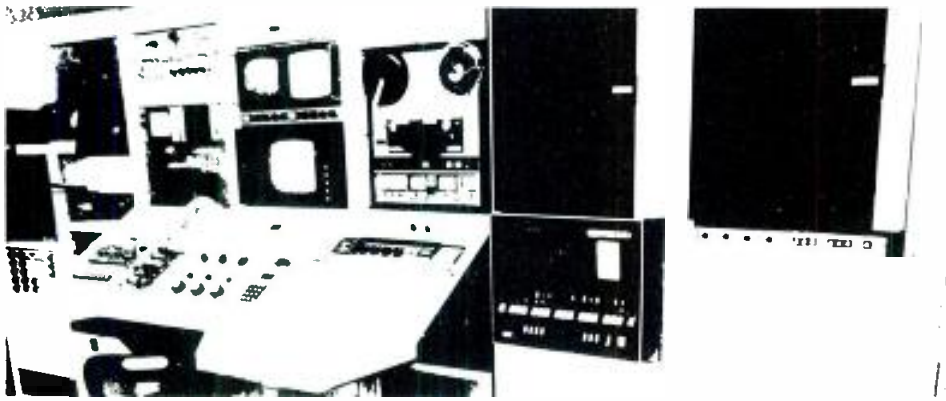

Broadcast media teams must be ready at a moment's notice. With Christie's integrated system; the REFLEX® 20 Charger and sempiternal ni-cad battery packs, there is virtually no wait. Recharge? The fastest in the industry. 12 to 20 minutes and you're completely charged.

Because of the revolutionary "burping" system the batteries remain cool, their cycle life is extended up to 10 times that of conventional ni-cads and 50 times that of other rechargeable batteries.

The Christie System . . . reliable, effective and 90-97% efficient.



50 years experience plus REFLEX® 20 makes you: CHRISTIE-READY.

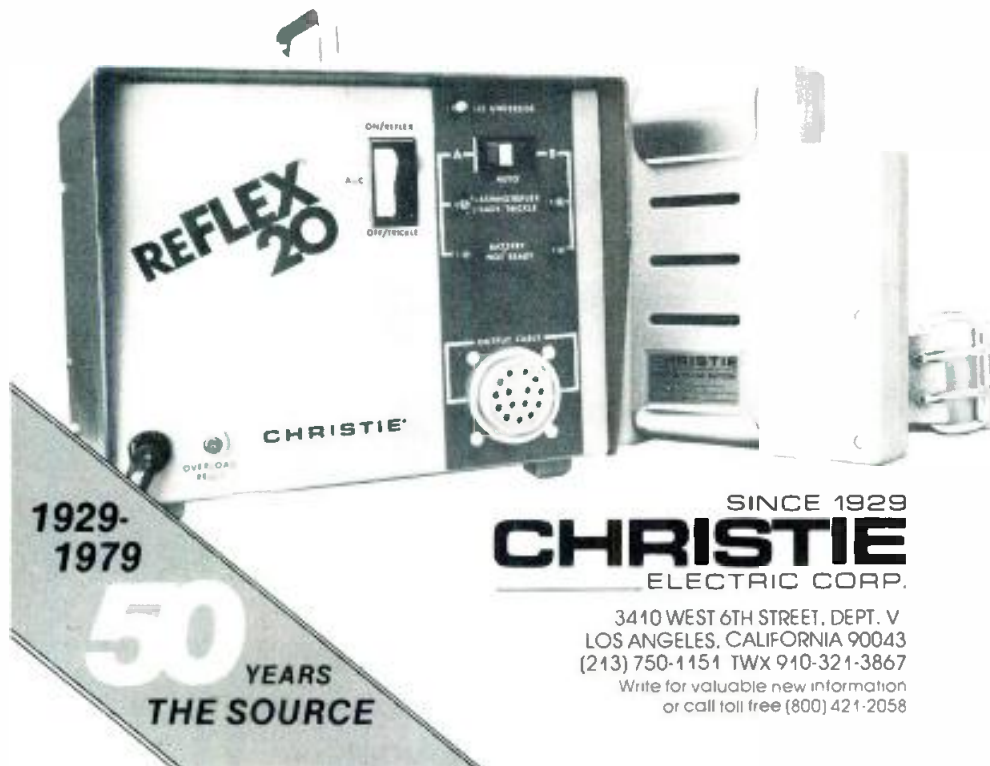

1929-
1979

50 YEARS
THE SOURCE

SINCE 1929
CHRISTIE
ELECTRIC CORP.

3410 WEST 6TH STREET, DEPT. V
LOS ANGELES, CALIFORNIA 90043
(213) 750-1151 TWX 910-321-3867

Write for valuable new information
or call toll free (800) 421-2058

Circle 153 on Reader Service Card

ANN ARBOR TERMINALS INC
6175 Jackson Rd Ann Arbor MI 48103
313 663-8000
Display & terminal CRT equip; alphanumeric generators VS

R.B. ANNIS CO
1101 N Delaware St Indianapolis IN 46202
317 637-9282
Demagnetizing kits, magnetometers; head degaussers VS

ANVIL CASES
4128 Temple City Blvd Rosemead CA 91770
213 575-8614
Racks, cabinets, shipping cases & transit cases VS

ANTENNAS FOR COMMUNICATIONS INC
Silver Springs Shores Industrial Pk 486 Cypress Rd Ocala FL 32670
904 687-4121
Microwave antennas; earth station antennas VS

AP CIRCUIT CORP
865 West End Ave New York NY 10025
212 222-0876
Equalizers, filters (active)

APPLIED VIDEO ELECTRONICS INC
PO Box 25 Brunswick OH 44212
216 225-4443
Video pulse, subcarrier, & distribution amps, VTR rebuilding; mobile van construction, facility turnkey installation

ARISTOCART DIV OF WESTERN BROADCASTING LTD
1960-505 Burrard St Vancouver BC V7X 1M6
604 687-2844
Tape cartridges, test tapes; cartridge racks VS
See ad pg 190—refer to rep/dist section

ARP INSTRUMENTS INC
45 Hartwell Ave Lexington MA 02173
617 861-6000
Music synthesizers, portable; audio processors

ARRIFLEX CORP OF AMERICA
1 Westchester Pl Elmsford NY 10523
914 592-8510
16mm & 35mm cine cameras; camera lenses; tripods & accessories; batteries VS

ARVIN/ECHO SCIENCE — See Echo Science

ASACA CORP OF AMERICA
1289 Rand Rd Des Plaines IL 60016
312 298-4380
Studio/field convertible cameras; ENG/EFP cameras; picture monitors (b&w, color, DC portable); image enhancers; small production switchers; sync & color bar generator systems; quad VTRs; SEGs; harmonic distortion meters; video noise meters; diff phase-gain measurement VS
See ad pg 19—refer to rep/dist section

CA	R Reilly 155-B San Lazaro Ave Sunnyvale 94086.....	408 735-7350
NH	C Miller PO Box 333 Londonderry 03053.....	603 434-0890

VS MEANS IT'S VERIFIED

STANLEY ASH THEATRICAL DECORATORS
101 St Regis Circle S Downsview Toronto Ont M3J 1Y6 Canada
416 633-5182
TV studio design; manual, automated, & dimmer pack light control systems; patch terminals; seamless materials VS

ASHLY AUDIO
1099 Jay St Rochester NY 14611
716 328-9560
Audio pre-amps; ALC, AGC amps; AM & FM compressor/limiters/filters; automatic crossover units; active equalizers & filters VS

ASTATIC CORP
Box 120 Conneaut OH 44030
216 593-1111
Pickups; mics, mic stands

continued on page 94

Total system capability
and a full range
of equipment

Marconi



From the earliest days of broadcasting, MARCONI has been a world leader in the design and production of high performance systems. MARCONI pioneered the automatic camera and only MARCONI offers you second generation automatic cameras ... with a unique design based on the benefits of field experience. There are over 100 MARCONI remote vehicles in service so you can have total confidence in our equipment design and guidance in solving your specific problems.

Whether your interest is in 1 inch VTR's, cameras, transmitters, digital standard converters or complete systems, call MARCONI - our experience, in more than 120 countries, is available to you.

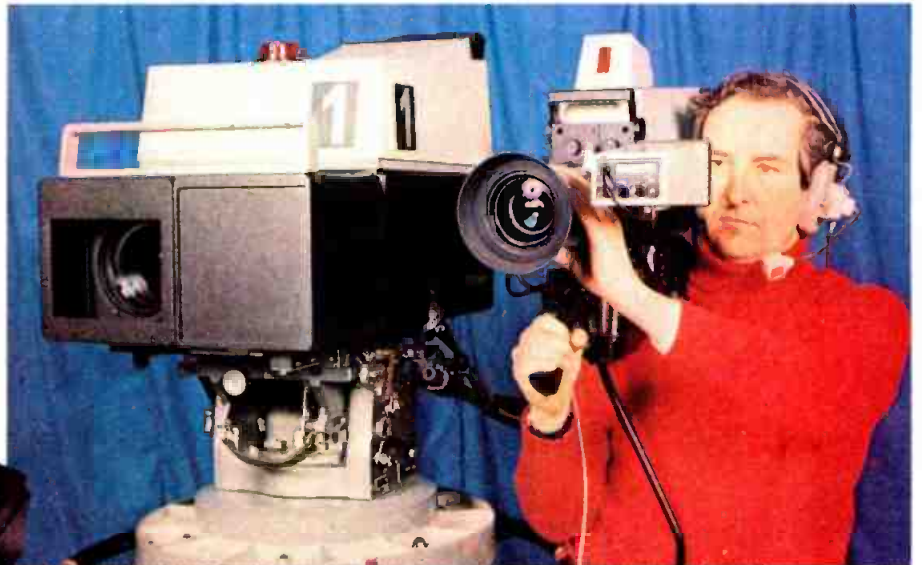

Marconi Electronics, Inc.

100 Stonehurst Court • Northvale, NJ 07647 • 201-767-7250

In Canada, Call Canadian Marconi Company (514) 341-7630

Circle 154 on Reader Service Card

The Source '79

ATLANTIC RESEARCH CORP
5390 Cherokee Ave Alexandria VA 22314
703 354-3400
Mobile van construction. facility turnkey installation.
consulting

ATLAS SOUND
10 Pomeroy Rd Parsippany NJ 07054
201 887-7800
Mic stands & accessories; speakers; columns;
audio connectors **VS**

AUDICO LTD
219 Crossen Ave Elk Grove IL 60007
312 640-1030
Semi-automatic cassette loader **VS**

AUDI-CORD CORP
1845 West Hovey Ave Normal IL 61761
309 452-9461
Tape cartridge player/recorders **VS**

AUDIO ACCESSORIES INC
163 Water St Keene NH 03431
603 352-2320
Patch panels. plugs. jacks. audio connectors **VS**

AUDIO DESIGNS & MFG INC
16005 Sturgeon St Roseville MI 48066
313 778-8400
Audio pre-amps, dist., line amps; slide attenuators;
active equalizers & filters; mono, stereo, quad,
audio for TV mixing consoles; noise reduction
systems; patch panels **VS**
See ad pg 9



AUDIO & DESIGN RECORDING INC (ADR)
PO Box 786 Bremerton WA 98310
206 275-5009
Audio dist amps, pre-amps, ALC & AGC amps,
active equalizer & filters; special effects units: AM &
FM compressor/limiters; delay lines; noise
reduction; VU & PPM level indicators **VS**
See ad pg 179—refer to rep/dist section

AUDIOMARKETING — See Audiotechniques Inc

AUDIONICS OF OREGON
Suite 160 10950 SW Fifth St Beaverton OR 97005
503 641-5225
Audio dist, power & monitor amps; pre-amps;
op-amp modules; quad matrix equip; turntable
pre-amps & controls **VS**

AUDIO PROCESSING SYSTEMS INC
40 Landowne St Cambridge MA 02139
617 354-1144
Active equalizers & filters; quad & multi track mixing
consoles **VS**

AUDIOSEARS CORP
21 South St Stamford NY 12167
607 652-7305
Headphones, dynamic mics **VS**

AUDIO-TECHNICA US INC
33 Shawassee Ave Fairlawn OH 44313
216 836-0246
Headphones; dynamic & condenser mics; phono
cartridges & styli; stereophones; audio accessories;
direct to disc records **VS**

AUDIOTECHNIQUES INC
652 Glenbrook Rd Stamford CT 06906
203 359-2312
Audio amps (monitor, power, public address);
equalizers & filters (active & passive); mixers; mic
booms & dollies; speakers

VS MEANS IT'S VERIFIED

AUDIO TECHNOLOGY
1169 Tower Rd Schaumburg IL 60195
312 885-0066
Audio pre-amps; turntable pre-amps and controls;
PPM level indicators; dB meters

AUDIO/TEK INC
502 D Van Dell Way Campbell CA 95008
408 378-5586
Audio tape duplicators

AUDIOTRONICS CORP
7428 Bellaire Ave, North Hollywood CA 91605
213 765-2645
Stereo pickups; headphones; dynamic, condenser,
lavalier mics; speakers; cassette tape player
/recorders, pulse signal synchronizing equip. **VS**
See ad pg 169

AUDIOTRONICS VIDEO DISPLAY DIV
530 Fifth Ave NW New Brighton MN 55112
612 633-3131
B&w video monitors; data display monitors

AUDIO-VIDEO ENGINEERING CO
65 Nancy Blvd Merrick NY 11566
516 546-4239
Hum bucking coils **VS**

continued on page 96

Scully Recorders



**NOW
being shipped.
Call us!**

With the acquisition of Scully recording instruments,
we are now better able to fulfill a wider range of
equipment for your studio.

We are shipping Scully recorders series 250 and
280-B from our new plant in Pennsylvania.

AMPRO  Scully

Professional Equipment for Broadcasting Professionals
826 NEWTOWN-YARDLEY RD., NEWTOWN, PA 18940
(215) 968-9000 • TWX: 5106672299 • CABLE: AMPROSCUL NTOW

Circle 155 on Reader Service Card

OPTIMOD

CLEANER, BRIGHTER, LOUDER.

OPTIMOD-FM combines compressor, limiter, and stereo generator into an integrated system that's become the #1 audio processor for North American FM's. Users report improved quality, coverage, and loudness—and love the easy installation.

And the new OPTIMOD-AM permits progressive-minded AM broadcasters with quality plants to broadcast a standout signal that's perceived as "almost high fidelity" on common car, table, and portable radios—without loudness loss or objectionable distortion. Hundreds are already in use.

AM or FM—OPTIMOD creates sound that dominates the dial. To find out more, call us toll-free (800) 227-4498. In California or outside the U.S. (415) 957-1067.

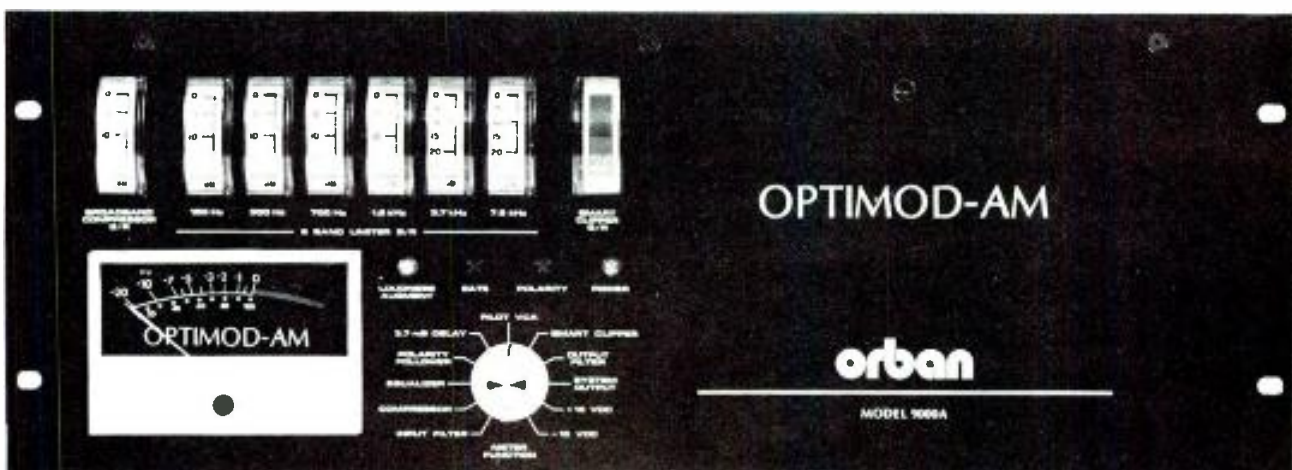
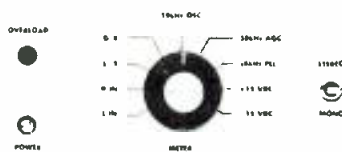

urban

Orban Associates Inc., 645 Bryant Street, San Francisco, CA 94107

Circle 156 on Reader Service Card

The Source '79

AUDITRONICS INC

3750 Old Getwell Rd Memphis TN 38118
901 362-1350

Slide attenuators; mono, stereo, quad, audio for TV,
& portable mixing consoles VS
See ad pg 169

AUERNHEIMER LABS & CO

4561 E Florence Ave Fresno CA 93725
209 442-1048
Speakers VS

AURATONE CORP

PO Box 698 Coronado CA 92118
714 297-2820

Speakers, recording and broadcast reference
monitors VS

AUTOGRAM CORP

631 J Place PO Box 456 Plano TX 75074
214 424-8585

Automation equip; audio amps; mono & stereo
mixing consoles

AUTOMATED BROADCAST CONTROLS INC

1110 Taft St Rockville MD 20850
301 762-0558

Full line radio automation equipment; digital clocks
See ad pgs 188, 204—refer to rep/dist section VS

AUTOMATED BUSINESS CONCEPTS INC

7204 Clairemont Mesa Blvd San Diego CA 92111
714 560-1647

Radio computer business services VS

VS MEANS IT'S VERIFIED

AUTOMATED PROCESSES INC

790 Park Ave Huntington NY 11743
516 427-6024

Automated multi-channel mixer; full line of audio
amps; full line of audio consoles; slide attenuators &
switchers; SMPTE & pulse synchronizing equip;
active & passive equalizers and filters; special
effects; units, intercom systems; telephone coupling
equipment VS

AUTOMATION ELECTRONICS INC

1001 South St Lafayette IN 47905
317 423-2572

Radio business automation systems VS

AVA ELECTRONICS

4000 Bridge St Drexel Hill PA 19026
215 284-2500

Distribution amps, line extenders; coaxial
connectors; camera & lens accessories; RF amps,
attenuators and filters, cables and connectors,
video attenuators, transmission lines and
connectors; TV combiners

AVANTEK INC

3175 Bowers Ave Santa Clara CA 95051
408 249-0700

Microwave STLs; earth station LNAs

AVL DIGITAL LTD

70 Milner Ave Unit 5
Scarborough ONT M1S 3P8 Canada
416 298-6220

Video automation systems;
computer/microprocessor controllers; proc,
clamping, pulse & dist amps; video presence
detectors VS

AVONIX DIV OF AV ELECTRONICS INC

PO Box 505 Brookfield WI 53005
414 784-1800

Videotape editor-controller, V-lock system;
mini-console; production equip rental; post
production services; TV studio design VS

B

BACH AURICON INC

6950 Romaine St Hollywood CA 90038
213 462-0931

Heads, mounts & dollies; cine cameras & lenses

BALD MOUNTAIN LAB

230 Bellevue Rd Troy NY 12180
518 279-9753

Audio stepping test generators, RF filters, off air
frequency measurement services; dB meters VS

BALLANTINE LABORATORIES INC

PO Box 97 Boonton NJ 07005
201 335-0900

Frequency monitors and counters; dB meters;
voltmeters; multimeters; oscilloscopes; digital panel
meters VS

BARBIZON ELECTRIC

426 W 55th St New York NY 10019
212 586-1620

Lamps; full line of lighting hardware & accessories
and light control systems VS

BARDWELL & MCALISTER

7269 Santa Monica Blvd Hollywood CA 90046
213 876-4133

Dist. of lighting equip; heads; stands; fixtures; plugs
& connectors; production & post-production equip
rental & sales VS

BARKER & WILLIAMSON INC

10 Canal St Bristol PA 19007
215 788-5581

RF amps; audio test equip, RF coils; TVI filters,
antenna switching unit, filament & plate chokes

BASF SYSTEMS

Crosby Dr Bedford MA 01730
617 271-4038

Audio tape (open reel, cartridges, cassettes);
calibration tape; videotapes; metal tape

continued on page 98

STROBEGUARD®

HIGH INTENSITY
OBSTRUCTION
LIGHTING SYSTEMS*
FOR TELEVISION AND
RADIO TOWERS AND
SIMILAR SKELETAL
STRUCTURES.



TECHNICAL PRODUCTS GROUP — BEDFORD DIVISION
35 CONGRESS ST., SALEM, MASSACHUSETTS 01970
TEL: (617) 745-3200
ATTENTION: GEORGE MANDEVILLE, PRODUCT MANAGER

*FAA APPROVED as meeting or exceeding the re-
quirements of Advisory Circular AC 150/5345-43 and
FAA/DoD Specifications L-856 plus FAA AC 70/7460-
1E.

Circle 157 on Reader Service Card

isi
means...

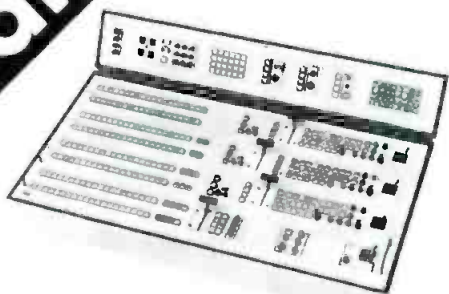

ISI Model 1208—Video Production Switcher



ISI Model 902—Video Production Switcher

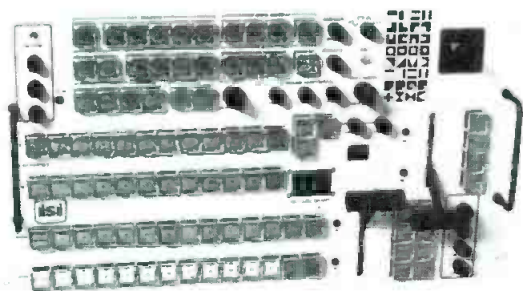

ISI Model 1201R—Video Production Switcher

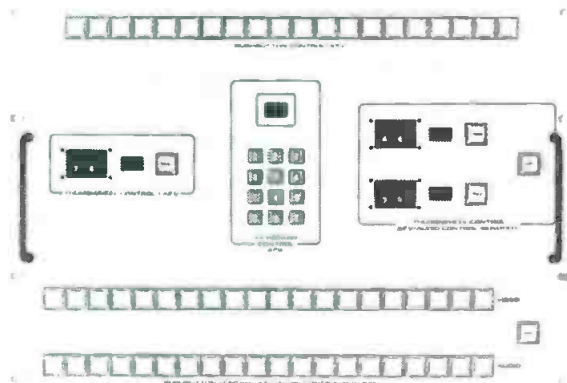

Control Configurations, 1100 Series Routing Switcher

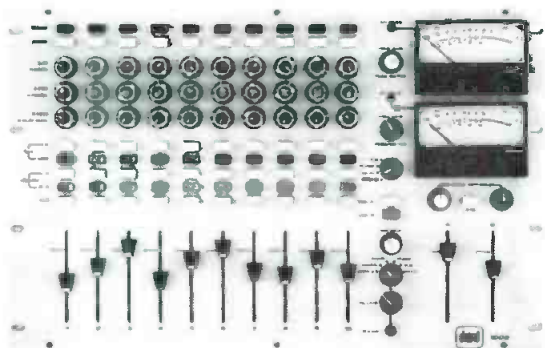

ISI Model 1002—Audio Console

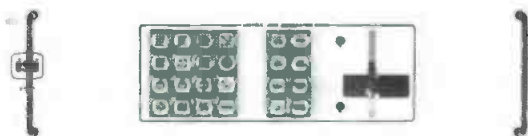

ISI Model 2031—
Matrix Wipe Generator

Innovative Switching Ideas
INDUSTRIAL SCIENCES INC
P.O. Box 1495
Gainesville, FL 32602
Toll Free (800) 874-7590
Florida
(904) 373-6783

The Source '79

BAYLY ENGINEERING LTD (AEG-TELEFUNKEN)

167 Hunt St Ajax Ontario L1S 1P6
416 683-8200

Audio amps (distribution, line, pre-amps, monitor, power); equalizers & filters (passive), portable consoles; intercom systems; patch panels, connectors; exciters; modulators; STLs (intercity, microwave); remote control; receivers, comm & monitor, RF amps, RF loads, RF attenuators, RF convertors, RF filters, RF switchers; AM & FM transmitters & antennas; voltmeters, dB meters, RF wattmeters; emergency power equipment; racks & cabinets; RF tubes, vacuum tubes; camera pickup tubes, rectifiers, surge protectors VS

BCS—See Kaman Sciences

BEAULIEU DIV OF BELL & HOWELL

7100 McCormack Rd Chicago IL 60645
312 262-1600

Film cameras & lenses; camera accessories VS

BEAVERONICS INC

8 Haven Ave Port Washington NY 11050
516 883-4414

Large & small production switchers; master control switchers; post production switchers; SEGs; digital, master & slave clocks; time dist. systems VS

BESELL INC

MOTION PICTURE LAB DIVISION

416 W 45th St New York NY 10036
212 245-8900

Film lab services VS

BEI MICROELECTRONICS

1101 McAlmont Little Rock AR 72203
501 372-7351

Audio processing equip, equalizers and filters (active)

BELAR ELECTRONICS LABORATORY INC

Box 826 119 E Lancaster Ave Devon PA 19333
215 687-5550

AM, FM, & TV frequency & modulation monitors; RF amps; SCA equip; FM & TV translators VS

See ad pg 194

BELDEN COMMUNICATIONS INC

25 W 45th St New York NY 10036
212 730-0172

Lamps (Lee and Thorn), diffusion material, gels and filters, heads, stands & fixtures VS

BELDEN CORP (ELECTRONIC DIV)

PO Box 1327 Richmond IN 47374

317 966-6661

RF cable; audio cable; wire; transmission lines; coaxial cable VS

BELL & HOWELL (AV PRODUCTS DIV)

7100 McCormick Rd Chicago IL 60645

312 262-1600

Film chains; motion picture & slide projectors; camera lenses & accessories, cine cameras VS

BELL AUDIO SYSTEMS INC

994 Freeway Dr N Columbus OH 43229

614 846-2766

Audio amps (dist, pre-amps, power, public address); cartridge tape player/recorders (single) VS

BERKEY COLORTRAN INC

1015 Chestnut St Burbank CA 91502

213 843-1200

Studio & location lights; heads, stands, gels, filters, accessories, camera dollies; light control systems (manual, auto, dimmer packs); patch terminals VS

BESTON ELECTRONICS INC (BEI)

Box 106A Olathe KS 66061

913 764-1900

Automatic telecine light controls; character generators; alphanumeric generators, routing switchers; video slater/prompter; non-duplication switchers VS

BEYER — See Burns Audiotronics

BGW SYSTEMS INC

13130 S Yukon Hawthorne CA 90250

213 973-8090

Monitor, power, PA audio amps VS

JAMES G. BIDDLE COMPANY

Township Line & Jolly Rds

Plymouth Meeting PA 19462

215 646-9200

Frequency monitors & counters; impedance bridges & counters; multimeters VS

BI ELECTRONICS

128 Donaldson Center Greenville SC 29065

803 277-5985

Teletype alarm systems

VS MEANS IT'S VERIFIED

BIRD ELECTRONIC CORP

30303 Aurora Rd Cleveland (Solon) OH 44139

216 248-1200

RF wattmeters; RF loads; RF filters; RF attenuators; RF power monitor/alarms VS

BIRNS & SAWYER INC

1026 No Highland Ave Los Angeles CA 90038

213 466-8211

Camera heads, tripods, dollies; camera & lens accessories; film editing equip; lights & light stands; batteries; equip rental VS

BJA SYSTEMS INC

666 Davisville Rd Willow Grove PA 19090

215 659-4141

Color video synthesizer; colorizer; animation equip; character/graphics systems; segs VS

B&K INSTRUMENTS INC

5111 W 164th St Cleveland OH 44142

216 267-4800

Condenser mics, chart recorders, audio and RF generators, impedance bridges, voltmeters, dB meters, harmonic distortion meters, intermodulation meters, phase meters, RF meters, oscilloscopes, spectrum analyzers, wave form monitors, wow and flutter meters, diff phase-gain VS

BLONDER-TONGUE LABORATORIES INC

One Jake Brown Rd Old Bridge NJ 08857

201 679-4010

RF amps, loads, filters; FM & TV antennas; pay-TV, CATV, MATV systems

BLOOMINGTON BROADCASTING CORP

236 Greenwood Ave PO Box 8 Bloomington IL

61701

309 829-1221

Radio computer business services VS

BOGEN—See Lear Siegler

BOGNER BROADCAST EQUIP CORP

401 Railroad Ave Westbury NY 11590

516 997-7800

Microwave antennas; HP & CP TV transmitting antennas; CATV receiving antennas VS

BONNEVILLE PRODUCTIONS

130 Social Hall Ave Salt Lake City UT 84111

801 237-2400

Audio dist & line amps; high speed tape duplication VS

BOONTON ELECTRONICS CORP

Rte 287 at Smith Rd Parsippany NJ 07054

201 887-5110

FM-AM signal generators; impedance bridges; dB meters; RF watt meters; capacitance test meters; modulation meters

BORG-WARNER (INGERSOLL PRODUCTS DIV)

See Emcor

BOSCH FERNSEH

279 Midland Ave Sadlebrook NJ 07662

201 797-7400

Studio & portable TV cameras; complete telecine systems; VTRs (segmented helical cassette, Type B one-inch, automated systems); color portable monitors; slow motion video action recorders; electronic still stores; digital video effects VS

BOSTON INSULATED WIRE & CABLE CO

65 Bay St Boston MA 02125

617 265-2102

Connectors; wire & cable VS

BOSTON SOUND AND POWER SYSTEMS

3 Fredith Rd Weymouth MA 02189

617 335-8709

Audio amplifiers (distribution, line, pre-amp, op-amp modules, PA); controllers (computer/microprocessors); mixing consoles; digital time clocks; radio computer business services

continued on page 100



THE BETTER WAY

we do
it all...in

Routing Switchers!

small



**D-4300 Series
Video & Audio Switchers**
Available as 6x1 video, 6x1
audio, 16x1 audio-video,
20x1 video and 20x1 audio.
Video only, audio only, or
video-audio. May be
stacked for multiple output
bus applications. Uses
digital control system with
coax remote control cable.
Each output bus has an
independent control system.

medium



**D-400 Series
Video & Audio Switchers**
Available in 20x10, 20x15,
20x20, 30x10 and 30x15 video
and audio basic matrix sizes
which may be used as building
blocks for larger systems for up
to 100 inputs. Control system is
BCD. Each output bus has an
independent control system.

Large

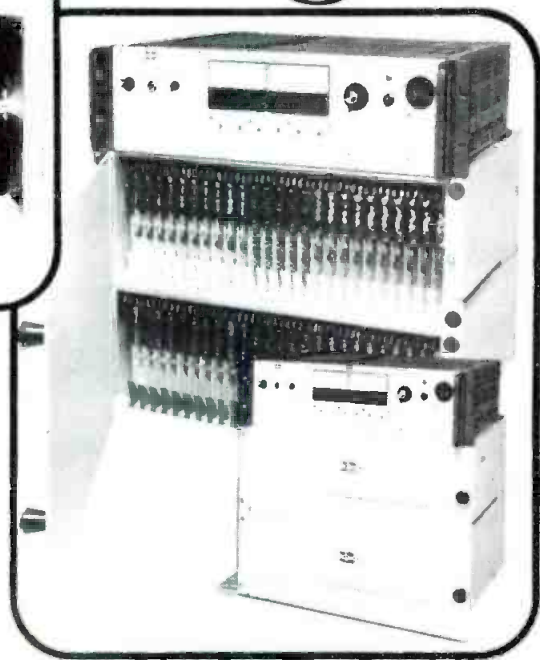

**D-2000 Series
Video & Audio Switchers**
Available in 25x20, 25x25 and 50x25
video and audio basic matrix sizes.
Digital control system is designed for
250 inputs and coax is used for remote
control cable. Each output bus has an
independent control system.

For More Information,
Write or Call

D
DATATEK
CORP

1166 W. CHESTNUT ST. , UNION, N.J. 07083 • (201) 964-3856

Circle 158 on Reader Service Card

www.americanradiohistory.com

Five and Feisty!



CSI is now in its fifth year of offering commercial AM and FM transmitters to the broadcast industry.

CSI ELECTRONICS INC.

3800 South Congress Street • Boynton Beach
Florida 33435 • Phone 305/732-0300 • Telex 513458

In CANADA contact Peter MacFarlane, CSI Electronics, Pointe Clair PQ
Phone 514-695-8130 or 514-484-6601

Circle 159 on Reader Service Card

100 BME SEPTEMBER, 1979

The Source '79



BOZAK INC
587 Connecticut Ave S Norwalk CT 06854
203 838-6521
Amps (pre-amps, monitor, power, public address);
equalizers & filters (passive); delay lines

BPI
7853 Balboa Ave San Diego Calif 92111
714 279-3344
Vollmeters: dB meters; harmonic distortion meters;
intermodulation meters; won & flutter meters VS

BRAND-REX CO
PO Box 498 Willimantic CT 06226
203 423-7771
Flexible transmission line, coaxial cable, wire &
cable VS

BROADCAST AUDIO ASSOCIATES
11355 Pyrites Way Rancho Cordova CA 95670
916 635-1048
Mono, stereo, audio for TV & portable mixing
consoles VS
See ad pg 141

BROADCAST AUTOMATION ASSOCIATES INC
PO Box 277 4100 Metzger Rd Ft Pierce FL 33450
205 464-5465
Audio equipment; radio studio design; facility
turnkey installation

BROADCAST CARTRIDGE SERVICE
1122 E Chevy Chase Dr Glendale CA 92105
213 245-7708
Tape cartridges; empty reels, carts, cassettes;
cartridge tape storage; cartridge reloading
service VS

BROADCAST ELECTRONICS INC
4100 N 24 St PO Box 3606 Quincy IL 62301
217 224-9600
Single, dual, multiple, time delay audio tape
cartridge player/recorders; mono, stereo, audio for
TV, portable mixing consoles; full line of audio
automation equip (relay & time insertion
sequencers, controllers, memory units, reel & cart
machines, auto loggers, tone generators, complete
systems, etc.); audio distribution, line, pre-amps,
monitor, power, PA amplifiers, power supplies; ALC
& AGC amps; AM & FM compressor/limiters, filters;
turntables, turntable pre-amps and controls; tape
timers, cleaners, evaluators, alignment gauges;
telephone coupling equip.; digital clocks, master
clocks, timers; tape loggers, log printers; racks &
cabinets VS
See ad pgs 184, 209

BROADCAST SERVICES CO
PO Box 85 Selma NC
919 284-2102
Dist of radio equip.

continued on page 102

ADDA—THE LEADER IN DIGITAL STILL STORAGE CARRIES THE COUNTRY.

The still store picture from the East Coast to Hawaii is clear. Unequaled insight into broadcasting's digital storage requirements has made ADDA ESP-Systems by far the industry's largest seller.

MILWAUKEE

WTMJ-TV Milwaukee's NBC affiliate WTMJ-TV employs the ADDA ESP-200 for its news programming. The ESP-200, like all ADDA ESP-Systems, is a highly cost-effective replacement for slide chains. ESP-Systems cost less than slide chain equipment and occupy less floor space (only six square feet). Labor and handling costs are substantially reduced and film processing costs as well as time delays are eliminated. ADDA's ESP-Systems provide considerably greater slide capacities. On-line editing allows sequences to be programmed in advance and then reprogrammed while on the air.

MIAMI

WCKT In Miami, NBC affiliate WCKT utilizes the ADDA ESP-750 to create, store, and retrieve stills instantly for its news programming. The ESP-750 features an on-line storage capacity of 1500 frames with up to 100 programmable sequences and 800 programmable frames. Last minute news coverage material can be inserted up to three minutes prior to air time. Only ADDA's ESP digital still store systems conform to new SMPTE digital recording standards at four times the color subcarrier. ESP-Systems are also great for recalling stored character fonts.

HONOLULU

KGMB-TV The commercial production department at CBS affiliate KGMB capitalizes on the creative versatility of the ADDA ESP-200. All of ADDA's ESP-Systems enable you to simulate zoom or animation, spin stills, fade, dissolve, wipe, and super through the program switcher. High resolution stills can be created from live camera, VTR, 16mm film, and network or satellite feeds.

See what ESP-System best suits your needs. Call, write, or check our reader service number for more information and a demonstration. 1671 Dell Avenue, Campbell, CA 95008 (408) 379-1500

ADDA CORPORATION

Circle 160 on Reader Service Card



The Source '79

BROADCAST VIDEO SYSTEMS LTD

Unit 15 1050 McNicoll Ave Agincourt Ontario
M1W 2L8 Canada
416 497-1020

RGB, encoded, luminance chroma keyers (Cox); color correctors (Cox); color encoders (Cox); color monitors (Electronic Visuals); proc, pulse, distribution, sc amps; small production switchers (Cox); MC, post-productions, routing switchers; SEGs; sync generator systems; video delay lines; colorizers; comb decoders; safe area generators; video generators; vectorscopes, waveform monitors, video test generators, pulse width measuring set

See ad pg 138

CA Bdcst Vid Syst 1050 Dominguez E Carson
90746 213 637-2971

BSC INC
2932 River Road River Grove IL 60171
312 452-5551
Cabinets

BSM SYSTEMS
2646 E 37th Ave Spokane WA 99203
509 448-0637
Portable mixing consoles

VS

VS MEANS IT'S VERIFIED

BTX CORP

438 Boston Post Rd Weston MA 02193
617 891-1239

Radio automation equipment (computer/microprocessor controllers, readout displays); SMPTE time code synchronizing systems; manual & automatic audio tape editing

VS

systems; automated master control systems; frame & field synchronizers; two VTR editor/controller, computer-assisted videotape editors; time code generator/readers; audio/video recorder/synchronizers; video identification systems; video/magnetic film synchronizers; digital, master clocks VS
CA J. Hudspeth 6255 Sunset Blvd
Ste 810 Los Angeles 90028 213 462-1506

See ad pg 182—refer to rep/dist section

BUHL OPTICAL

1009 Beech Ave. Pittsburgh PA 15233
412 321-0076

CCTV film chains; slide projectors, multiplexer w.o. dedicated cameras VS

BULOVA WATCH CO INC AM TIME PRODUCTS DIV

61-20 Woodside Ave Woodside NY 11377
212 335-6000

Studio clock systems & frequency standards

BURNS AUDIOTRONICS

5-05 Burns Ave Hicksville NY 11801
516 933-8000

Ribbon, dynamic, studio condenser & wireless mics, mic stands & accessories (Beyer); headphones (Beyer); headsets, wireless infrared headsets (Beyer); audio input transformers VS

See ad pg 160—refer to rep dist section

C

CABLEWAVE SYSTEMS INC

60 Dodge Ave N Haven CT 06473
203 239-3311

Transmission lines & line connectors; microwave antennas; transmission line pressurizing equip; waveguide & waveguide accessories VS

CALICO VIDEO CO INC

PO Box 2405 Stockton CA 95201
209 462-1010

Videotape; reels; cartridges; reloaded carts VS

CALIFORNIA INSTRUMENTS

5150 Convoy St San Diego CA 92111
714 279-8620

Voltmeters, multimeters; oscilloscopes; AC power converters; frequency changers VS

CALVERT ELECTRONICS INC

220 E 23 St New York NY 10010
212 481-5300

Camera pick-up tubes; rectifiers; power tubes VS

THE CAMERA MART

456 W 55th St New York NY 10019
212 757-6977

TV production equipment rental; small production switcher VS

See ad pg 38

CANADIAN GENERAL ELECTRIC CO LTD

396 Attwell Dr Rexdale Ont M9W 5C3 Canada
416 675-7500

Diplexers; VHF & UHF TV transmitters; HP TV antennas; facility turnkey installation VS

CANON SCOOPIC

10 Nevada Dr Lake Success NY 11040
516 488-6700

Professional 16mm motion picture cameras; lenses (including zoom); complete systems VS

CANON USA INC

10 Nevada Dr Lake Success NY 11040
516 488-6700

Video camera lenses, cine camera lenses, camera controls and accessories VS

See ad pg 148

CA Canon USA 123 Paularino Ave E Costa
Mesa 92626 714 979-6000

HA Canon USA 1050 Ala Moana Blvd
Bldg B-2 Honolulu
96814 808 521-0361

IL Canon USA 140 Industrial Drive
Elmhurst 60126 312 833-3070

CAN Canon OBM 3245 American Dr
Mississauga Ontario L4V 1N4 416 678-2730

continued on page 104

"Stainless Towers..."

the best choice we ever made!"



No matter how many times we've heard this from customers, we'd love to hear it this time from you!

When you choose Stainless to fill your tower needs you get quick access to a wealth of experience. We don't just sell towers, we give you performance-proven advice on all aspects of the job, even ones you may have overlooked in your specs.

We'll show you how we cut costs with no sacrifice of quality, using automated processes for faster, cheaper and better results.

Stainless will build to your specs on your site or, we'll pick the best site, run soil analyses, then design, build and erect the optimum performance tower you need. We've been satisfying government, military and industrial customers, worldwide, for over 30 years. Every Stainless Tower, whether 200' or 2000', has priceless experience and reliability built in — to last!

Call Stainless, "the Tower People" and make a good investment for the future.



The tower people

Stainless, inc.

North Wales, PA 19454 U.S.A.
Phone: (215) 699-4871 • TWX: 510-661-8097

CO179

Circle 161 on Reader Service Card

YAMAHA'S NEWEST TOURING PROFESSIONAL.

Yamaha's new PM-2000 Mixer. Ideal for professional sound reinforcement, it's the kind of full production console pros have always had in mind, but never in hand.

The PM-2000. The touch is solid, smooth, consistent. It feels like the professional console that it is.

The knob, switch and slider placement anticipate where your hands will naturally fall.

With 5-position, 4-band equalization and six independent sends on all 32 inputs, plus a full function, 14x8 matrix, the

PM-2000 has everything you would expect from the consummate professional console.

And if the PM-2000 looks and feels like a custom console, and seems to have read your mind, it is no accident. Because Yamaha spent two years on intensive research

and prototypes based on input from professionals. One touch and you'll realize: the PM-2000 feels how you think.

Available early 1979, on a limited basis, through select Yamaha dealerships.



YAMAHA

P.O. Box 6600, Buena Park, CA 90622
Write for complete information on the PM-2000.



Circle 162 on Reader Service Card

The Source '79

CAPITOL MAGNETIC PRODUCTS
DIV OF CAPITOL RECORDS
 1750 N Vine St Hollywood CA 90028
 213 462-6252

Broadcast audio cartridges

VS

See ad pg 79

CA	Cap Mag Prod 1777 N Vine St Los Angeles 90028	213 462-6252
GA	Cap Mag Prod 1670 NE Freeway Access Rd Atlanta 30329	404 321-5441
IL	Cap Mag Prod 6401 Gross Pt Rd Niles 60648	312 775-7101
NY	Cap Mag Prod 1370 6th Ave New York 10019	212 757-7470
TX	Cap Mag Prod 6730 Oakbrook Rd Dallas 75235	214 637-1890

CARINGELLA ELECTRONICS INC
 PO Box 727 Upland CA 91786
 714 985-1540

Clocks, time systems, standard-time receivers,
 audio compressors; security systems

CASES INC

1745 W 134 St Gardena CA 90249
 213 770-4444

Racks, cases (shipping, storage & carrying);
 cabinets

CATEL DIV UNITED SCIENTIFIC CORP
 1400 D Stierlin Rd Mountain View CA 94043
 415 969-9400

FM modulators & demodulators; FM microwave
 subcarrier systems; TV modulators; filters; video
 FM link

VS



CAT CONSTRUCTION CO
 401 E 74 St New York NY 10023
 212 988-0290

Radio & TV studio design, emergency power
 equipment; mobile van construction; facility turnkey
 installation; weather radar systems; computer
 graphics for RF control

CATERPILLAR TRACTOR
 100 NE Adams Peoria IL 61629
 309 675-1000

Emergency power generators

CBS TECHNOLOGY CENTER
 227 High Ridge Rd Stamford CT 06905
 203 327-2000

Quadraphonic encoders, test records

VS

CCA ELECTRONICS CORP
 Box 5500 Broadcast Plaza Cherry Hill NJ 08034
 609 424-1500

AM, FM, UHF & VHF transmitters, translators;
 program sub-carriers; phasing networks; TV
 combiners; RF cables; FM processors; RF
 connectors; AM, FM HP & CP antennas;
 transmission line connectors; antenna tuning units;
 DA equipment; ALC & AGC amps; AM & FM
 compressor/limiters; FM filters; mono, stereo & TV
 audio consoles and mixers; RF duplexers, exciters
 and modulators; remote control systems; RF
 switchers

VS

CECO COMMUNICATIONS INC
 2115 Ave X Brooklyn NY 11235
 800 221-0860

RF tubes, vacuum tubes

CENTRAL DYNAMICS CORP
 10 W Main St Elmsford NY 10523
 914 592-5440

TV automated technical operations systems;
 computerized videotape & audio tape editing equip;
 tape machine synchronizers; processing amps,
 chroma keyers, video production switchers, pulse
 distribution amps, routing switchers; sync
 generators, special effects generators, colorblock &
 cue dot generators, time code readers, video mixing
 amps; computer/microprocessor controllers;
 complete automation systems; video production
 switchers

VS

See ad pg 43

CA	CDL 15130 Ventura Blvd Suite 307 Sherman Oaks 91403	213 789-0574
CO	CDL Denver	303 623-7603
GA	CDL Atlanta	404 491-9037
IL	CDL 331W NW Highway Palatine 60067	312 991-4720
TX	CDL 845 39 St SE Paris 75460	214 785-5764
CAN	CDL 147 Hymus Blvd Montreal Quebec H9R 1G1	514 697-0811

CENTRO CORP
 4848 Ronson Ct San Diego CA 92111
 714 560-1578

Small production switchers; portable production
 consoles; radio & TV studio design; TV van design &
 construction

VS

CENTURY PRECISION CINE/OPTICS
 10661 Burbank Blvd North Hollywood CA 91601
 213 766-3715

Wide-angle lenses for 16mm & 35mm cine use;
 motion picture accessories; cine camera lenses

VS

CETEC GAUSS
 13035 Saticoy St N Hollywood CA 91605
 213 875-1900

Speakers, audio tape duplicators

VS

continued on page 106



The Senator just announced he's running again. Too bad your camera isn't.

If you've lost a story because of weak, unreliable batteries,
 take a look at Alexander Ni-Cad replacement batteries.
 Alexander was a pioneer in the development of nickel-cadmium
 batteries for ENG and EFP. And we're working closely with
 station engineers and videographers to develop new power
 products for even greater reliability.

Alexander. Batteries are our only business.



Alexander Manufacturing Co.
 Box 1645 — 1511 South Garfield Place
 Mason City, Iowa 50401
 Phone (515) 423-8955

Circle 163 on Reader Service Card

America's Largest Manufacturer of Broadcast Cameras. West of the Delaware River.

A JILLION CAMERAS SINCE 1968. We've been at it longer and better than most. Consequently, we know TV cameras. In 1977 we committed CEI to a new direction in broadcast color television cameras. At last components were small. Needs were different. Flexibility was key. And portability was a must. So, we developed the 310 system and not just one more bulky contraption with unnecessary flaps, doors, handles, corners, louvers, wires, cables ... and weight.

TOTE IT. MOUNT IT. POINT IT. USE IT. The CEI 310 is a camera designed to be used. It is a true two-in-one camera which performs beautifully in either studio or field applications. When you want to change from one to the other, you can do so simply in a matter of minutes. Plus CEI cables hook together without special-ordered adaptors — for a range of up to 2400 feet. The CEI 310 is built for real live people. When field equipped, it's naturally suited for the shoulder. The eight pound head rests easily for hours at a time. The cord's exit path follows a normal line down the back of the cameraman.

A SIMPLE LITTLE THING, OUR EU. A six-sided box, blank on four sides: The front panel has all the controls. The rear has all the connections. That's it. Simplicity itself. Inside, the first five of our printed circuit boards handle the normal functions you'd expect. But what we call "board 6" is for today's engineer. Because it's for tomorrow. And it's empty. That's where we put such things as automatic pedestal, iris window shade and a SMPTE time code generator. That's today. For tomorrow there'll be more. The point is, once you've got our basic unit we can offer you bells and whistles for years to come. They'll always fit your 310.

RUGGED RELIABILITY. Kick it around. A lot. The 310 has been places you've never seen: Coal mines, helicopters, surgery, sports fields, studios, wheel wells, fishing piers and cable cars. CEI stands behind our guarantee of service and parts in less than 48 hours. But you don't have a broken 310? We're not surprised. Few people do. That's why we offer you an unedited list of uncoached users. We're betting you'll find a preponderance of good comments about CEI and its cameras.

WE SHOW UP AT THE SHOOT-OUTS. Everybody claims to meet their specifications. And finely-tuned, in a clean room, some do. Ours goes the next step better, in actual use, every day: The 310 actually beats our published specs. We would be happy to lend you a camera for an evaluation in your facility. Our Chief Engineer speaks your language and he is here every day to answer your technical questions. Give us a call.

CEI

880 Maude Avenue
Mountain View, CA 94043
(Telex) 348-436
(415) 969-1910

Maybe someday all cameras
will look like ours.



Circle 209 on Reader Service Card

The Source '79

CETEC BROADCAST GROUP

1110 Mark Ave Carpinteria CA 93013
805 684-7686

Relay & time insertion sequencers;
computer/microprocessor controllers; memory
units; reel decks; multi-cart machines; read
out/displays; data input devices; auto loggers; tone
generators; auto time/weather announcers;
complete automation systems; mono, stereo, quad,
audio for TV & portable mixing consoles; turntables;
pickup arms; stereo & quad pickups; turntable
pre-amps & controls; complete disc consoles;
speakers; cabinets & furniture; complete studio
construction; single, dual, multiple & time delay
cartridge tape player/recorders; bulk erasers;

cartridge tape storage; exciters; SCA equipment;
AM & FM transmitters; FM antennas; HP & CP TV
antennas VS

See ad pg 173— refer to rep/dist section

CEZAR INTERNATIONAL

491 Macara Ste 1003 Sunnyvale CA 94086
408 733-1436

Video presense detector; VTR framing servo; fade
to black unit; VTR audio editing equip; waveform
monitors & analyzers VS

CHANNELMATIC INC

2232 Lindsay Michelle Dr Alpine CA 92001
714 445-2691

Audio dist. amps; audio switchers; automation
controllers (computer/microprocessor); telephone
coupling equip; video distribution amps; quad cart
automation controllers and complete systems;

video presence detectors; RF remote control
systems; timers; cable TV programmers; pay TV
earth station automated systems VS

CHRISTIE ELECTRIC CORP

3410 W 67th St Los Angeles CA 90043
213 750-1151

Batteries, battery chargers; power packs for video
cameras VS

See ad pg 92

CHRONO-LOG CORP

2 W Park Rd Havertown PA 19083
215 853-1130

Digital clocks & calendars; time-code generators &
readers; master & slave clocks; time distribution
systems VS

CHYRON TELESYSTEMS

233 Newton Rd Plainview NY 11803
516 249-3296

Character generators; graphics systems; special
effects generators; alphanumeric generators VS

See ad pg 171

CHYRON CORP VIDEO PRODUCTS DIV

265 Bethpage-Spagnoli Rd Melville NY 11746
516 249-5202

Video cassette cleaning & evaluating VS

VS MEANS IT'S VERIFIED

CINE 60 INC

630 Ninth Ave New York NY 10036
212 586-8782

ENG camera braces; quick releases; power packs
for portable cameras; batteries & chargers; portable
lights, kits VS

CINEMA PRODUCTS CORP

2037 Granville Ave Los Angeles CA 90025
213 478-0711

ENG/EFP cameras, 16mm film cameras; lenses for
16mm cameras; camera tripods, body braces;
video/film camera stabilizing system; camera sound
recording systems & accessories; telecine system;
film editing equipment; batteries & battery chargers;
lighting fixtures VS

See ad pg 129

DAVID CLARK CO INC

360 Franklin St Worcester MA 01604
617 756-6216

Headphones, intercom systems VS

CLEAR/COM

759 Harrison St San Francisco CA 94107
415 989-1130

Portable intercom systems VS

See ad pg 166—refer to rep dist section

CMC TECHNOLOGY CORP

733 N Pastoria Ave Sunnyvale CA 94086
408 245-3342

Refurbished quad heads; velocity compensators;
auto chroma equalizers; differential gain channel
amp VS

See ad pg 24-25

CA CMC 125 W Providencia Burbank
91502..... 213 841-7781

CMX SYSTEMS DIV OF ORROX CORP

3303 Scott Blvd Santa Clara CA 95050
408 988-2000

Videotape editing equip, time code
generators readers; telecine systems; open-reel &
cassette electronic editing systems; audio/video
recorder synchronizers VS

See ad pg 17

PA M Beviz PO Box 355 Springhouse
19477..... 212 371-1122

COASTCOM

2312 Stanwell Dr Concord CA 94520
415 825-7500

Demodulators; diplexers; modulators; video filters;
subcarrier amps; program subcarriers; AM & FM
compressor/limiters/filters; passive and active
equalizers and filters; microwave supports and
portable equipment; satellite earth stations; carrier
current, FM processors; status and alarm
indicators VS

continued on page 108

When you need a reliable professional color monitor...

Ask for Videotek

The name that was built on
Quality and Service.

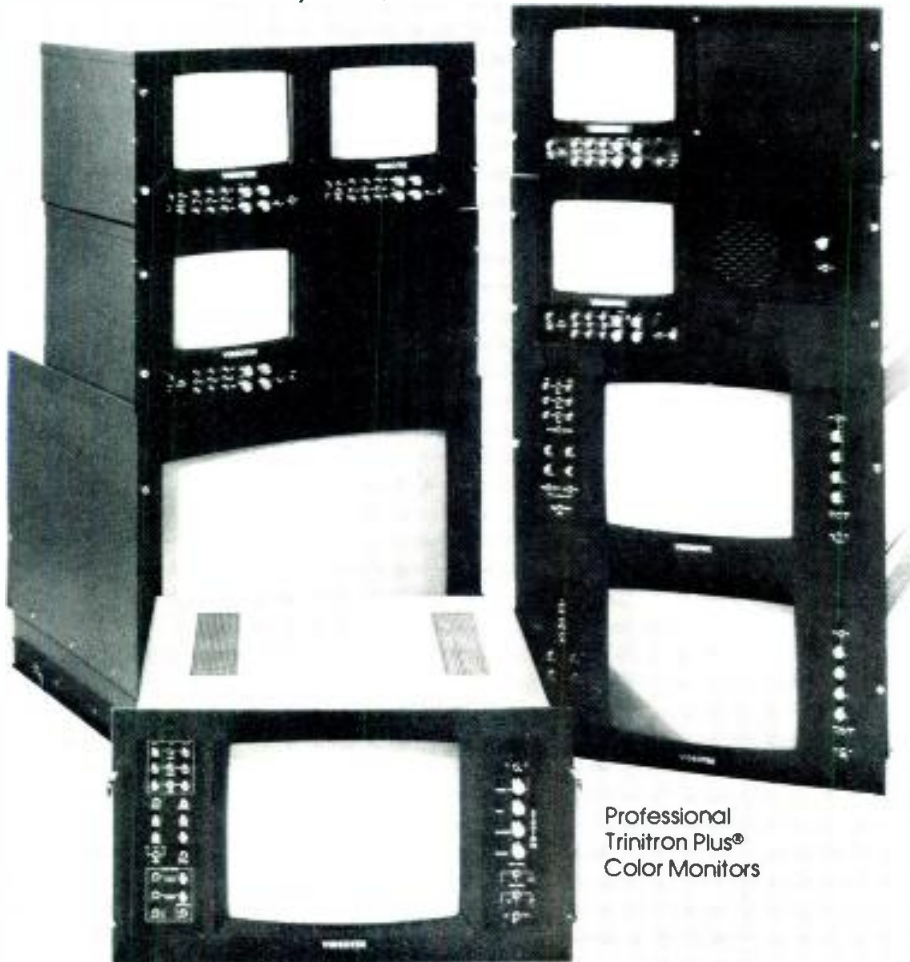

Professional
Trinitron Plus®
Color Monitors

QUALITY ENDURES AT:

VIDEOTEK INC

125 North York Street, Pottstown, Pennsylvania 19464 / (215) 327-2292
9625 North 21st Drive, Phoenix, Arizona 85021 / (602) 997-7523

Circle 164 on Reader Service Card

UREI's Dynamic Duo

Two Graphic Equalizers in one package...

Two for one price.

UREI
**QUALITY
OF COURSE**

The UREI model 535 Dual Graphic Equalizer is two independent graphic equalizers with one common power supply. As a successor to the popular model 530, it offers an additional filter section per channel plus greater control range and more output capability. The 535 provides 12dB of boost or cut at each of its 10 frequencies centered at preferred ISO one-octave increments from 31.5 Hz to 16 kHz. Filters have excellent combining action with minimum phase shift. Input capability of +20 dBm and output of +24 dBm, combined with excellent S/N provides exceptional dynamic range. S/N is better than 110 dB at maximum output. Front panel controls adjust gain from -10 dB to +20 dB. Get two equalizers in one package. Save rack space and save money too. See the 535 at your UREI dealer today!

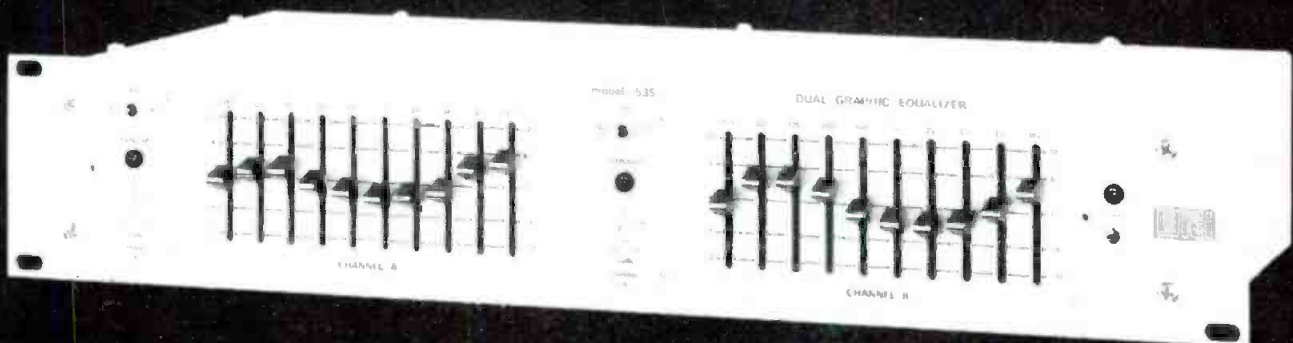

UREI

8460 San Fernando Road, Sun Valley, California 91352 (213) 767-1000

Worldwide: Gotham Export Corporation, New York; Canada: E. S. Gould Marketing, Montreal

The Source '79

COAXIAL DYNAMICS INC

13110 Enterprise Ave Cleveland OH 44135

216 267-2233

RF filters, RF loads, RF switchers, directional power detectors, couplers, RF wattmeters, adjustable-tap RF sampler

COHERENT COMMUNICATIONS CO

13733 Glenoaks Blvd Sylmar CA 91342

213 362-2566

Distributor ALC & AGC amps, AM & FM compressor/limiters, equalizers & filters, spec effects units, (Audio Developments); PA stabilizer:

VS MEANS IT'S VERIFIED

distributor of mono, stereo, quad, audio for TV, portable mixers (Audio Developments); distributor of condenser, wireless, lavalier mics (Artech); mic power supplies; digital footage counter, blooper for cine cameras; induction receivers; location equipment cart; distributor of mic windscreens (Rycote) **VS**

COHU INC ELECTRONICS DIV

PO Box 623 San Diego CA 92112

714 277-6700

Video color encoders; telecine multiplexers & complete systems; b & w picture monitors; pulse, distribution & equalizer amps; sync generator systems; automatic telecine light control; video equalizers, equalizing amps **VS**

See ad pg 178—refer to rep/dist section

AL Cohu 4100 Aldebaran Way
Mobile 36609..... 205 661-9088

CA Cohu 2229 N Tracy Ave Sim Valley
93063..... 805 522-3357
CA Cohu 2307 Orange Ave
Costa Mesa 92627..... 714 772-5211
CA Cohu 770 Welch Rd Suite 154 Palo
Alto 94305..... 415 326-0208
MI Cohu 27962 Sutherland Dr Warren
48093..... 313 776-6690
NJ Cohu 23 E Madison Ave Florham
Park 07932..... 201 377-6636

COLLINS TRANSMISSION SYSTEMS DIV COMMERCIAL TELECOMMUNICATIONS GROUP ROCKWELL INTL

PO Box 10462 Dallas TX 75207

214 996-5340

Audio pre-amps; mono & stereo mixing consoles; intercity microwave equip; exciters; satellite earth stations; AM & FM transmitters; FM antennas **VS**
See ad pg 165

AL D Hultsman 2280 Rockcreek Trail
Birmingham 35226..... 205 822-1078
CA WR Sheffield PO Box 23056 San Jose
95123..... 408 998-8048
IL JD Abdnour PO Box 575 Streator
61364..... 815 672-8585
MN JL Littlejohn 200C W Branch Rd
Maple Plain 55359..... 612 479-2633
MO JC Shideler Rte #1 Box 217-B
Oak Grove 64075..... 816 443-2080
NH CA Fosmark 105 Spit Brook Rd Villa 13E
Nashua 03060..... 603 888-6789
NJ KA Leach PO Box 16 Newton
07860..... 201 383-8797
OR CC Cauthers 1215 S. E 73rd Ave Portland
97215..... 503 254-2818
TN RC Evans PO Box 143 Alcoa
37701..... 615 573-9717
TX SH Schett Box 2008 Plano
75074..... 214 423-3644

COLORADO VIDEO INC

PO Box 928 Boulder Co 80306

303 444-3972

Video special effects generators; colorizers; repositioners; waveform monitors & analyzers; video presence detectors; slow scan TV; video test generators; electronic still stores **VS**

See ad pg 135

MA Colorado Video 17 Amble Rd Cheimstord
01824..... 617 256-3381

COLUMBIA VIDEO SYSTEMS

Laurel and Second Highland Park IL 60035

312 433-6010

Production equip, rental; post-production services; TV studio design; videotape/film recording, transfers **VS**

COLUMBINE SYSTEMS INC

1301 Arapahoe PO Box 740 Golden CO 80401

303 279-4000

Computer business systems for radio, TV **VS**

COMAD COMMUNICATIONS LTD

91 Kelfield St Unit 5 Rexdale

ONT CAN M9W 5A3

416 245-1734

Video master control switchers; automated master control systems; routing switchers **VS**

COMARK COMMUNICATIONS

PO Box 267 Southwick MA 01077

413 569-5939

Demodulators, diplexers, exciters, modulators; remote control systems; RF amplifiers, filters, switchers, loads, converters, attenuators; VHF & UHF TV transmitters; phasing network and TV combiners; antennas (microwave, FM, HP, CP), transmission line & connectors, TV studio design; facility turnkey installation **VS**

COMET VACUUM CAPACITORS

PO Box 4755 Springdale CT 06907

203 329-2764

Vacuum capacitors **VS**

COMEX SYSTEMS - See Wang Labs

COMMERCIAL ELECTRONICS INC (CEI)

880 Maude Ave Mountain View CA 94043

415 969-1910

Studio cameras; studio/field convertible cameras; ENG/EPF cameras; camera accessories **VS**

See ad pg 105—refer to rep/dist section



*It's
showtime
in Tokyo.*

1979 JAPAN BROADCAST EQUIPMENT EXHIBITION

The time: October 24 to October 26
The Place: Science Museum, Kitanomaru Park, Chiyoda-ku, Tokyo.
The going-on: 4000 square meters of exhibit space—see all the newest advances in broadcasting equipment.

Sponsor: Electronic Industries Association of Japan.
Co-Sponsor: The National Association of Commercial Broadcasters in Japan
NHK (Japan Broadcasting Corporation).
Management: JAPAN ELECTRONICS SHOW ASSOCIATION
No.24 Mori Bldg., 23-5, Nishi-Shinbashi 3-chome, Minato-ku, Tokyo, Japan.

Circle 166 on Reader Service Card

continued on page 113

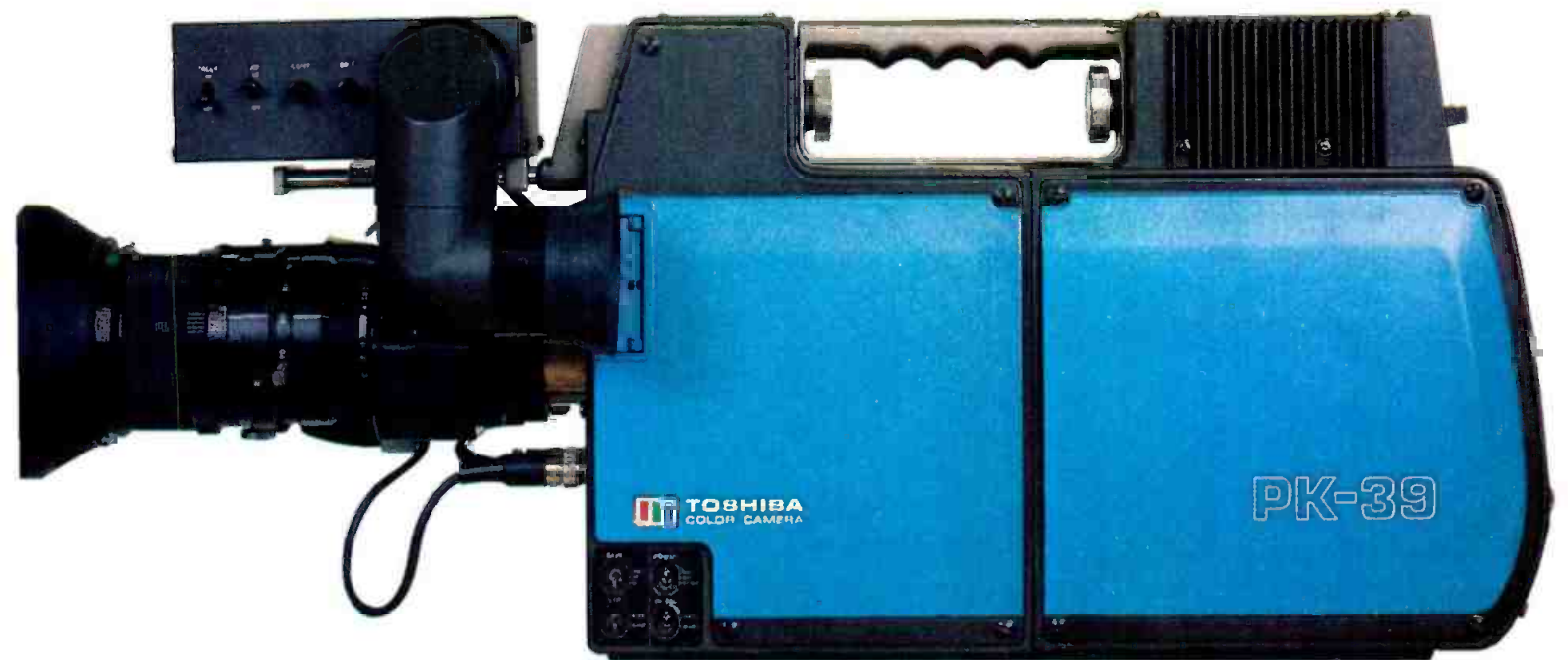

Four Solid Reasons Why Toshiba's PK-39 Stands Head And Shoulders Above Them All

We brought together three of North America's leading broadcast equipment distributors and asked them to provide us with some candid observations about our PK-39 portable Broadcast Camera... to make point.

We want you to know that our growing family of distributors is ready to tell you that the PK-39 does a lot of important things that set it apart from other cameras.

The PK-39 is a light, 14-pound camera system for both remote and studio applications. It is perhaps the most versatile, flexible ENG/EFP broadcast camera ever designed. Self-contained or two-piece, it offers auto beam control, auto white balance, and auto iris. It will accept either Plumbicon* Saticon** tubes. It also has an optional 5-inch studio viewfinder.

Think these three distributors, like the others you'll soon be hearing from, are solid reasons you should consider the PK-39. We are

"The PK-39 is the 'available light' camera. The dynamic range and contrast ratio are superb."
Mac Brainard
Video Systems Network
Los Angeles

"Toshiba has built a lot of unique features into the PK-39, such as a vertical interval test signal that simplifies VTR color phase playback. We saw it. We liked it. We recommend it."

*Al Cervenko
Video Equipment Corporation
of America
San Diego*

selectively building a strong regional distributor system that will offer you better products, service and support than you may be getting now.

"If an ENG newsman, field production specialist and chief engineer each gave us their specifications and ideas, we would give them the PK-39. It's been designed with each in mind."

*Bill Dwyer
Lake Systems
Newton, Mass*

The fourth reason is Toshiba's own factory engineering, service and support organization—located in Sunnyvale, California, and Atlanta, Georgia. We'll bet it, too, is better than what you're used to. And our distributors know it's just the beginning. There's lots more to come from Toshiba.

Discover for yourself by learning more about our complete camera line. See your distributor. Or call Toshiba's Broadcast Electronic Systems Division, collect. (408) 734-9172. 292 Gibraltar Drive, Sunnyvale, California. 94806. In Atlanta it's 2971 Flowers Rd. So. Phone (404) 458-9562.

TM N. V. Philips TM Hitachi

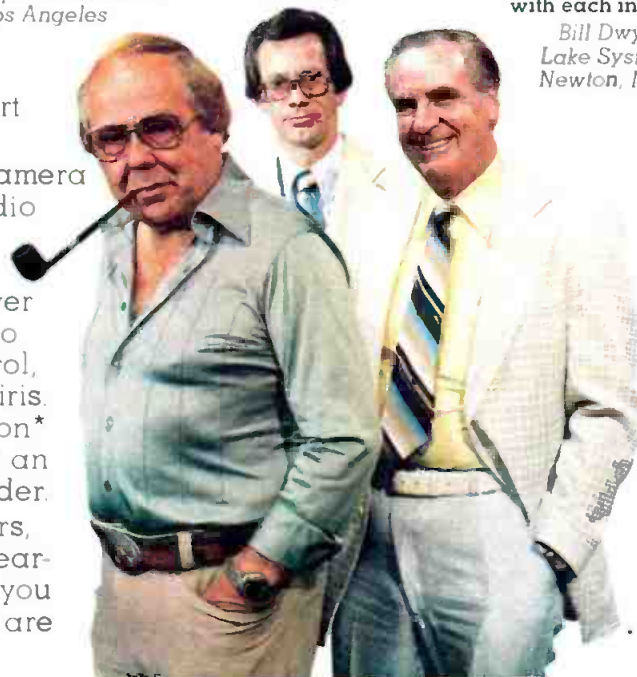

TOSHIBA

... In touch with tomorrow

Circle 167 on Reader Service Card

Family Technology

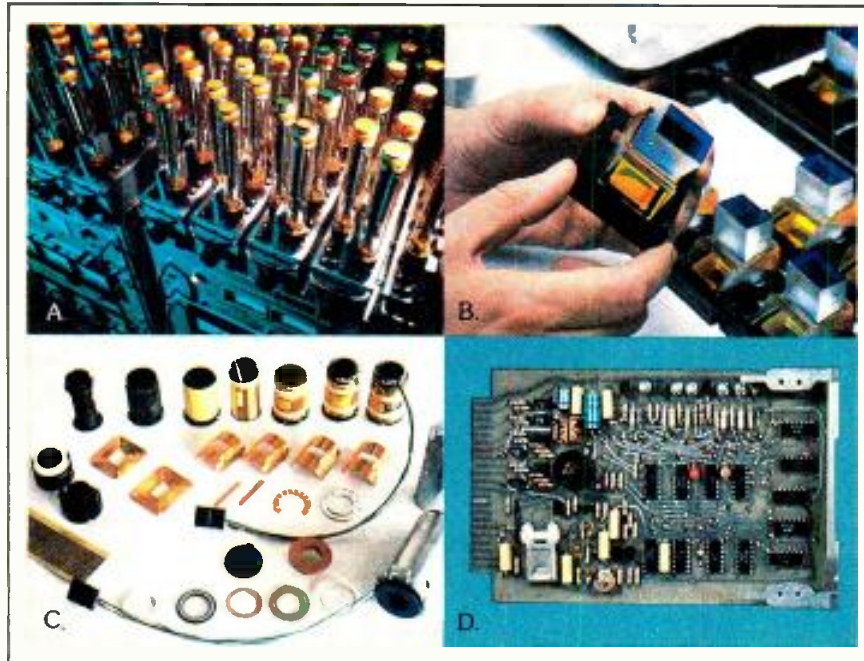

A. Plumbicon™ Tube Technology
C. Yoke Technology

B. Prism Technology
D. Electronic Circuitry Technology

Philips called it, “Focus on Technology” at NAB ’79 in Dallas. Simply put, it was a demonstration of the single, most important reason for the basic superior technology and design advantages that make Philips the acknowledged leader in color television:

“Philips is the *only* camera manufacturer who designs, develops and produces *all* four, critical, picture-determining components — Pick-up Tubes, Prisms, Deflection Yokes, and Electronic Circuitry — each designed for optimum, total camera system performance.”

This basic technological advantage enables Philips to continue offering the world’s finest line of broadcast cameras. The most diversified camera family in both price and application. *The Technology Family.*



Technology Family



LDK-14—Newest technological breakthrough.

$\frac{2}{3}$ -inch ENG/EFP/Studio broadcast camera with picture quality and features of Philips larger studio cameras. Lightweight, rugged, one piece with the look and feel of a film camera. Low power consumption; high sensitivity; dynamic beam control (DBC); fully automatic operation including auto-centering, and switchable black stretch. Available with simplified remote control or full facility control unit with full bandwidth chroma key.



LDK-25 Family with ACT or new 1-inch 73XQ Diode-Gun Plumbicons and camera circuitry for higher resolution and lower lag than 30mm cameras. With better than 65% depth of modulation at 400 lines! Makes the finest, state-of-the-art multicore studio and field camera ever produced better than ever. And Philips exclusive rear-loading design delivers the maximum out of this new Diode-Gun technology.

Rounding out the LDK-25 family are: the LDK-5, a digitally controlled triax version for remotes and modernized studio operation; and the LDK-15L, an LDK-5 in a self-contained mode or can be used with the LDK-5 or 25 CCU in system configurations.



VIDEO 80... innovative convertible camera system for multi-use applications. Unique, three $\frac{2}{3}$ -inch Plumbicon camera head converts in seconds from studio mode (available with optional, multi-position, tiltable viewfinder) to new, lightweight EFP field production mode with $1\frac{1}{2}$ " viewfinder to totally self-contained ENG portable. Even to special application modes for telecine, microscopy, endoscopy, etc. Easy set up and operation by non-technical personnel and automatic features for total mobility. VIDEO 80 also offers a complete expandable production system for start up or expansion of existing systems.

I.F. Transmitters... Philips is also the recognized world leader in transmitter technology, now with the fastest growing UHF/VHF transmitter line in North America. Output ranges up to 110kW. Equally suited for single or parallel operation with

automatic or remote control for unattended operation.



Features include I.F. modulation, solid state design except for power stages, high stability and ease of installation and maintenance. SAW filter, reducing number of controls to achieve proper group-delay. Small size and minimum floor space made possible by the advanced design and a unique common exciter that can be retrofitted into earlier competitive systems.

Also included in Philips "Focus on Technology" and part of our growing family of system products:

- One-inch **Video Recorders** to meet your specific requirements.
- New digital **Video Noise Reducer** — Fully automatic.
- A state-of-the-art **Tape Synchronizer** for totally integrated systems operation.

It all adds up to the widest range of cameras and television equipment in the industry. More information is yours simply by writing today on your company letterhead (indicating product interest) to: Philips Broadcast Equipment Corp., 91 McKee Drive, Mahwah, N.J. 07430 (201) 529-3800. (Canada: Philips Broadcast Equipment, 601 Milner Ave., Scarborough, Ontario M1B1M8).

Innovative Leader in World Television

PHILIPS
TM-N.V. Philips



RCA



It's the RCA tradition of growth and innovation; a tradition of being an engineer's company dedicated to pioneering new technologies. We brought

Nipper™ back to emphasize the fact that although we are one of the nation's largest industrial firms, we are still an imaginative, pioneering bunch of innovators not unlike the group who started it all. If you have some ideas you'd like to get on the move, talk with us. We have openings at all experience levels for BS/MSEE's with backgrounds in RF systems and antenna design, closed loop servo systems, high speed digital signal processing, VTR's, and related areas of

electromagnetic imaging, recording, and transmission. For further career information with RCA in the above areas, send your resume and background information to John Hendrickson, RCA Broadcast Systems, Bldg. 3-2, Camden, NJ 08102. We'll return a full-color print of our familiar trademark Nipper, to you, suitable for framing, at no obligation.

We are an equal opportunity employer Male/Female.

**A Tradition
On The Move!**

The Source '79

COMMUNICATION TECHNIQUES INC
36 Route 10 E Hanover NJ 07936
201 884-2580
RF & microwave phase locked oscillators

COMPUTER BUSINESS SYSTEMS INC
167 Moore Rd Weymouth Ind Pk Weymouth MA 02189
617 337-7799
Time insertion sequencers;
computer/microprocessor controllers; memory units, read out/display, data input devices; computer business services (radio)

COMPACT VIDEO SALES INC
1104 W Chestnut Burbank CA 91505
213 843-3232
Mono, stereo, audio for TV & portable mixing consoles; complete audio studio construction; videotape cleaning & evaluating equip; portable microwave equip & supports; production equip & post production service; radio & TV studio design; videotape/film recording transfer; emergency power equip; mobile van construction; facility turnkey installation VS

COMPUTER IMAGE CORP
2475 W 2nd Ave Denver CO 80223
303 934-5801
Animation equip, computer animation services

COMPUTER LABS DIV ANALOG DEVICES INC
505 Edwardia Dr Greensboro NC 27409
919 292-6427
A/D converters, D/A converters VS

COMPUTER MAGNETICS CORP
125 W Providencia Ave Burbank CA 91502
213 843-6674
Refurbished VTR and audio heads; video discs; color correctors; video equalizers; diff phase-gain measurement

COMQUIP INC
366 S Maple Glenrock NJ 07452
201 444-3800
Distributor of studio cameras, ENG/EFP cameras, camera lenses and accessories, tripods and dollies, telecine equipment, monitors, video processing equip, small production switchers, SEGs; VTRs; film equip

COMREX CORP
PO Box 269 Sudbury MA 01776
617 443-5077
Wireless mic systems; RF cue systems; off-air pocket aural monitor; low frequency extenders; radio ENG repeater systems; telephone integrator/conferencer systems VS
See ad pg 120, 121

COMSONICS INC
PO Box 1106 Harrisonburg VA 22801
703 434-5965
Surge protectors; RF leakage detector

CONRAC CORP
600 N Rimsdale Ave Covina CA 91722
213 966-3511
TV monitors VS
See ad pg 39—refer to rep dist section
CA W Erms 600 N Rimsdale Ave
Covina 91722 213 966-3511
IL J Keenan 627 N York Rd Elmhurst
60126 312 833-3310
NJ R Sanford 85 Orient Way Rutherford
07070 201 939-8444
TX F DuVal 2925 LBJ Fwy Ste 157
Dallas 75234 214 243-1834
CAN B Mitchell 345 Kingston Rd Ste 210 Pickering
Ontario L1V 1A1 416 281-3215

CONRAC CORP SYSTEMS EAST DIV
32 Fairfield Pl W Caldwell NJ 07006
201 575-8000
Large screen projectors; production equipment rentals and post production services VS

VS MEANS IT'S VERIFIED



CONSOLIDATED ELECTRONIC INDUSTRIES INC
Waterview Bldg Ste 906 1925 N Lynn St
Arlington VA 22209
703 524-9811

Radio automation equip, (studio systems, open-reel decks, controllers, cart decks, read out/display data input devices, complete systems) VS
See ad pg 30

CONSOLIDATED VIDEO SYSTEMS
1255 E Arques Ave Sunnyvale CA 94086
408 737-2100

Image enhancers; digital noise reducers/filters; computer assisted video tape editors; audio/video recorder synchronizers; time base correctors (quad, helical capstan servo & non-servo); frame synchronizers for NTSC, PAL, PAL-M & SECAM; digital still store systems VS
See ad pg 131

AL	J Knight 11001 Donnetta Dr Huntsville	35810	205 852-9358
CA	M Lang 1255 E Arques Ave Sunnyvale	94086	408 737-2100
IA	C Selthun 1421 W 1 St Pella	50219	515 628-9389
MD	J Wellman 2066 Whitney Ln Bell Air	21014	301 879-1794

CONTINENTAL ELECTRONIC (CONTEL)
1620 W 32 Pl Hialeah FL 33012
305 822-1421

Tape cartridge single player/recorders

CONTINENTAL ELECTRONICS MFG CO
PO Box 270879 Dallas TX 75227
214 381-7161

High-power AM broadcast transmitters; 5 10 kW transmitters; AM antennas; diplexers & RF loads VS
See ad pg 186, 194, 205, 209

CONTROL TECHNOLOGY INC
991 SW 27th Ave Ft Lauderdale FL 33312
305 587-2716

Dist. of full line radio automation equip. VS

CONVERGENCE CORP
1641 McGaw Irvine CA 92714
714 549-3146

Video editing control systems (two VTR & computer-assisted), time code gens/readers VS
See ad pg 133

COOPER GROUP ELECTRONICS DIV
PO Box 728 Apex NC 27502
919 362-7511

Soldering guns, wire stripping tools, hardware; hand tools

COPPERWELD BIMETALLICS GROUP
Robinson Plaza II Pittsburgh PA 15205
412 777-3000

Tower hardware & construction equipment; wire & cable; cable distribution & drop

D & S CORLEY LTD
80 Galaxy Blvd Unit 3 Rexdale Ontario M9W 4Y8
Canada
416 675-3511

Video test charts & slides; video test generators

CORNING GLASS WORKS
3900 Electronic Drive Raleigh NC 27604
919 876-1100

Video delay lines, ultra sonic delay lines

COX DATA SERVICES
Suite 100 Prado N 5600 Roswell Rd NE Atlanta GA 30342
404 256-5200
Computer systems for TV and CATV VS

COYNE ASSOC
1010 Sherbrook St W Ste 307 Montreal Que H3A 2R7 Canada
514 282-8027
Computer aided systems design for CATV; broadband consulting service

CPAC INC
2364 Leicester Rd Leicester NY 14481
716 382-3223
Silver recovery and pollution control systems VS

CROMPTON INSTRUMENTS INC
2763 Higgins Rd Elk Grove Village IL 60007
312 593-1107
VU & PPM audio level indicators; voltmeters; dB meters; transformers VS

CROSSPOINT LATCH CORP
316 Broad St Summit NJ 07901
201 273-1090
Intercom systems; encoded chroma keyers; color encoders; small production switchers; special effects generators; sync, color bar, black burst generator systems; colorizers VS

CROWN INTL
1718 W Mishawaka Rd Elkhart IN 46514
219 294-5571
Audio power amps, audio preamps; equalizers; variable filters; intermodulation distortion test equip; time analyzation equip

CSI ELECTRONICS INC
3800 S Congress Ave Boynton Beach FL 33435
305 737-5626
Transmitters (AM, FM, carrier current); status and alarm indicators; stereo and SCA generator VS
See ad pg 100

CSP INC
203 Airport Rd Doylestown PA 18901
215 345-7386
RF inductor, diplexers, remote control system, RF filters, RF loads, RF switchers, phasing network, antenna tuning unit, DA equip

CUSTOM AUDIO ELECTRONICS
2828 Stommel Rd Ypsilanti MI 48197
313 482-6568
Audio mixing consoles (stereo and portable); intercom systems; manual light control systems VS

D

DABURN ELECTRONICS & CABLE CORP
70 Oak St Norwood NJ 07648
201 768-5400
Wire and cable, connectors, terminals VS

DAGE-MTI INC
208 Wabash St Michigan City IN 46360
219 872-5514
TV mono cameras; b&w picture monitors; distribution amps; sync generator systems; small production switcher; CCTV systems VS

The Source '79

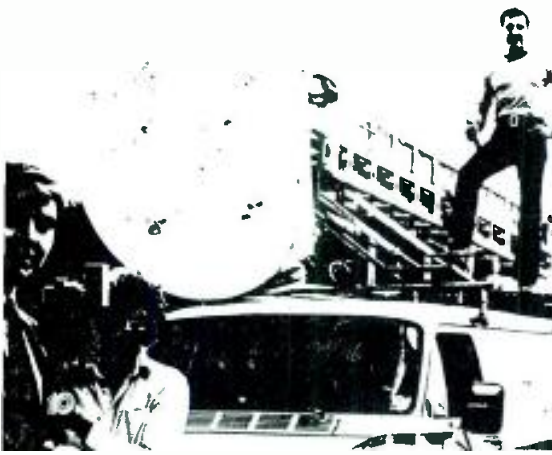

VS MEANS IT'S VERIFIED

DAK INDUSTRIES INC

10845 Vanowen St N Hollywood CA 91605
213 984-1559 800 423-2636

Audio tape (open reel, cartridges); empty reels, carts & cassettes; leader tape; new videotape; audio tape duplication services

DATA COMMUNICATIONS CORP (BIAS)

3000 Directors Row Memphis TN 38131
901 345-3544

Computer service for sales, traffic, operations & accounting (TV & radio)

DATAMETRICS INC

340 Fordham Rd Wilmington MA 01887
617 658-5410

SMPTTE time code gens/readers, digital clocks, master & slave clocks VS
See ad pg 154

DATA PRECISION CORP

Electronics Ave Danvers MA 01923
617 246-1600

Frequency monitors and counters; voltmeters; multimeters; capacitance meters; ohm meters; thermometers VS

DATATEK CORP

1166 W Chestnut St Union NJ 07083
201 964-3656

Audio dist. amps; video color correctors; video pulse, dist, subcarrier amps; time code routing system; routing switchers; signal equalizing systems; black burst sync generator systems; video filters; equalizers; video sweep generators, envelope delay test set VS
See ad pg 99—refer to rep dist section

DATATRON INC

PO Box 11427 Santa Ana CA 92711
714 540-9330

Videotape editing equip (two VTR and computer-assisted); time code readers/generators VS
See ad pg 21

DBC LTD

124 Belfield Rd Rexdale Ontario Canada
M9W1G1
416 241-2651

RF diplexers, modulators, receivers, comm & monitor, amplifiers, attenuators, converters, filters, switchers; TV/translators, VHF & UHF TV transmitters, Cable TV amps; facility turnkey installation VS

DBX INC

71 Chapel St Newton MA 02195
617 964-3210

Tape recorder noise reduction systems; compressor limiters, dynamic expanders; noise reduction modules, gain control modules; dB meters VS

DECCA AUSTIN INSULATORS

71 Selby Rd Brampton ONT L6W 1K5
416 457-8722

Insulators, transformers for towers and antennas

DELTA ELECTRONICS INC

5730 General Washington Dr Alexandria VA
22312

703 354-3350

Audio amp power supplies; ALC and AGC amps, compressor limiters AM; modulation controllers; RF remote control systems, coaxial switches; line sections; meter panels; meter jacks & plugs; DA equip; antenna monitors; RF generators; impedance bridges; phase meters; rectifiers, surge protectors, transformers; automatic power & modulation controls; RF ammeters; panel meters; ATS systems; RF receiver/generator; integrating buffer amps VS

DELTA ELECTRONICS INC DIV LONG ENGINEERING

961 Burke St Winston-Salem NC 27101
919 725-2306

Audio distribution & line amps; pre-amps, monitor amps; audio consoles (mixers, mono, stereo, quad, audio for TV, portable); complete audio studio construction; impedance bridges; radio & TV studio design; facility turnkey installation VS

DICTAPHONE CORP

120 Old Post Rd Rye NY 10580
914 967-6211

Telephone answering equip

DIELECTRIC COMMUNICATIONS DIV OF SOLA BASIC

Rte 121 Raymond ME 04071
207 655-4555

RF watt meters, RF loads, RF switchers; diplexers; waveguide & accessories; dehydrators VS

DIGITAL VIDEO SYSTEMS

716 Gordon Baker Rd Willowdale Ontario
Canada M2H3B4
416 499-4826

Time base correctors (helical capstan servo & non-servo, quad); frame & field synchronizers; digital noise reducers, dropout compensators, digital video effects devices; comb decoders; A/D, D/A converters VS
See ad cover 3—refer to rep dist section

DI-TECH INC

311 Wyandanch Ave N Babylon NY 11704
516 643-4040

Audio amps (distribution & monitor); tone generators; video pulse amps, routing switchers, signal equalizing systems, equalizers, video presence detectors VS

DOLBY LABORATORIES INC

731 Sansome St San Francisco CA 94111
415 392-0300

Noise reduction systems, audio compressor/limiters/filters, FM VS
See ad pg 150

DORROUGH ELECTRONICS

5221 Collier Pl Woodland Hills CA 91364
213 999-1132

AM & FM compressor/limiters/filters VS

DRANETZ ENGINEERING LABS

2385 S Clinton Ave S Plainfield NJ 07080
201 755-7080

Frequency monitors & counters, burst phase meters, voltmeters, millimeters, phase meters, diff phase-gain measurement VS

DUCA-RICHARDSON CORP — See Ampex

DUNCAN ELECTRONICS INC

2865 Fairview Rd Costa Mesa CA 92626
714 545-8261

Audio slide attenuator controls VS

DU PONT (EI DUPONT DE NEMOURS & CO)

MAGNETIC PRODUCTS DIV
Old Dupont Airport Site Wilmington DE 19898
302 999-4253

Videotape and video cassettes

DUNLAP CLARKE ELECTRONICS

94 Condor St East Boston MA 02128
617 569-1286

Audio amps (pre-amps, monitors, power & public address)

DURNELL ENGINEERING INC

PO Box 60 Hwy 4 S Emmetsburg IA 50536
712 852-2611

Aerial personnel lift trucks

DYMA ENGINEERING

PO Box 1697 Taos NM 87571
505 758-8686

Pre-amps; dist. line, monitor & power amps; ALC & AGC amps; AM compressor/limiters; FM compressor/limiters/filters; active equalizers & filters; special effects; reverb units; computer/microprocessor controllers; mono, stereo, quad, audio for TV & portable mixing consoles; complete disc consoles; intercom systems; dynamic mics; patch panels; complete studio construction; time-delay open reel player/recorders; routing switchers; videotape storage; time code gens/readers; audio/video recorder synchronizer; open-reel, cartridge, & cassette storage; remote control systems; RF switchers; master & slave clocks; time dist systems; audio generators; status & alarm indicators; auto TV monitors; equip rental; radio & TV studio design; surge protectors; mobile van construction VS
See ad pg 26

DYNAIR ELECTRONICS INC

5275 Market St San Diego CA 92114
714 263-7711

Video pulse, subcarrier & distribution amps; routing switchers; sync generators; black burst generators; spec effects generators; modulators, demodulators; equalizers, audio preamps, audio switchers, audio distribution amps VS
See ad pg 186, 195, 203, 209

DYNASCIENCES VIDEO PRODUCTS

Township Line Rd Blue Bell PA 19422
215 256-6420

Audio distribution amps; video character/graphics systems; encoded chroma keyers, image enhancers; amps (pulse, distribution, subcarrier); small production switchers; sync generator & color bar systems; two VTR editor-controllers; video identification systems; animation devices VS
See ad pg 77
NM C. Buzzard 801 Branding Iron SE
Albuquerque 87123..... 505 299-5323

DYNATECH DATA SYSTEMS

7644 Dynatech Ct Springfield VA 22153
303 569-9000

Auto time/weather announcers; coaxial & twin axial patching equip

DYTEK INDUSTRIES INC

2492 W 2nd Ave Denver CO 80223
303 935-3514

Production switchers, routing switchers, automated switchers, special effects generators, chroma-keyers, edit controllers VS

E

EASTMAN KODAK CO MOTION PICTURE & AUDIOVISUAL MARKETS DIV

343 State St Rochester NY 14650
716 724-4000

Motion picture cameras; motion picture film; projectors for TV; film processors VS
See ad pgs 124-125

ECHO SCIENCE (ARVIN/ECHO)

485 E Middlefield Rd Mountain View CA 94043
415 961-7145

Electronic cassette disc; frame & field synchronizers; segmented-helical, automated, disc VTRs; VTR head refurbishing; two VTR editor-controller (disc); video action recorders (disc; slo mo, variable speed, time lapse); electronic still stores; comb decoders; A/D converters; weather radar systems VS
See ad pgs 64-65—refer to rep dist section

ECONCO BROADCAST SERVICE INC

1302 Commerce Ave Woodland CA 95695
916 662-4495

Power tube repair/rebuilding VS

continued on page 116

CREATIVE FREEDOM

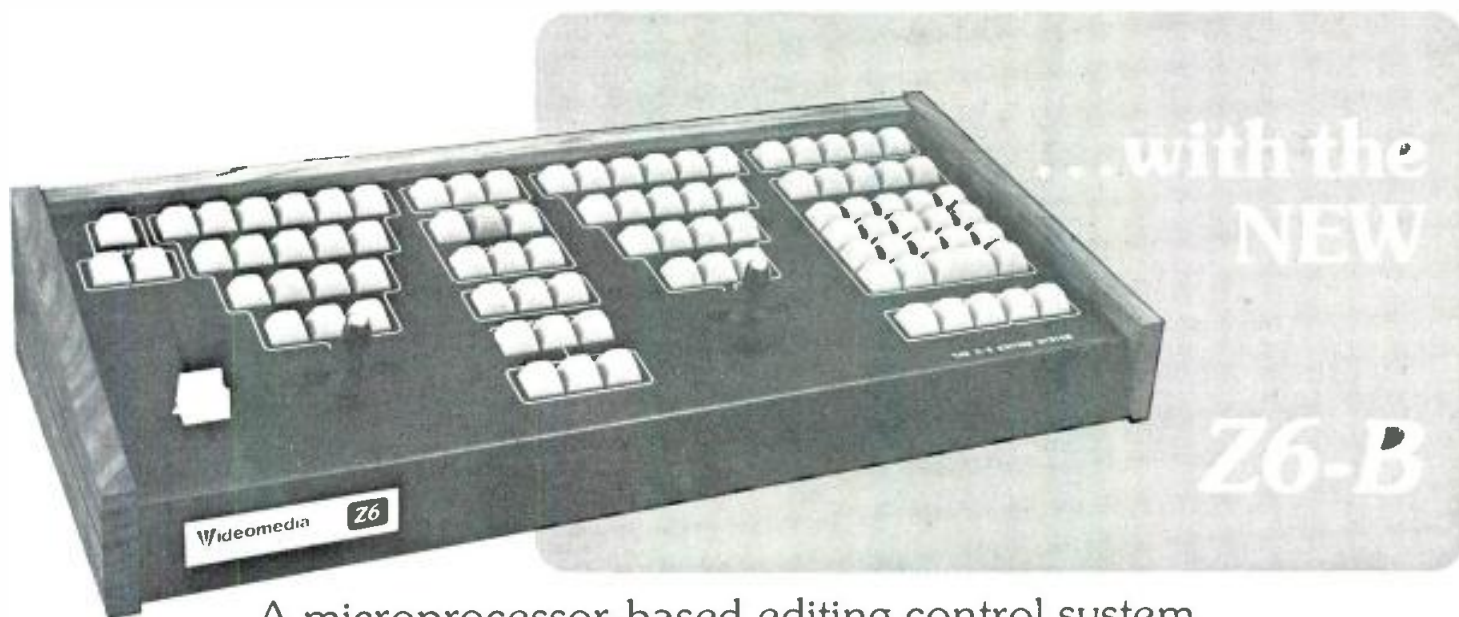

A microprocessor-based editing control system

Who more than you, deserves all this?

The Z6/B has all of the outstanding features of its predecessor, the Z6/A plus . . .

- **Auto Edit** — any or all 99 events can be performed at the push of a single button.
- **Sync** — a Z6 exclusive, keeps both tapes synchronous with respect to each other. Move either tape in either direction and the other transport will move the exact number of frames.
- **ADR** — Automatic Data Replacement, when activated, sends the editor in a "looping" condition. The operator can replace data numerous times until it is a "take."
- **Auto Cal** — automatically assigns the proper number to the proper frame of video on any new tape. No longer do known locations or SMPTE addresses need to be referenced.

Z6/B standard features include . . .

- Bi directional joystick shuttle
- Auto search
- 99 event memory
- Full status display
- Cruise control
- Rehearse, perform, review edit
- Error and prompting message
- Programmable Pre and Post rolls
- Single glide ballistics
- NO mechanical mods to VTR's
- SMPTE or Micro-code display
- Return to "in" or "out" points
- Micro-loc* — frame accuracy
- Consecutive non stop mode change
- Full VTR remote control
- A/B monitor select
- Tag functions

Z6/B options include . . .

- Drop frame/Non drop frame readout
- Dump — an exclusive Z6 feature which records all memory on the video tape itself
- Line Printer — allows a hard copy read-out of all edit decisions and parameters

Z6 is truly the most powerful video tape editing system available. Call Videomedia or your local dealer for more information.

*pat. pend.



The Z6 data display is a continuous readout of all edit parameters, including operator prompting messages.

Videomedia
Professional Television Systems

250 North Wolfe Road, Sunnyvale, CA 94086 408/733-6500

Circle 267 on Reader Service Card

Get the most from your AM signal...

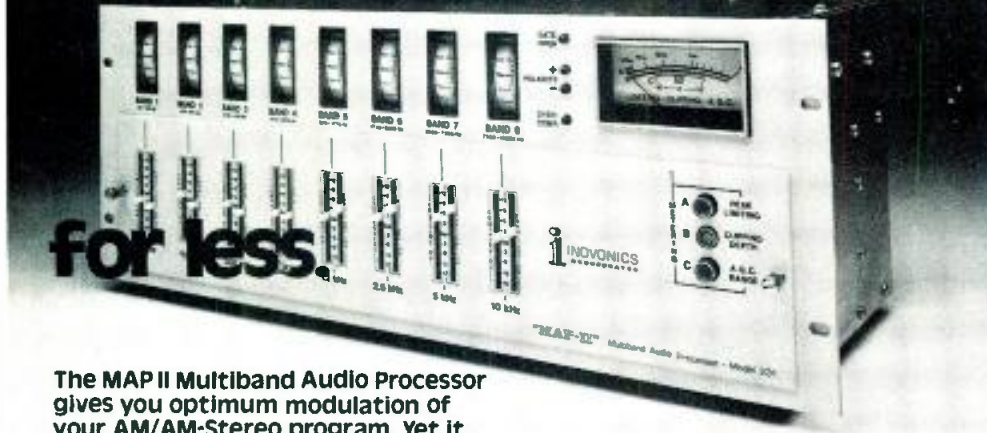

for less.

The MAP II Multiband Audio Processor gives you optimum modulation of your AM/AM-Stereo program. Yet it costs much less than similar systems.

Discriminate Compression
Only MAP II offers you independent compression and equalization for each of eight bands. Input level is held constant by a slow, gain-riding A.G.C.

Inaudible Phase Optimization
Program phase is silently "rotated" for maximum positive modulation.

Absolute Peak Control
A unique integrated peak controller combines a hard clipper with a low-distortion peak limiter.

Convenient Operation
Features include selectable low- and high-pass filters, "proof" mode, and built-in pink-noise generator.

Call or write today for more information. Map II — \$1670.

Inovonics Inc.

503-B Vandell Way
Campbell, CA 95008

Telephone
(408) 374-8300



Circle 168 on Reader Service Card

The Source '79

EDCO PRODUCTS INC
680 Blizzell Dr Lexington KY 40504
606 259-0434
Stereo phase enhancers; audio cassette player/recorder, audio distribution amps; video pulse & distribution amps, routing switchers VS

EDCOR DIV OF PAC
16782 Hale Ave Irvine CA 92714
714 556-2740

Audio amps (distribution, line, pre-amps, public address); microphones (condenser, wireless, lavalier); headphone amps; remote control systems

EDISON ELECTRONICS—See McGraw-Edison

EDUTRON INC
Suite 1 25 Oak St Roswell GA 30075
404 992-1626

Video image enhancers, digital noise reducers/filters, processing amps; time base correctors; auto skew correctors VS

EECO
1601 E Chestnut Ave Santa Ana CA 92701
714 835-6000

(SEE AMPLEX) Audio & video tape editing equip; character generators, synchronizing equip VS

EEV INC
7 Westchester Plaza Elmsford NY 10523
914 592-6050

RF tubes; vacuum tubes; camera pickup tubes; rectifiers; surge protectors; vacuum capacitors; klystrons, Leddicons; digital clocks; character/graphics displays VS

See ad pg 197

GA	H Kozicki 15 Dunwoody Park Ste 100E Atlanta 30338	404 394-9201
KY	R Bossert 18 Indian Hill Rd Union 49101	606 384-4477
MA	D Green 3 Buckingham Rd Natick 01760	617 653-8300
TX	R Knowles Rt 1 Anna 75003	214 837-2464
WA	D Rose 19001 40th Pl NE Seattle 98155	206 363-2200

EEV CANADA LTD
67 Westmore Drive Rexdale Ontario M9V 3Y6
416 745-9494

RF tubes, vacuum tubes, camera pickup tubes, rectifiers, surge protectors, vacuum capacitors; klystrons, Leddicons; digital clocks; character/graphics displays VS

EG&G
35 Congress St Salem MA 01970
617 745-3200

Obstruction lighting; tower lighting VS
See ad pg 96

EIDSON ELECTRONIC CO
PO Box 96 Temple TX 76501
817 773-3901

Quartz crystals for frequency control VS

EIGEN VIDEO
PO Box 1027 Grass Valley CA 95945
916 273-1341

Color floppy disc recorder (slo mo, variable speed, time lapse); animation devices; helical capstan servo TBCs VS
See ad pg 194

EIMAC DIV OF VARIAN
301 Industrial Way San Carlos CA 94070
415 592-1221

Complete line of broadcast, quality power grid tubes (triodes, tetrodes, pentodes) VS
See ad pg 29

AZ	Varian 7117 Third Ave Suite 106 Scottsdale 85251	602 947-5461
CA	Varian 4940 El Camino Real Los Altos 94022	415 968-7630
	Varian 2901 Wilshire Blvd Suite 102 Santa Monica 90430	213 828-5588
FL	Varian 314 S Missouri Suite 307 Clearwater 33516	813 446-8513
GA	Varian 1115B Watson Blvd Warner Robins 31093	912 923-6387

Follow
the
Network Leaders

SPECIFY

SILVERCEL BATTERIES

by **Yardney**

- Ideal For Electronic News Gathering ...Cameras And VTR Equipment
- 3 Times The Power...Much Less Weight

The accepted standard of excellence, Yardney Silvercels are LIGHTER but MORE POWERFUL. Many more running hours are built into Silvercels than any other system of comparable size and weight.

QUICK CHARGE when needed without battery damage. No discharge memory problems. Your camera will never be out-of-service because of charging problems.

Selected by original camera manufacturers and in demand as replacement batteries everywhere. Write for catalog.

Yardney

ELECTRIC CORPORATION
82 Mechanic Street
Pawcatuck Connecticut 06379
(203) 599-1100

Circle 169 on Reader Service Card

	Varian 665-Powers Ferry Rd NW Suite 100 Allanta 30339.....	404 955-1397
IL	Varian 205 W Touhy Ave Park Ridge 60068.....	312 825-6686
MA	Varian 400 Totten Pond Rd Bldg 1 Waltham 02154.....	617 890-4560
MD	Varian 4701 Lydell Rd Cheverly 20781.....	301 773-7010
NJ	Varian 306 Fellowship Rd Mt Laurel 08054.....	609 235-6800
	Varian 25 Rte 22 Springfield 07081.....	201 376-6600
NY	Varian 6489 Ridings Rd Syracuse 13206.....	315 437-2568
OH	Varian 4134 Linden Ave Suite 101 Dayton 45432.....	513 258-3930
TX	Varian PO Box 689 558 S Central Expy Suite 202 Richardson 75080.....	214 235-2385
CAN	Varian 45 River Dr Georgetown Ontario L7G 2J4.....	416 457-4130

EIP MICROWAVE

3230 Scott Blvd Santa Clara CA 95051
408 244-7975

Microwave and FM frequency counters and monitors VS

E.L.C.O. ENGINEERING

PO Box 10432 Santa Ana CA 92711
714 544-5760

Audio processing equip (ALC and AGC amps, AM & FM compressor/limiters, WBL); tone generators; RF amps, receivers, comm & monitor; loop ants; frequency monitors and counters; facility turnkey installation; EBS two-tone systems VS

ELECTRA CO DIV OF MASCO OF INDIANA

300 E County Line Rd Cumberland IN 46229
317 894-1440

Automatic scanning monitors

ELECTRO CONTROLS INC

2975 So 300 West Salt Lake City UT 84115
801 487-9861

Lighting heads, stands & fixtures; manual & automated light control systems & dimmer packs; patch terminals, plugs and connectors VS

ELECTROHOME LTD

809 Wellington St N Kitchener ON CAN N2G 4J6
519 744-7111

Color & b&w monitors, pay-TV descramblers; large screen projectors

ELECTRO IMPULSE INC

PO Box 870 Red Bank NJ 07701
201 741-0404

AM/FM/TV dry loads, cooling systems, RF attenuators; wattmeters VS

See ad pg 208

ELECTRONEERING INC

PO Box 85 Selma NC 27576
919 284-4928

Digital timers; radio equip. sales

ELECTRONIC DEVICES INC

21 Gray Oaks Ave Yonkers NY 10710
914 965-4400

Solid state rectifiers, replacements for vacuum tubes

ELECTRONIC MUSIC LABORATORIES

PO Box H Vernon CT 06066
201 875-0751

Music synthesizers

ELECTRONICS DIVERSIFIED

1675 NW 216th St Hillsboro OR 97123
503 645-5533

Studio light controls; patch panels

ELECTRONICS MISSILES & COMMUNICATIONS INC

PO Box 68 White Haven PA 18661
717 443-9575

RF amplifiers; FM and TV/translators; UHF and VHF TV transmitters; HP and CP TV antennas

ELECTRO & OPTICAL SYSTEMS LTD

3015 Kennedy Rd Scarborough Ontario M1V 1E7
416 291-4492

PPM level indicators; remote control camera mounts; alphanumeric generators; color

mounts; alphanumeric generators; color correctors; b&w, color & DC portable picture monitors; TV mono cameras; small production switchers; post production switchers; routing switchers; audio/video recorder synchronizers; time code gens/readers; RF demodulators & modulators (Barco); vectorscopes; waveform monitors & analyzers; TV studio design; mobile van construction; facility turnkey installation VS

ELECTRO SOUND INC

160 San Gabriel Dr Sunnyvale CA 94086
408 245-6600

Tape auto loaders, splicing blocks, open-reel tape recorders, (portable and studio), tape duplicators

ELECTRO-VOICE INC

600 Cecil St Buchanan MI 49107
616 695-6831

Mics (dynamic, condenser, shotgun, lavalier); mic booms and dollies, accessories; speakers VS

See ad pg 143

CA E-V West 7473 Ave 304 Visalta 93277.....

209 625-1330
CAN E-V 345 Herbert St Gananoque Ontario.....

613 382-2141

ELPA MARKETING INDUSTRIES INC

Atlantic & Thorens Aves New Hyde Park NY 11040
516 746-3002

Turntables (Thorens)

EMCOR PRODUCTS

1600 4th Ave NW Rochester MN 55901
507 289-3371

Racks and cabinets VS

EMS INC

PO Box 2792, 17887 Mayflower Dr Castro Valley CA 94546
415 886-3348

Audio monitor amps; AM compressor/limiters; open-reel electronic tape editing equip & accessories; two VTR editor controller & computer-assisted VTR editing system VS

ENGLISH ELECTRIC VALVE CO — see EEV

ENCLOSURE CORP

4529 Adams Circle Cornwells Hts PA 19020
215 638-9550

Racks and cabinets

E-N-G CORPORATION

10009 C Shary Cir Concord CA 94518
415 798-4060

ENG microwave equip, supports, mobile van construction VS

VS MEANS IT'S VERIFIED

ENTERPRISE ELECTRONICS CO

PO Box 1216 Ind Blvd Enterprise AL 36330
205 347-3478

Weather radar systems

ESC ELECTRONICS

534 Bergen Blvd Palisades Pk NJ 07650
201 947-0400

Delay lines, RF filters VS

ESE

142 Sierra St El Segundo CA 90245
213 322-2136

Digital clocks, programming devices, timers, tape timer; LED VU meter. VS

See ad pg 196—refer to rep/dist section

EVENTIDE CLOCKWORKS INC

265 W 54th St New York NY 10019
212 581-9290

Audio phase controllers; audio compressor/expander/limiters; audio digital delay lines; audio flanger, pitch changer, microprocessor controllers, special effects, reverb units; real-time spectrum analyzer; mono-stereo matrix unit w. noise reduction VS

E-Z WAY PRODUCTS INC

PO Box 22845 Tampa FL 33622
813 677-7144

Towers

Dymek AM5 Tuner: Worth Talking About



Here's what your colleagues say about our new AM5 tuner monitor:

“ In regard to ... the operation of the AM5 tuner we purchased this past year, the program, production and news staff have been ecstatic. With the AM5 we can show “off air” response up through 15,000 Hz and there is almost no discernable difference when switching monitors from “off console” to “off air.” ... I am well pleased ... ”

Carl A. Lewis
Chief Engineer

KLMS Radio, Lincoln, Nebraska

“ I am pleased to report that the (AM5) units perform superbly ... When the DA5 antenna was connected and ... adjusted properly, all interference was reduced and the background noise was almost as low as an FM station. ”

Arthur F. Marko
AM Engineering Supervisor
WOR Radio, New York

“ We are exceedingly pleased with our AM3 and AM5 tuner. The output quality and separation, etc. are excellent ... We have used your tuners extensively for monitoring and recording, and have found them to be superior to anything else that we used in the past. ”

Harry H. Curtis
Manager Technical Operations
American Broadcasting Company

The AM5 is an excellent inexpensive AM monitoring tuner. That's why 35% of Dymek sales are to radio stations. Special features such as less than 1% distortion, the best ceramic filters, solid state construction, and the 150-600 ohm option have made the AM5 the choice of AM broadcasting stations in the U.S. and Canada.

Try the AM5 Receiver and its Companion DA5 Antenna on a 30 day trial basis. Call toll free.

800/854-7769
Calif: 800/472-1783



Local 714/621-6711 TWX 910-581-4990



McKay Dymek Co
111 South College Ave
PO Box 5000
Claremont CA 91711

Circle 170 on Reader Service Card

SAVE MONEY AND ENERGY TOO!

BUY YOUR ONE KILOWATT SOLID STATE AM TRANSMITTER FROM SINTRONIC

You get all the energy savings and improved reliability that solid state technology guarantees and a transmitter loaded with extra features. The circuitry is on 27 front-access plug-in cards (even the PA). Panel meters and a digital multimeter monitor all critical circuitry. It has synthesized frequency control, and 125% positive-peak modulation capability. The output power is monitored and *automatically* maintained at the correct output power. Remote control capability, a switchable 7.5 kHz low pass filter and negative peak clipper are standard.

You will like our price too!

Sintronic

212 Welsh Pool Road,
Lionville, PA. 19353 (215) 363-0444.

CORPORATION

SEE US AT THE NRBA — BOOTH 515/517
Circle 171 on Reader Service Card

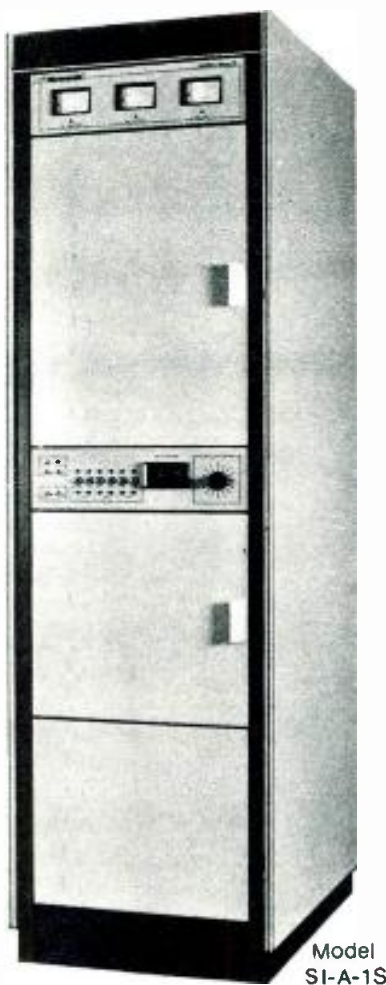

Model SI-A-1S

THE SUPER SYSTEM



PHASE III

RTS Systems introduces an innovative new intercom system for teleproduction communications in studio and field. With *Super System Phase III*, we've incorporated a number of advances which mark a significant increase in product versatility.

Our new design features the portability of 12 volt battery power and the convenience of dry-line operation. The system can be arranged with up to 50 various user stations on line, and may be coupled to existing communications lines using our new RTS interface devices.

Phase III offers impressive capabilities like powerful headphone amplification, two (or more) channel operation, microphone level limiting, and stable sidetone level. The new units are handsomely packaged and completely field serviceable.

With increased flexibility, improved circuitry, and greater reliability, our *Super System* represents a new development in meeting the demands of modern teleproduction. For additional information, contact RTS Systems, Inc.

RTS
Systems INC.

1100 WEST CHESTNUT STREET, BURBANK, CALIFORNIA 91502 213/843-7022

Circle 172 on Reader Service Card

The Source '79

F

FARINON

1680 Bayport Ave San Carlos CA 94070
415 595-3500

RF demodulators; duplexers, exciters, modulators; microwave STLs; microwave equip. (intercity, portable, ENG); receive-only satellite earth stations VS

YVES FAROUDJA INC

199 First St Los Altos CA 94022
415 991-3555

Video image enhancers; video filters; comb decoders VS

F&B CECO INC

315 W 43rd St New York NY 10036
212 974-4600

Manufacture & rental of motion picture projectors, lighting equip, sound equip, editing equip, tripods & accessories, carrying cases VS

FERNSEH GROUP ROBERT BOSCH CORP —
See Bosch Fernseh

FIDELIPAC

109 Gaither Dr Mt Laurel NJ 08057
609 235-3511

Magnetic tape carts, cartridge parts, cassettes; splicing blocks & tape; alignment gauges, bulk erasers; tape cartridge storage; audio & videotape bulk erasers; on-air lights; wow & flutter meters; hot tape; precision calibration alignment tapes; lubricated cartridge tapes VS
See ad pg 18, 134

FILMLINE CORP

43 Erna St Milford CT 06463
203 878-2433

Film processors

IMERO FIORENTINO ASSOC INC

10 W 66th St New York NY 10023
212 787-3050

TV color contrast evaluator kit; TV monitor analyzer kit; set design; dealers for 3M scanamurals; TV studio design consultants; lighting direction & consultation; production design, direction & supervision; seminars on TV lighting & staging techniques; production support services VS

FISHER BERKELEY CORP

5800 Christie Ave Emeryville CA 94608
415 655-9696

Intercom systems; PA amplifiers, power supplies

FISHER-BURKE

PO Box 2468 Phoenix AZ 85003
602 257-0225

Complete line of audio products VS

VS MEANS IT'S VERIFIED

FIXTUNE ELECTRONICS INC

1 W 30th St New York NY 10001
212 695-4767

One station crystal controlled FM receivers; SCA receivers; EBS receivers VS

FLASH TECHNOLOGY CORP OF AMERICA

55 Lake St Nashua NH 03060
603 883-6500

Strobe beacons for towers, beam elevation adjustment brackets

JOHN FLUKE MFG CO

PO Box 43210 Mountlake Terrace WA 98043
206 774-2211

Frequency monitors & counters; audio & RF generators; voltmeters, multimeters; dB meters; multitest systems; tape loggers, log printers VS

FORGFLO CORP BRUSH MAGNETIC HEADS DIV

Third & Regan St Sunbury PA 17801
717 286-5611

Magnetic recorder heads



FORT WORTH TOWER CO INC
 PO Box 8597 Fort Worth TX 76112
 817 457-3060
 Towers, prefab bldgs. earth stations

FREELAND PRODUCTS CO
 3233 Conti St New Orleans LA 70119
 504 822-9222
 Rebuilt vacuum tubes

FREQUENCY DEVICES INC
 25 Locust St Haverhill MA 08130
 617 374-0761
 Audio amplifier power supplies, active equalizers & filters; tone generators; noise reduction systems; audio generators

FREZZOLINI ELECTRONICS INC
 7 Valley St Hawthorne NJ 07506
 201 427-1160
 Cine cameras, carrying cases; magnetic recording equipment & accessories; batteries, battery chargers; power packs for portable video cameras
 See ad pg 170

FUJI PHOTO FILM MAGNETIC TAPE DIV
 350 Fifth Ave New York NY 10001
 212 736-3335
 Videotape; audio tape and cassettes
 See ad pg 175

CA	S Henderson & M Brehn 1211 E Artesia Blvd Carson 90746	213 636-0101
IL	J Walsh & D Corrigan 610 Bonnie Ln Elk Grove 60007	312 569-3500
TX	S Rissetter 3500 Garden Brook Dr Dallas 75234	214 243-2537

FUJINON OPTICAL
 672 White Plains Rd Scarsdale NY 10583
 914 472-9800
 Television and film camera lenses and accessories

FUNG ENGINEERING CO
 PO Box 1082 San Carlos CA 94070
 415 592-8434
 RF demodulators and modulators

G

GABRIEL ELECTRONICS
 PO Box 626 Scarborough ME 04074
 207 883-5161
 Parabolic, horn & shrouded antennas; elliptical waveguides, tower construction equip; transmission lines & connectors; facility turnkey installations; DA equip; receiving antennas

GARNER INDUSTRIES
 4200 N 48th St Lincoln NE 68504
 402 464-5911
 Tape duplication systems; conveyor-type tape erasers; bulk erasers

GARDNER COMMUNICATIONS CORP
 1980 S Post Oak Rd Ste 2040 Houston TX 77056
 713 961-7348
 Transmit/receive & receive-only satellite earth stations

GATES BROADCAST DIVISION—See Harris Corp.

GAW CO INC
 53 S Jefferson Rd Whippany NJ 07981
 201 887-7210
 Frequency monitors and counters, audio generators, voltmeters, harmonic distortion meters, EBS two tone systems

GBC CLOSED CIRCUIT TV CORP.
 315 Hudson St New York NY 10013
 212 989-4433
 TV cameras, studio & portable (b&w & color); camera mounts; telecine chains; monitors; sync gens; spec effect gens; coaxial connectors; video distribution amps, pulse distribution amps

GENERAL CAMERA CORP
 471 11th Ave New York NY 10018
 212 594-8700
 Cine cameras; camera accessories; film magnetic recording equip

GENERAL ELECTRIC CO LIGHTING BUSINESS GROUP
 Nela Park Cleveland OH 44112
 216 266-2092
 Stage, studio, TV lamps

GENERAL ELECTRIC CO VIDEO DISPLAY EQUIP OPERATION
 Electronics Pk 6-206 Syracuse NY 13221
 315 456-2562
 Large screen video projectors

GENERAL TELEVISION NETWORK
 13225 Capital Ave Oak Park MI 48237
 313 548-2500
 Production facilities, post production services, TV equip repair service, studio TV design, video tape/film recording transfer

GLASSMAN HIGH VOLTAGE INC
 PO Box 551 Whitehouse Sta NJ 08889
 201 534-2226
 DC power supplies, power displays, TV, flying spot scanners

GLOBE UNION INC BATTERY DIV
 5757 N Green Bay Ave Milwaukee WI 53201
 414 228-2581
 Batteries, battery charges

GOLDMARK COMMUNICATIONS CORP
 98 Commerce Rd Stamford CT 06904
 203 327-7270
 Film to video transfer systems; tape duplication

ALAN GORDON ENTERPRISES INC
 1430 N Cahuenga Blvd Hollywood CA 90028
 213 466-3561
 Dist of full line cine production equip; tripods (FOBA); RF mics (Swintek); director's viewfinder; animation motors (NCE); grip equip; film projectors
 See ad pg 208

GORMAN-REDLICH MFG CO
 6 Curtis St Athens OH 45701
 614 593-3150
 Antenna monitors, phase meters, EBS two tone systems, weather receiver

eliminates the source of EMI noise.

"Extreme corrosion of steel guys and electromagnetic interference, due to arcing, were two very severe problems when we purchased WYFR.

"We installed PHILLYSTRAN on all nine broadcast antennas at Hatherly Beach, eliminating the source of EMI noise.

"We were pleasantly surprised by the ease of re-guying and the way PHILLYSTRAN reduced the labor involved to make our non-metallic guying systems competitive —on an installed-cost comparison—to conventional metal guys."

See US at NRBA Booth 502 Oct 7-10

Art Thompson, Station Manager
 WYFR, The International Voice of Family Radio
 Scituate, Mass.

PHILLYSTRAN™ Tower Guys are
 • non-conducting • maintenance-free • easy-to-install

Please send

- "10 reasons why your best buy for tower guys is PHILLYSTRAN"
- "PHILLYSTRAN offers the advantages of synthetic fibers...plus the strength of steel"

NAME _____
 TITLE _____
 COMPANY _____
 ADDRESS _____
 CITY _____
 STATE _____ ZIP _____



PHILADELPHIA RESINS CORP.
 20 Commerce Drive
 Montgomeryville, PA 18936
 (215) 855-8450
 Telex 84-6342

BM/E

Circle 173 on Reader Service Card

BM/E SEPTEMBER, 1979 119

Comrex Corporation Manufactures

Wireless Microphones:

Our 450 MHz system is THE ENG broadcast standard.

Cue Systems:

The ideal way to direct ENG field personnel. This 1 watt IFB system allows ENG crew to hear both program and instructions in one pocket receiver.

TV Aural Monitors:

Rugged pocket receivers fixed to your TV channel for live off-air cueing. From 50-500 MHz.

Low Frequency Extenders:

A new category of broadcast equipment. Broadcast quality on a standard dial telephone line. If you broadcast news, sports, weather, farm, stock market, religious, or special interest programs, THIS IS A MUST-KNOW!

For further information, call or write:

COMREX
18 Years In Broadcasting
PO Box 269
60 Union Avenue
Sudbury, Massachusetts 01776
TEL: (617) 443-8811
TWX 710 347-1049

Circle 174 on Reader Service Card

The Source '79

GOTHAM AUDIO CORP
741 Washington St New York NY 10014
212 741-7411

Condenser, shotgun, lavalier mics (Neumann); booms and dollies, accessories (Neumann); audio disc cutting equip (Neumann); test records; reverberation units (EMT); audio recorder/players; logging recorder (Telefunken); compressor/limiters (EMT); equalizers and filters (NTP) broadcast turntables (EMT); pick-up cartridges (EMT); tape timers; flutter meters (Woelke); phase meters (Neumann); audio attenuators (Danner); polarity testers; rumble meters (Neumann); digital audio delay unit; monitor speakers (K&H); wire & cable (EMT); input transformers (Beyer); noise reduction system (Telefunken); peak reading and VU meter (NTP) VS

GOULD INC
2050 Cabot Blvd W Langhorne PA 19047
215 752-0555

Batteries, battery chargers; emergency power equipment

GRALEX INDUSTRIES DIV
155 Marine St Farmingdale NY 11735
516 694-3600

Digital voltmeters VS

GRANDY INC
1275 Bloomfield Ave Bldg #1 Fairfield NJ 07006
201 575-1433

Magnetic heads, relapping service-heads, high speed duplicating heads

GRASIS CORPORATION
PO Box 1039 Kansas City MO 64141
816 483-1100

Broadcast, CATV, microwave towers; molded fiberglass head-end buildings

THE GRASS VALLEY GROUP INC
PO Box 1114 Grass Valley CA 95945
916 273-8421

Video chroma keyers (RGB and encoded); processing amps; pulse and distribution amps. subcarrier amps; large & small production switchers, automated production switcher with effects memory; auto master control systems; post-production switchers; routing switchers; SEGs; sync & blackburst & single line generator systems; frame synchronizers; digital video effects, colorizers, repositioners, compressors; isophasing & equalizing amps VS

See ad pgs 7, 22, 189

CA	GVG 4419 Van Nuys Blvd Suite 307 Sherman Oaks 91403.....	213 990-6172
GA	GVG 1644 Tullie Cir NE Suite 102 Atlanta 30329.....	404 634-0521
IN	GVG 810 W Bristol St Suite E Elkhart 46514.....	219 264-0931
MIN	GVG 3585 N Lexington Ave Suite 374 Arden Hills 55112.....	612 483-2594
NY	GVG Station Plaza E Great Neck 11021.....	516 487-1311
TX	GVG 2639 Walnut Hill Ln Suite 143 Dallas 75229.....	214 358-4229

GRAY ENGINEERING LABS
504 W Chapman Ave Suite 0 Orange CA 92668
714 997-4151

SMPT time code systems, videotape time code gens/readers VS

GREGG LABORATORIES
2120 E Howell #505-506 Anaheim CA 92806
714 937-1100

AM & FM compressor/limiters; active equalizers and filters

THE GREAT AMERICAN MARKET
PO Box 178 Woodland Hills CA 91364
213 883-8182

Lighting heads, stands, fixtures, light projected patterns, special effects, fresnels, control systems VS

GRINNAN FIXTURE CO
16041 Georgetown St NE, Minerva OH 44657
216 862-2323

Studio cabinets & furniture; complete studio construction; open reel & cartridge tape storage;

racks & cabinets; finance services; mobile van construction; facility turnkey installation; building & remodeling plans

GROTON COMPUTERS INC
19 Fort Hill Rd Groton CT 06340
203 445-2325

Log printers; radio computer business services VS

GRUBER PRODUCTS CO
5254 Jackman Rd Toledo OH 43613
419 476-7200

Mobile ENG carts, projection tables VS

GTE LENKURT INC
1105 Country Rd San Carlos CA 94070
415 595-3000

Microwave STLs; microwave radio equip; remote control systems; RF program subcarriers VS

GTE SYLVANIA (LIGHTING PRODUCTS GROUP)
100 Endicott St Danvers MA 01923
617 777-1900

Studio, theatre & TV lights, accessories

GYR PRODUCTS/GDETICS INC
1335 So Claudina St Anaheim CA 92805
714 772-1000

Time lapse VTR

H

HALLIKAINEN & FRIENDS

101 D4 Suburban Road San Luis Obispo CA 93401
805 541-0200

Auto loggers; auto time/weather announcers; audio consoles for TV; remote control systems VS
See ad pg 122—refer to reprodist section

HAMMOND INDUSTRIES
155 Michael Dr Syosset NY 11791
516 364-1900

Stereo disco mixers (Meteor); power amps (Meteor); speakers (Meteor), speaker overload protectors (Meteor); sound-to-light controllers, lighting units, light projectors (Meteor); equalizers, (Klark-Teknik); audio test unit; audio response analyzer (Ferroglyph); equipment racks and shelving (Click Systems)

HARRIS CORP BROADCAST PRODUCTS DIV
PO Box 4220 Quincy Il 62301
217 222-8200

AM, FM & TV transmitters; RF demodulators, diplexers, exciters, modulators, amps, switchers, cables; FM & TV translators; SCA equipment: full line of radio automation equipment: AM, FM & TV antennas and accessories: TV studio, studio/field convertible, & ENG/EFP cameras; tripods, heads & accessories; remote control mounts; color correctors & encoders; proc, pulse & dist. amps; dist., line, monitor, power audio amps, power supplies; ALC & AGC amps, AM & FM compressor/limiters; active & passive equalizers & filters; turntables, pickup arms, turntable pre-amps & controls; single & dual audio cart player/recorders; cine cameras, lenses, tripods & accessories; facility turnkey installation VS
See ad pg 12

CA	Harris 5839 Green Valley Cir Ste 200 Culver City 90230.....	213 642-0052
DC	Harris 2600 Virginia Ave NW Washington DC 20037.....	202 342-3946
NY	Harris 675 3rd Ave New York 10017.....	212 986-7600
TX	Harris 7000 Regency Sq Blvd Ste 200 Houston 77036.....	713 977-2411

HARRIS CORP SATELLITE COMM DIV ANTENNA OPERATIONS
2600 N Longview St Kilgore TX 75662
214 984-0555

Satellite earth ground terminals VS

HARRIS CORP SATELLITE COMMUNICATIONS DIV
PO Box 1700 Melbourne FL 32901
305 724-3000

Earth stations, towers, satellite & CATV receiving antennas VS



HARRISON SYSTEMS
Box 22964 Nashville TN 37202
615 834-1184

Consoles, (mixers, mono, stereo, quad); audio components: equalizers & filters (active); controllers, computer/microprocessor

HARWOOD MFG CO
1800 W Fullerton Chicago IL 60614
312 929-1100

Photographic & electronic lighting equip, portable lighting bars

HEATH CO
Benton Harbor MI 49022
616 982-3200

Intercoms; tape cartridge equip; speakers; oscilloscopes, multimeters; frequency counters; signal generators, AF & RF; distortion meters; impedance bridges; micro & mini computers & computer peripheral equip

HEWLETT-PACKARD CO
1501 Page Mill Rd Palo Alto CA 94304
415 856-1501

Oscilloscopes, frequency counters, waveform analyzers, digital multimeters, signal generators, sweep oscillators, spectrum analyzers, other test equip; audio & RF generators; impedance bridges; chart recorders; voltmeters; harmonic distortion meters; inter-modulation meters; phase meters; diff phase/gain meas VS

HICKOK INSTRUMENT CO
10514 DuPont Ave Cleveland OH 44108
216 541-8060

Frequency monitors & counters; RF & audio generators, impedance bridges; voltmeters, multimeters, RF wattmeters; oscilloscopes; video test generators for servicing VS

HIGH-LITE CORP
23 Selwyn Dr Greenville SC 29615
803 268-7702

Towers; emergency power equipment; mobile van construction

HITACHI DENSHI AMERICA LTD
175 Crossways Park West Woodbury NY 11797
516 921-7200

Studio & portable color & mono video cameras; video monitors; one-inch TypeC VTRs; ENG microwave equip; oscilloscopes; waveform monitors and analyzers; camera pick-up tubes VS
See ad pg 11

CA	Hit 21015 S Figueroa St Carson 90745	213 328-2110
CO	Hit 3538 Peoria Bldg 3 Ste 505 Aurora 80010	303 344-3156
GA	Hit 3610 Clearview Pkwy Doraville 30340	404 451-9453
IL	Hit 1725 N 33 Ave Melrose Pk 60160	312 344-4020
TX	Hit 14169 Proton Rd Dallas 75240	214 233-7623
WA	Hit 1051 Andover Pk W Tukwila 98188	206 575-1680

HM ELECTRONICS INC
6151 Fairmont Ave San Diego CA 92120
714 280-6050

Wireless mic systems; audio mixers VS

VS MEANS IT'S VERIFIED

HOLLAND ELECTRONICS INC
970 E 92nd St Brooklyn NY 11236
212 649-7330

Audio amps (line, monitor, power); pre-amps; op-amp modules; consoles (mixers, quad, audio for TV); headphones; intercom systems

HOLLOGON OPTICAL SYSTEMS CORP
225 Park Ave S New York NY 10003
212 260-2150

Film projectors (motion pic, flickerless, non-intermittent, variable speed or sync)

HOUSTON FEARLESS 76 INC
833 E Walnut St Carson CA 90746
213 770-4715

8, 16, 35 mm film processors, pollution control & silver recovery systems

HOUSTON PHOTO PRODUCTS INC
655 E 20th St Yuma AZ 85364
602 782-3677
Film processors

HOWE AUDIO PRODUCTIONS INC
Box 383 Boulder CO 80306
303 494-4693

Mixing consoles VS

HUGHES MICROWAVE COMM PRODUCTS
PO Box 2999 Torrance CA 90509
213 534-2146

Intercity microwave equip; receive only satellite earth stations

HUGHEY & PHILLIPS INC
3050 N California St Burbank CA 91505
213 849-1104

Tower lighting, beacons, de-icers

HY-GAIN ELECTRONICS DIV OF TELEX
8601 NE Hwy 6 Lincoln NE 68505
402 467-5321

AM and FM antennas; towers; tower hardware & construction equip, tower lighting VS

IDEAL INDUSTRIES
1780 Becker Pl Sycamore IL 60178
815 895-5181

Wire, cable stripping equip

IGM DIV OF NORTHWEST TECHNOLOGY INC
4041 Home Rd Bellingham WA 98225
206 733-4567

Relay & time insertion sequencers, computer/microprocessor controllers, memory units, multi-cart machines, read-out displays, data input devices, auto loggers, tone generators, time/weather announcers, complete radio automation systems; intercom systems; dist of tape carts, single, dual & time delay cart player/recorders; multi-cart player/recorders; telephone coupling equip.; automated light control systems VS

See ad pg 188—refer to rep/dist section
CA E Dooley 21109 Santa Cruz Hwy Los Gatos 95030..... 408 353-1834
GA J Drummond 1925 Century Blvd Ste 4 Atlanta 30345..... 404 325-3726
WA C Peterson 1301 Fraser Ste A-12 Bellingham 98225..... 206 671-3970

IKEGAMI ELECTRONICS (USA) INC
37 Brook Ave Maywood NJ 07607
201 368-9171

Color studio cameras; studio/field convertible & ENG/EFP cameras; b&W cameras; camera accessories; sync generators; color encoders; detail correctors; phase controllers; b&w color picture monitors; small production switchers; telecine systems; auto color balance unit for telecines VS

See ad pgs 53, 158-159—refer to rep/dist section
CA Ikegami 19164 Van Ness Ave Torrance 90501..... 213 328-2814
TX Ikegami 330 N Belt E Ste 228 Houston 77060..... 713 455-0100

Thanks Mutual

"An overseas reporter is only as good as his ability to deliver clean sound to the tape editor back at network control. Mutual's reporters sound intelligent and, thanks to Comrex, superbly intelligible."



Dick Rosse, Director of Overseas Operations for Mutual with Mutual's overseas news pack, including a Comrex Low Frequency Extender. Thanks, Mutual, for taking Comrex along.

COMREX

18 Years In Broadcasting

PO Box 269
60 Union Avenue
Sudbury, Massachusetts 01776
TEL: (617) 443-8811
TWX: 710 347-1049

Circle 175 on Reader Service Card

AGAIN & AGAIN POTOMAC INSTRUMENTS IS

PRODUCT INNOVATION
1ST

- First** FCC Approved Antenna Monitor
- First** Harmonic Reading Field Strength Meter for Standard Broadcast Stations
- First** Digital Antenna Monitor
- First** Frequency Synthesized RF Generator with Coherent Detector for RF Bridge Applications
- First** Solid State Combination VHF Field Strength Meter and RF Generator
- First** Audio Generator with these Features: L&R Outputs, Stereo Matrix Switch, IM Signal Source, Signal Leveling, Precision Attenuators, Mike and Line Source Impedance, Balanced and Unbalanced Outputs
- First** Audio Analyzer with these Features: L&R Inputs, Auto Leveling and Auto Nulling THD Analyzer, IMD Analyzer, Wow and Flutter Meter, Stereo Phase Meter, Differential Gain Meter

CONTACT US NOW FOR DESCRIPTIVE LITERATURE ON OUR COMPLETE LINE OF BROADCAST INSTRUMENTATION.

POTOMAC INSTRUMENTS

932 PHILADELPHIA AVE.
SILVER SPRING, MD 20910
(301) 589-2662

Circle 176 on Reader Service Card

AUTOMATIC PROGRAM LOGGING

Keep Your Station's Log Automatically

- FCC acceptable logs • Design your own format



The H&F Program Logging System can automate the task of keeping accurate and easily readable program logs. The logs are printed as the programs are run so you know just what was aired and when. The system works with most existing automation systems including those by IGM, Schafer, Harris and Sparta. Call us about yours.

Hallikainen & Friends, Inc.

101 D4 Suburban Road, San Luis Obispo, CA 93401
(805) 541-0200



Circle 177 on Reader Service Card

The Source '79

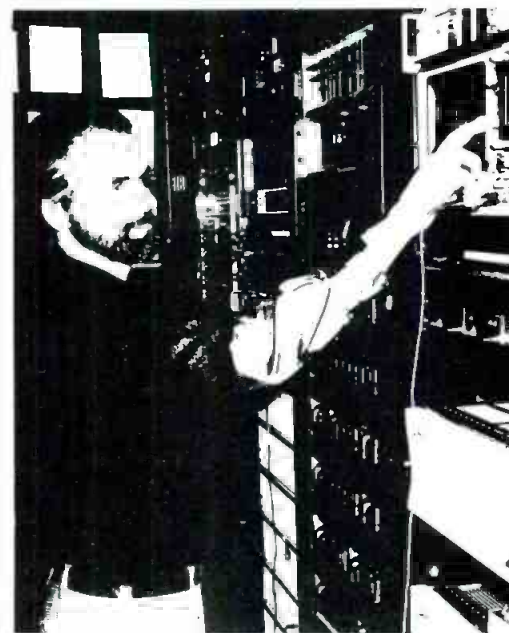

IMAGE DEVICES INC
1825 NE 149 St Miami FL 33181
305 945-1111

Portable audio mixer: headsets, headphones, intercom systems: lavalier condenser mic: tripods; ENG camera braces: color portable picture monitor; carrying cases (Samcine); magnetic recording equip & accessories; production equip rental; TV studio design; underwater housing for cine camera. other cine camera accessories VS

IMAGE MAGNIFICATION INC
739 Airway Cir New Smyrna Beach FL 32069
904 427-5294

Large screen TV projection systems VS

IMAGE TRANSFORM INC
4142 Lankershim Blvd N Hollywood CA 91602
213 985-7566

Videotape film transfers, scene by scene video correction, standards conversions VS

IMAGE VIDEO LTD
700 Progress Ave 16 Scarborough ON CAN M1H 2Z7

416 438-3940
Routing switchers: master control switchers; automated master control systems; small production switchers; SEGs

INDUSTRIAL ELECTRIC REELS INC
10102 F St Omaha NE 68127
402 339-9300

Cable reels & collector rings

INDUSTRIAL SCIENCES INC (ISI)
PO Box 1495 Gainesville FL 32602
305 373-6783/800 874-7590

Audio amps (distribution and pre-amps): consoles (mixers & stereo); encoded, luminance & RGB chroma keyers: video amps (pulse, distribution, subcarrier); large & small production switchers, SEGs; master control switchers; sync generator systems (color bar & black burst); auto telecine light control VS

See ad pgs 52, 97, 180—refer to rep/dist section

INNOVATIVE TELEVISION EQUIP (ITE)
Box 681 Woodland Hills CA 91367
213 888-9421

Heads for TV cameras, pedestals, stands, tripods, dollies; remote control mounts VS

INOVONICS INC
503-B Vandell Way Campbell CA 95008
408 374-8300

ALC & AGC amps: AM & FM compressor/limiters/filters; replacement tape recording electronics: constant tensioning kit for studio recorders; spectrum analyzers VS

See ad pg 116—refer to rep/dist section

INSTRUMENT LABORATORIES CORP
350 N Eric Dr Palatine IL 62067
312 358-8850
Test equip; cable locators; fault finders

INTERFACE VIDEO SYSTEMS
2033 M St NW #506 Washington DC 20036
202 857-0062
Videotape/film recording, transfer

INTERAND CORP
666 North Lake Shore Drive Chicago IL 60611
312 943-1200
Electronic video graphic systems, audio graphics,
interactive video educating devices

INTERNATIONAL AUDIO INC
2934 Malmo Dr Arlington Heights IL 60005
312 956-6030
Audio cassette tape duplicators; new audio
cassettes; tension and alignment gauges; new
3/4-inch video tape VS

INTERNATIONAL ELECTRO-MAGNETICS INC
350 N Eric Dr Palatine IL 60067
312 358-4622
Active audio equalizers and filters; tape heads
replacement

**INTERNATIONAL INSTRUMENTS DIV SIGMA
INSTRUMENT INC**
88 Marsh Hill Road Orange CT 06477
203 795-4711
Analog, VU & peak indicators, voltmeters, dB
meters

INTERNATIONAL MICROWAVE CORP
33 River Road Cos Cob CT 06807
203 661-6277
Microwave equip; STL & remote pickup, intercity,
portable, ENG VS

VS MEANS IT'S VERIFIED

INTERNATIONAL NUCLEAR CORP
608 Norris Ave Nashville TN 37204
615 254-3365
Audio amps (distribution, line, pre-amps, monitor);
tone generators; consoles (mixer, mono, audio for
TV, portable); RGB chroma keyers; video amps
(pulse, distribution, subcarrier); production
switchers (large & small); master control switchers,
post prod. & routing switchers; SEGs; signal
equalizing systems; digital video effects &
colorizers; equalizers, presence detectors; hum
bucking coils; EBS two-tone systems

INTERNATIONAL RECTIFIER CORP
233 Kansas St El Segundo CA 90245
213 322-3331
High power cartridge rectifier columns; solid state
tube replacements, rectifiers, surge protectors

INTERNATIONAL TAPETRONICS CORP
2425 S Main St Bloomington IL 61701
309 828-1381
Automated open-reel & multi-cart decks; cartridge
player recorders (single, dual, multiple, time delay)
See ad pg 16 VS

INTERNATIONAL VIDEO CORPORATION (IVC)
455 W Maude Ave Sunnyvale CA 94086
408 738-3900
Color studio cameras; studio/field convertible
cameras; ENG/EFP cameras; remote control
mounts; helical & segmented-helical VTRs VS

IONIC INDUSTRIES INC
128 James St Morristown NJ 07960
201 539-1040
Music synthesizers, sound effects

ISI—See Industrial Sciences Inc

ITI ELECTRONICS INC
PO Box 260 369 Lexington Ave Clifton NJ 07011
201 546-3900
Audio amps (line, pre-amps, monitor, power, power
supplies), audio rotary attenuators; passive
equalizers & filters; attenuators, fixed; telephone
coupling equip; line transformers; video AGC;
status & alarm indicators

continued on page 127



Modular tape components and electronics

Your Customized Tape System Source

If you are designing a tape system for broadcasting, industrial, medical, military or other professional installations, Telex tape components provide enormous design flexibility. These components, designed for heavy-duty applications, are made in U.S.A. guaranteeing the continuing availability of parts.

Complete information on all products is available. Write for details today.



Quality products for the audio professional



TELEX

9600 ALDRICH AVE SO., MINNEAPOLIS, MN 55420 U.S.A.
Telephone 612-884-4051, telex 29-7053

EUROPE: 22, rue de la Légion-d'Honneur, 93200 St Denis, France, Téléphone 820-98-46, telex 63-0013
CANADA: Telak Electronics, Ltd., 100 Midwest Road, Scarborough, Ontario M1P3B1, Telephone: 416-752-8575

Circle 178 on Reader Service Card

BME SEPTEMBER, 1979 123



RENICK



"We try to lessen human anxiety."

Ralph Renick is Vice President for Television News Operations, Wometco Enterprises, Inc., and may hold the record for years of service as news director of the same TV station. He's held that post at Wometco station WTVJ, Miami, for 29 years — which certainly qualifies him to speak knowingly about news gathering and news dissemination.

"Miami is one of the most competitive markets in America. We have good television news here and good newspapers. The standards are high, and the public has come to expect good performance. Competition is healthy. It causes us to have a better staff, to spend more money to keep pace, and to go beyond simply reacting to news — to go out and anticipate what people will want to know about.

"We're in a tropical paradise here. We have sun, water, the Everglades, lots of nature — a nice environment. People coming here look forward to a lot; but human nature being what it is, there is a tendency to gripe and complain when expectations run higher than reality. This can create a lot of negative

thoughts. So in our news and in our editorials we try to give people confidence in the place they live in. 'Things aren't all bad...guess what happened today...here's what you can do at no cost this weekend...482 places to go and attractions to see...' In the course of handling the news we try to lessen human anxiety and give people a feeling of hope. We give them a kind of renewal of feeling good about themselves and their community.

"We've maintained our film capability, because not to do so would cut off some sources of news illustration. All our news photographers have CP-16 film cameras assigned to them. The handy thing about film is that the photographers can keep these cameras with them all the time, even take them home — they're so portable. Then if we need coverage in a hurry, we can call the photographers at home, and they don't have to spend a lot of time driving to the station to pick up their gear. They're always ready.

"We cover news from Key West to the Bahamas, so we depend on stringer correspondents in distant areas. They send their stories in on film.

"Our public affairs show, *Montage*, is shot on film for another reason — our news photographers and editors simply feel they can achieve things on film they can't do any other way — they get a 'look,' a 'feeling' they like.

"Administration consumes more of my time than news work; and that's a little unfortunate, because being a news director is a little like being a fire chief, you know. You'd rather be out there chasing fires than watching the firemen. I still like to keep my hand in, putting out the flames."

In our publication, TELEK, broadcasters talk about their experience, and we tell you about our latest technical and product developments. If you would like to be on our mailing list, write: Eastman Kodak Company, Dept. 640, Rochester, NY 14650.



EASTMAN KODAK COMPANY
ATLANTA: 404/351-6510
CHICAGO: 312/694-5300
DALLAS: 214/351-3221
HOLLYWOOD: 213/464-6131
NEW YORK: 212/262-7100
ROCHESTER: 716/254-1300
SAN FRANCISCO: 415/928-1300
WASH., D.C.: 202/554-9300

© Eastman Kodak Company, 1979



Kodak... Official motion picture consultant to the 1980 Olympic Winter Games.

Circle 179 on Reader Service Card

www.americanradiohistory.com



WHY ARE WE ADVERTISING A RADIO CARTRIDGE SYSTEM THAT ISN'T FOR SALE?

Two reasons.

First, when our CentraCart™ System is for sale, you're going to be in for a few surprises. The cartridge itself is unlike any you've ever seen before. And that's good, because we found out real quickly that many of the flaws in today's cartridge systems are due to the basic imperfection of today's cartridge design.

Our cartridge contains virtually no moving parts. And it allows the tape to pass across the center of the cartridge, instead of the front of the cartridge. As a result, tape tension is more constant, tape wear is minimized, and signal stability depends more on the capstan and less on the cartridge.

We improved the rest of the system, too. The record unit and the playback units. But the cartridge is where you'll really notice the difference. It's a clean break with tradition and, frankly, we want to give you plenty of time to get used to the idea.

Second, we're promising a whole new era in radio cartridge systems with the introduction of CentraCart™. Finally, after

fifteen years of sound engineered for the '60's, you'll be hearing sound engineered for the '80's—cartridge sound comparable with reel-to-reel sound. That's quite a promise. And we want to be sure, before we sell a single CentraCart™ System, that it's ready to live up to that promise.



3M

The Source '79

ITT JENNINGS

970 McLaughlin Ave San Jose CA 95122
408 292-4025

Coaxial switchers, variable vacuum capacitors; RF voltmeters; vacuum relays, coaxial relays & switchers; RF switchers VS

ITT SUPRENANT

172 Sterling St Clinton MA 01510
617 365-6331

Coaxial cables, instrumentation cable, high temperature wire, control cable

IVIE ELECTRONICS INC

500 W 1200 S, Orem UT 84057
801 224-1800

Audio amps (pre-amps, power, public address); active equalizers and filters; frequency monitors & counters; audio gens; voltmeters, dB meters; harmonic distortion meters VS

J

J&D ELECTRONICS DIV J&D INTERNATIONAL Unit E-East, Interstate Ind Pk Bellmawr NJ 08031 609 931-4100

Monitor, distribution amps; chroma keyers, processing amps, pulse & distribution amps, video production switchers, black burst generators, special effects generators, colorizer, equalizer; post production switchers; routing switchers; emergency power equip

JAMES B. LANSING SOUND INC (JBL) 8500 Lansing Blvd Northridge CA 91329 213 893-8411

Audio amps (line, pre-amps, monitor, power, public address); speakers; audio monitors; electronic crossover units; audio compressors VS

JAMIESON FILM COMPANY

6901 Forest Park Rd Dallas TX 75235
800 527-2298

Color film processors; film processor accessories

JAMPRO ANTENNA CO DIV OF CETEC CORP 6939 Power Inn Rd Sacramento CA 95828 916 383-1177

AM, FM, TV antennas; antenna accessories; RF filters; RF phasing networks, TV combiners, FM diplexers; antenna tuning units, DA equip VS

THE JANSON INDUSTRIES

Box 6090 Canton OH 44706
216 455-7029

Lighting equip heads, stands & fixtures, set design VS

JAVELIN ELECTRONICS

6357 Arizona Circle Los Angeles CA 90045
213 641-4490

Camera lenses & accessories; picture monitors; portable helical VTR

JBL—See James B Lansing Sound

JEFFERSON DATA SYSTEMS

Executive Plaza 501 Archdale Dr Charlotte NC 28210

704 374-3631

Business data systems for radio & TV

JOHANSON MFG CO

Rockaway Valley Rd Boonton NJ 07005
201 334-2676

Variable capacitors

JOHNSON ELECTRONICS INC

62 South Hwy 17-92 Casselberry FL 32707
305 339-2111

Audio dist, power, public address amps; pre-amps; SCA FM translators; receiving antennas

JVC INDUSTRIES—See US JVC Corp



K

K&H PRODUCTS LTD

PO Box 246 N Bennington VT 05257
802 442-9118

ENG camera mounting braces, dollies, ENG equip carts, shipping cases

KAHN COMMUNICATIONS INC

839 Stewart Ave Garden City NY 11530
516 222-2221

Passive equalizers and filters; telephone coupling equip; stereo RF equip

KAITRONICS CORP

1540 Gilbreth Rd Burlingame CA 94010
415 697-9102

SMPTÉ time code equip; tape evaluators; alphanumeric generators; tape loggers; machine control systems VS

KALART VICTOR CORP

Hultenius St Plainville CT 06062
203 747-1663

Large screen TV projectors; TV image enhancer; optical multiplexer; TV film chain; 16mm movie projectors, film editing equip, accessories; video attenuators; opaque, overhead & lantern slide projectors VS

KALLMAN ASSOCIATES INC

2525 Hyperion Ave Los Angeles CA 90027
213 660-4900

Character/graphics and alphanumeric generator systems, monitor calibrators

KAMAN SCIENCES CORP

1500 Garden of the Gods Rd PO Box 7463
Colorado Springs CO 80933
303 599-1500

Radio and TV computer business services VS

KANDTT PRODUCTS

Box 246 N Bennington VT 05257
802 442-9118

ENG camera braces & dollies; carry and shipping cases

KAPPA NETWORKS INC

165 Roosevelt Ave Carteret NJ 07008
201 541-1600

Audio & video delay lines; video filters

KAY ELEMETRICS CORP

12 Maple Ave Pine Brook NJ 07058
201 227-2000

Audio spectrum analyzers; rotary attenuators, slide attenuators; RF generators

KAY INDUSTRIES INC

604 N Hill St South Bend IN 46617
219 234-0171

Rotary phase converters (single phase to three phase)

KEYLINE INC

3260 Scott Blvd Santa Clara CA 95051
408 246-6830

Videotape

KINGS ELECTRONICS

40 Marbledale Rd Tuckahoe NY 10707
914 793-5000

Video patch panels; RF connectors VS

KITCHEN PRODUCTIONS

205 Silver Ridge Dr Ridgecrest CA 93555
714 375-2753

FM & TV translators

KLIEGL BROS INC

32-32 48th Ave Long Island City NY 11101
212 786-7474

Lighting hardware, heads, stands and fixtures; automated and manual controls; patch terminals, plugs & connectors; lighting kits VS

KLINE IRON & STEEL CO

PO Box 1013 Columbia SC 29202
803 779-7080

Towers, tower hardware & construction equip

VS MEANS IT'S VERIFIED

KNOX VIDEO PRODUCTS

9700-B George Palmer Hwy Lantham MD 20801
301 459-2106

Graphic art character generators VS

See ad pg 35—refer to rep/dist section

KODAK—See Eastman Kodak Co

KOLLMORGEN CORP PHOTO RESEARCH DIV
3000 N Hollywood Way Burbank CA 91505
213 843-6100

Exposure meters; color temperature meters; spot brightness meters

KORTICK MFG CO

5600 Third St San Francisco CA 94124
415 822-6660

Pole line hardware

KOSS CORP

4129 N Washington St Milwaukee WI 53212
414 964-5000

Headphones, dynamic & electrostatic; speakers

KREONITE INC

715 E 10th St PO Box 2099 Wichita KA 67201
316 263-1111

Film lab and graphics studio design; film processors; studio cabinets and furniture; lighting stands and fixtures VS

L

LAIRD TELEMEDIA INC

2125 SW Temple Salt Lake City UT 84115
801 487-6251

Character generators; telecine multiplex equip;

slide projectors; automatic telecine light control VS

See ad pg 192—refer to rep/dist section

LAMPKIN LABS INC

PO Box 9048 Bradenton FL 33506
813 792-5566

FM deviation meters; communication service monitors for mobile radio

LANDY ASSOCIATES INC

1890 E Marlton Pike Cherry Hill NJ 08003
609 424-4660

Rental service; distributor of full line of audio and video production equipment; equipment racks

The Source '79

LAUDERDALE ELECTRONIC LABS 16 SW 13 St Ft Lauderdale FL 33315 305 764-7755

Audio distribution amps & pre-amps; ALC & AGC amps; AM & FM compressor/limiter/filters; passive & active equalizers & filters; reverb units; turntable pre-amps & controls; studio cabinets & furniture; tape cartridges, cassettes & test tapes; leader tape; tape timers; head degaussers; bulk erasers; cartridge & cassette storage; telephone coupling equipment; audio connectors & accessories; splitter/combiners; record maintenance; digital clocks; timers; radio studio design

LEADER INSTRUMENT CORP 151 Dupont St Plainview NY 11803 516 822-9300

Frequency monitors & counters; audio generators; multiple output video generators; impedance bridges; multimeters; voltmeters; harmonic distortion meters; oscilloscopes; video test generators; wow & flutter meters; sync gen. systems (color bar, black burst, staircase/ramp, multiburst)

LEAR SIEGLER INC BOGEN DIV Box 500 Paramus NJ 07652 201 343-5700

Amplifier failure detectors, extenders, transformers, intercom system; audio amps (distribution, line, pre-amps, monitor, power, public address); power supplies, ALC & AGC amps, compressor/limiters, AM & FM; equalizers & filters (passive & active)

LEASAMETRIC 1164 Triton Drive Foster City CA 94404 415 574-4441

Telecommunications test equip. rentals VS

LEBOW LABS INC 424 Cambridge Allston MA 02134 617 782-0600

Radio and TV studio design and installation; distributor of full line of audio & video equipment, lighting equip; timing/logging equip

LEE-RAY INDUSTRIES INC 38 E 1 Ave Mesa AZ 85202 602 962-6806

Video equipment carriers VS

LECTROTECH INC 5810 N Western Ave Chicago IL 60659 312 769-6262

Color picture monitors; oscilloscopes, vectorscopes, waveform monitors & analyzers VS

LEGAL TAPES INC 22530 West Eight Mile Road Southfield MI 48034 313 353-3355

Post production service; video tape/film recording transfer VS

LEITCH VIDEO LTD UNIT 46705 Progress Ave Scarborough Ontario M1H 2X1

416 438-5060
Video amps (processing, pulse & distribution, subcarrier, clamping); sync gen. systems; delay lines; equalizers; digital, master & slave clocks; time distribution systems; multiple output video test generators VS

LENCO INC ELECTRONICS DIV 300 N Maryland St Jackson MO 63755 314 243-3147

Color encoders, processing amps; pulse distribution amps; sync generators; black burst generators; video presence detector; video noise meters, test generators; b&w & color picture monitors; delay amps; routing switchers; signal equalizing systems; video delay lines; comb encoders; video equalizers; oscilloscopes; VITS, VIR systems & equip; waveform monitors & analyzers; diff phase-gain measurement

See ad pg 81—refer to rep/dist section
GA Lenco Box 4042 Albany 31706..... 912 436-4927
KS Lenco 1120 S 4th St Atchison 66002..... 913 367-1146
MD Lenco 7303 Poplar Ln Middletown 21769..... 301 371-5588
TX Lenco 13620 Littlecrest Dr Dallas 75234

LEVIT ELECTRONICS 200 Park Ave S New York NY 10003 212 777-5517

RF tubes, vacuum tubes, camera pickup tubes; rectifiers VS

LENZAR OPTICS CORP 210 Brant Rd Lake Pk FL 33403 305 844-0263

Camera lenses

LEXICON INC 60 Turner St Waltham MA 02154 617 891-6790

Audio digital delay system; variable speed tape recorder; speech compressor/expander

LIGHTNING ELIMINATION ASSOC 12516 Lakeland Rd Santa Fe Springs CA 90670 213 944-0916

Dissipation array system; transient and surge eliminators; lightning warning systems VS

LINES AUDIO/VIDEO SYSTEMS Jefferson at McDaniel Springfield MO 65806 417 862-5533

Small video switcher/fader

LIPSNER-SMITH CORP 4700 Chase Lincolnwood IL 60646 312 675-8473

Ultrasonic film cleaning machines VS

VS MEANS IT'S VERIFIED

LISTEC TELEVISION EQUIPMENT CORP

39 Cain Dr Plainview NY 11803
516 694-8963

Video & cine camera heads, pedestals, tripods, cranes, dollies (Vinten and TVP) audio consoles, portable; video delay line (BAL); prompting systems (Autocue); character/graphics systems VS

See ad pg 139
CA Listec 4527 San Fernando Rd Glendale 91204..... 213 244-0838

LOGITEK ELECTRONIC SYSTEMS 3320 Bering Dr Houston TX 77057 713 782-4592

EBS two tone systems; audio amps (pre-amps, monitor, power); audio consoles (mono, stereo, TV); turntable pre-amps and controls; timers; game show equip (custom) VS

See ad pg 188—refer to rep/dist section

LONG ENGINEERING CO 961 Burke St Winston Salem NC 27101 919 729-2306

Multi-media; radio & TV studio design, facility turnkey installation; custom mixers and consoles (Deltronix); amp modules, transformers (Deltronix); intercom systems (Deltronix)

LOWEL-LIGHT MANUFACTURING INC 421 W 54th St New York NY 10019 212 245-6744

Lighting heads, stands & fixtures; portable lighting kits; diffusion material; gels & filters VS

See ad pg 207
CA Lowel-Light 3407 W Olive Ave Burbank 91505..... 213 846-7740

LPB INC 28 Bacton Hill Rd Frazer PA 19355 215 644-1123

Audio dist. amps; AM & FM compressor/limiters; audio consoles (mono, TV); turntables, pick-up arms, pre-amps & controls; studio cabinets and furniture; AM & FM transmitters, exciters; RF carrier current VS

See ad pg 167—refer to rep/dist section
CA Richard W. Burden 20944 Sherman Way Suite 216 Canoga Park 91303..... 213 340-4590

L-W INTERNATIONAL 6416 Varle Ave Woodland Hills CA 91367 213 348-8614

Athena telecine; flickerless projectors; 16mm film chain projectors; slomo/freezeframe telecine projectors VS

See ad pg 195

LUMITROL LTD 400 Don Park Rd Unit 23 Markham L3R IC6 Ont 416 495-1762

TV studio design; hanging cord patch panels; digital junction box; rigging, drapery, curtains, grids, battens, screens & frames VS

M

3M CO MAGNETIC AUDIO/VIDEO PRODUCTS DIV

3M Center Bldg 223-5N St Paul MN 55101
612 733-1662

Full line of audio & video recording tape; magnetic film; accessories VS

See ad pg 37

3M CO MINCOM DIV 3M Center Bldg 23-5E St Paul MN 55101 612 733-7603

Video character generators, titling and graphics systems, random access disc memory; video production switchers, VI bridging switcher; sync generators; distribution amps; processing amps; helical drop out compensator; video encoder; video routing systems; audio routing systems; special effects equipment; image enhancers; pulse & subcarrier amps; colorizers; comb decoders; chromakeyer; studio & logging open-reel recorder/players VS

continued on page 130

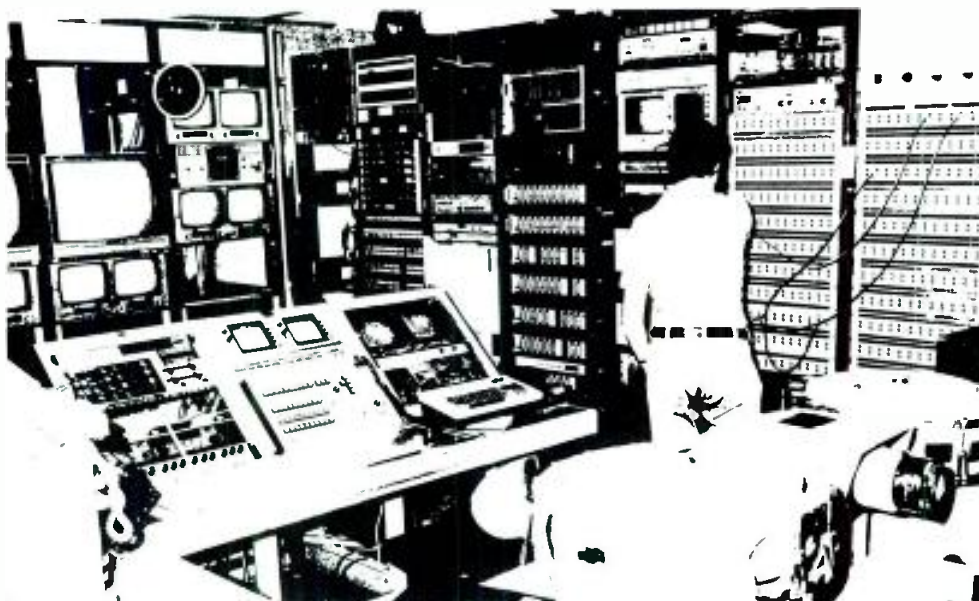

For quality performance,
outstanding service,
and ease of ownership...

Freelance cameramen choose MNC-71CP!

For enterprising freelance TV-news/documentary cameramen who prefer the advantages of owning their equipment, going ENG involves a crucial hardware decision. With little margin for error.

The ideal choice, of course, is our reliable and versatile MNC-71CP. Delivering outstanding broadcast-quality performance at a very reasonable price. And with Cinema Products' reputation for responsive after-sales backup and meticulous service, freelancers couldn't do better!

We offer complete camera/lens and accessories package deals — including Steadicam — to meet your every requirement. And our exciting "state-of-the-art" lease/upgrade program is tailor-

made to ease the financial strain, allowing you all the benefits and tax write-offs of equipment ownership, with payments substantially lower than the prevailing monthly rental rates. With built-in



Special Steadicam/MNC-71CP Offer

For a limited time only, we are offering a special package deal consisting of our Oscar-winning Steadicam videofilm camera stabilizing system and MNC-71CP ENG/EFP video camera plus co-ax control. For further information and prices, contact Don Dunbar, Director of National Marketing.

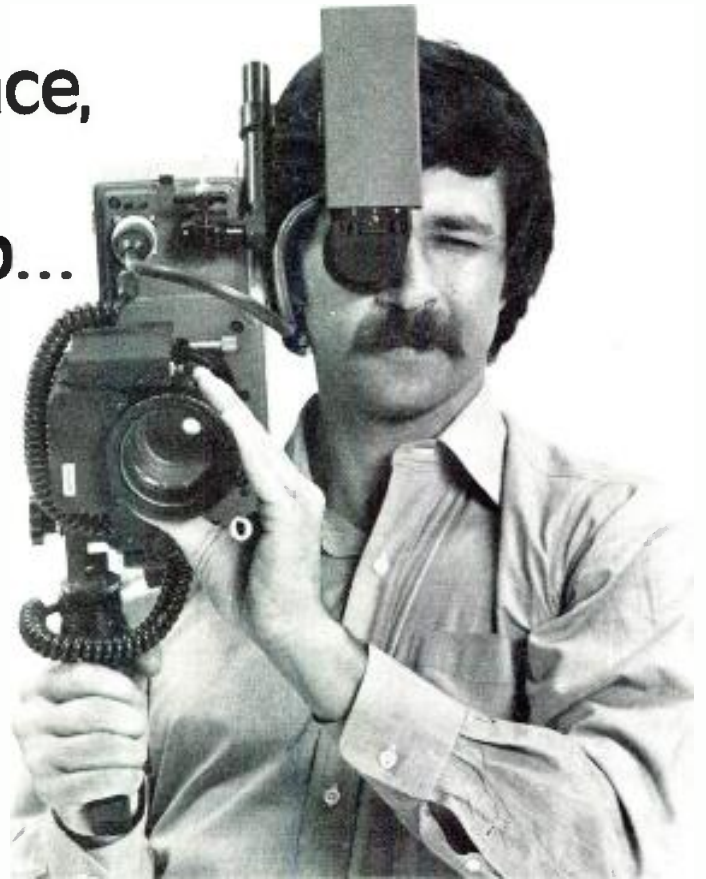

protection against obsolescence to boot!

All this plus the entire Cinema Products video service department at your beck and call...24 hours a day, seven days a week.

Plus a full one-year warranty, with no service charge ever for warranty work.

Plus a national network of MNC-71CP dealers with "stand by" loaner/rental cameras, so you need never worry about missing out on an assignment!

With 1980 already shaping up as a hectic TV-news year — what with the presidential primaries and national elections generating extra coverage all over the country —

make sure you are ready with all the video equipment you need to secure your share of freelance TV-news/documentary assignments.

Buy or lease your MNC-71CP now, and start reaping the benefits of ownership immediately!



For full details, call toll-free: 800-421-7486.

cinema  products
CORPORATION

Technology in the Service of Creativity

2037 Granville Avenue, Los Angeles, California 90025
Telephone: (213) 478-0711 • (213) 477-1971 • Telex: 69-1339

The Source '79

MACH ONE — See TeleMatlon

MACKENZIE LABS INC
5507 Peck Road Arcadia CA 91006
213 579-0440

Single, dual, multiple tape, continuous loop cartridge player/recorders; film projectors (motion picture); automatic light dimmer control

MAGNASYNC/MOVIOLA CORP
5539 Riverton Ave N Hollywood CA 91601
213 763-8441

Film editing equip; field & studio magnetic film recorders & accessories **VS**

MAGNA-TECH ELECTRONIC CO INC
630 Ninth AVE New York NY 10036
212 586-7240

Audio mixing consoles; open-reel player/recorder, studio systems; tape head replacement; film projectors (motion picture & flickerless); magnetic recording equip & accessories; multi-lock video & magnetic film; video-motion picture interlock equip; telecine equip. **VS**

See ad pg 177

MAGNECRAFT ELECTRIC CO
5575 N Lynch Chicago IL 60630
313 282-5500

Coaxial and RF switches/relays

MAGNETIC REFERENCE LAB
229 Polaris Ave Suite 4 Mountain View CA 94043

415 965-8187 **VS**
Test tapes

MARATHON PRODUCTS
334 W Boylston St W Boylston MA 01583
617 853-0988

Tape cartridges; empty reels, carts & cassettes; tape cleaners; torque & speed indicators; head degaussers; splicing block; auto loaders **VS**

MARCONI ELECTRONICS INC
100 Stonehurst Court Northvale NJ 07647
201 767-7250

Studio, studio/field convertible & ENG/EFP cameras; Type C One-inch helical VTRs; VTR editor/controller, slow motion controller; production switchers; TV transmitters; video pulse & dist amps; audio mixing consoles; intercom systems **VS**

See ad pg 93—refer to reps/dist section

MARCONI INSTRUMENTS DIV
100 Stonehurst Ct Northvale NJ 07647
201 767-7250

Modulation monitors; TV sideband analyzers, spectrum analyzers, video test generators; automatic TV monitors, digital synchronizers, noise test sets; sweep generators; other TV test gear; frequency counters; audio & RF signal generators; distortion meters; timing interval measurement; VITS analyzer **VS**

See ad pg 63—refer to repdist section

MARTI ELECTRONICS INC
PO Box 661 Cleburne TX 76031
817 645-9163

Remote pick-up & aural STL equip; audio amps (line, monitor, power); remote control telemetry; RF amps; SCA equip; audio compressor/limiters (AM&FM); mics (dynamic & wireless); ALC & AGC amps; microwave equip (intercity, portable, ENG); RF program subcarriers; RF switchers **VS**

MATSUSHITA — See Panasonic

MATTHEY PRINTED PRODUCTS LTD—See Television Equipment Associates

MAXELL CORPORATION OF AMERICA
60 Oxford Dr Moonachie NJ 07074
201 440-8020

Audio tepe, helical video tape

McCURDY RADIO INDUSTRIES
1711 Carmen Dr Elk Grove Village IL 60007
312 640-7077

Audio consoles; audio amps (dist., pre-amps,

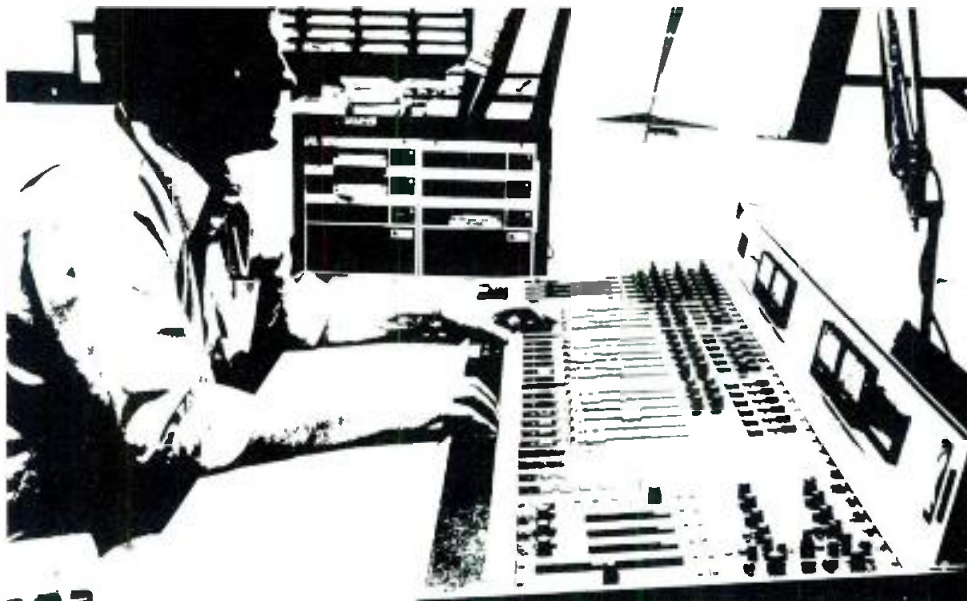

monitor, power); active equalizers; filters; intercom systems; patch panels; turntable pre-amps & controls; digital clocks and timers; monitor speakers; racks; cabinets, console assemblies; complete studio installations **VS**

See ads cover 2, pg 88

NJ McCurdy 223 W Saddle River Rd Saddle River 07458 201 327-0750
CAN McCurdy 108 Carnforth Rd Toronto ONT MUA 2L4 Canada 416 751-6262

MCG ELECTRONICS INC
160 Brook Ave Deer Park NY 11729
516 586-5125
Surge protectors

McGRAW-EDISON DIV EDISON ELECTRONICS
Grenier Ind Air Park Manchester NH 03103
603 669-0940
RF attenuators

MCI INC
4007 NE 6th Ave Fort Lauderdale FL 33334
305 566-2853

Fullline audio consoles, open reel recorder/players; phasemeters; VU and peak meters; magnetic film recording accessories; stereo phase enhancer; SMPTE time code synchronizing systems; DC meters **VS**

McKAY DYMEK
PO Box 5000 Claremont CA 91711
714 621-6711

High fidelity AM receiver; shielded loop antenna; audio monitors; all-wave receiving antenna; communication receivers; RF preselectors **VS**

See ad pg 117. Call main office for nearest dealer.

McMARTIN INDUSTRIES INC
4500 S 76th Omaha NE 68127
402 331-2000

AM & FM transmitters; exciters; remote control equip; remote pickup; SCA equip; FM antennas; antenna monitors; audio & TV consoles; audio mixers; line amps; audio limiters; PA amps; RF amps; frequency monitors and counters; modulation monitors; RF program subcarrier, carrier current; demodulators, exciters, modulators **VS**

See ad pg 200

AK	T. Butler PO Box 119 Limestone 72646	501 428-5257
AL	R Hanseth 4044 Knoll Top Ct Carmichael 95608	916 485-2605
CA	R Switzer 22262 Chestnut Ln El Toro 92630	714 837-5250
FL	R Beattie 3317 Barrow Hill Trail Tallahassee 32308	904 893-1382
IL	J Tollefson 914 S Lynn Champaign 61820	217 356-5436
IN	R Sawicki 2944 Carnaby St Indianapolis 46229	317 897-1933
LA	R Coppola 15316 Russett Rt 1 Prde 70770	504 261-7507
MN	B Emery 4691 142 St W Apple Valley 55124	612 423-1489
NY	R Marshall 10 Kreag Rd Fairport 14450	716 223-5270
TX	D Jones 2608 Mollimar Plano 75074	214 596-5503
WA	J Schneider 13516 89 Pl NE Kirkland 98033	206 823-1500

MEDIA CONCEPTS INC
559 49 St S, St Petersburg FL 33707
813 821-2122

Automated VHS VTR systems; time code gens/readers; production equip rentals; post production services; videotape/film recording transfer **VS**

MEMOREX CORP
1200 Memorex Dr Santa Clara CA 95052
408 987-1072

Audiotape; audiotape accessories; videotape for all video record formats; videotape accessories **VS**

MERLIN ENGINEERING WORKS
1880 Embarcadero Palo Alto CA 94303
415 856-0900

Rebuilt VTR machines; high band color systems; air systems; TBCs; custom built quad VTRs & accessories

MICHIGAN MAGNETICS
203 W 3 ST Vermontville MI 49096
517 726-0590

Replacement tape heads

MICMIX AUDIO PRODUCTS INC
2995 Ladybird Ln Dallas TX 75220
214 352-3811

Reverberation units; audio special effects units; LED PPM, VU meters **VS**

MICRO COMMUNICATIONS INC
PO Box 4365 Grenier Field Manchester NH 03108

603 624-4351
RF diplexers, attenuators, filters, loads, switchers; TV combiners, RF cables & connectors; antennas (FM, HP & CPTV); transmission line & connectors; RF wattmeters **VS**

MICRO CONSULTANTS INC (MCI/QUANTEL)
PO Box 50810 Palo Alto CA 94303
415 856-6226

Standards converters; framerstore & field synchronizers; time base correctors; repositioners, compressors, A/D converters, digital effects systems; image enhancers; digital noise reducers/filters; animation **VS**

See ad pg 152

CA	Charles Martin 18931 Sylvan St Reseda 91334	213 345-9880
CT	D Dever, 300 Broad St Stamford 06901	203 348-4104
GA	Paul Fletcher 2971 Flowers Rd S Atlanta 30341	404 457-1266
KS	R Frillman 6617 Hallett Shawnee Mission 66201	913 631-8293

MICRO CONTROL ASSOCIATES
PO Box 13250 Arlington TX 76013
817 265-2911

STL, remote control and SCA subcarrier equip **VS**

MICROFLECT CO INC
3575 25th St SE Salem OR 97302
503 363-9267

Towers, tower hardware & construction equip, tower lighting

continued on page 132

Now! For heterodyne VTRs



a broadcast quality, digital TBC

It's the CVS 516, first digital TBC made and priced to give users of non-segmented, heterodyne VTRs all the proven advantages of modern digital video processing.

The CVS 516 is ideal for ENG, teleproduction, studio VTR backup and much more because it has features that, before, you'd find only in TBCs costing up to twice as much.

Correction of chroma/luminance delay problems, a chroma noise reduction of 3 dB, velocity compensation and color dropout compensation are all standard. So are a broadcast stable, gen-lock sync generator and a built-in, completely adjustable processing amplifier.

The 516 also includes circuitry to closely control FCC blanking problems. For example, it combines exclusive CVS Gyrocomp memory organization with a 2 line (or optional 16 line) memory, automatic VTR advanced sync and available H and V blanking adjustments. The result is complete control of output blanking.

Simple operation is another plus. Front panel con-

trols give you total mastery of your video signal. Each control also has a preset unity position to give you a consistent starting point for all your tapes.

If all that's not enough, add our optional, moderately priced Image Enhancer/Noise Reducer. This plug-in card substantially reduces luminance and chroma noise, and significantly improves subjective resolution.

The CVS 516 weighs only 35 pounds, stands just 3½ inches high and uses only 175 watts—major advantages with today's increased emphasis on ENG and field production.

So, to give your heterodyne productions the quality they deserve, get the one digital TBC made and priced to do the job—the CVS 516.

For full details and/or a demonstration, contact your Authorized CVS Distributor, or CVS, today. Also, be sure to ask for our popular booklet about the basics of digital time base correction, and a reprint of the article "TBCs, Blanking and the FCC."



Consolidated Video Systems, inc.

U.S. Headquarters
1255 E. Arques Avenue
Sunnyvale, California 94086
Phone: (408) 737-2100
Telex: 35-2028

European Office
293 Regent Street
London, W1V2HR England
Phone: 636 3850
Telex: 268316

Far East Office
P.O. Box 150, Crows Nest
N.S.W. 2065, Australia
Tel: 439-1651/439-3013

Circle 180 on Reader Service Card

www.americanradiohistory.com

The Source '79

MICROPROBE ELECTRONICS INC
Suite 1532A 875 N Michigan Ave Chicago IL
60611
312 440-3111

Automatic sequencers, complete automation systems VS

MICPOTIME INC
1280 Blue Hills Ave Bloomfield CT 06002
203 242-0761

Time base correctors; image enhancers, color correctors; dropout compensators; video delay lines & filters; frame synchronizers; digital master control & auto VTR systems; time code gens/readers VS

See ad pg 66—refer to rep/dist section

MICRO-TRAK CORP
620 Race St Holyoke MA 01040
413 536-3551

Audio dist amps, pre-amps; mono, stereo, audio for TV, portable & sportcaster consoles; studio cabinets & furniture; audio cart storage; antenna heater controls; racks, cabinets & shipping cases; turntables, pickup arms; turntable pre-amps & controls; complete disc consoles VS

See ad pg 203

MICROTRAN CO INC
145 E Mineola Ave Valley Stream NY 11582
516 561-6050

Mic accessories; tape and head erasers (degaussers, bulk erasers); telephone coupling equip.; spot tape editing erasers; transformers

MICROVISION SYSTEMS
PO Box 1676 San Mateo CA 94401
415 348-1344

Video:tape editor controller

MICROWAVE ASSOC INC
63 Third Ave Bldg 5 Burlington MA 01803
617 272-3100
Digital audio modulators & demodulators; mic-

rowave STLs; intercity, portable & ENG microwave equip; RF amps, attenuators, converters, filters, loads, switchers; receive only satellite earth stations; program subcarriers; microwave antennas VS

MICROWAVE ASSOCIATES INC (LAND MOBILE COMMUNICATIONS DIV)
850 A Stewart Dr Sunnyvale CA 94086
408 736-9330

UHF/VHF transmitter combiners, receiver combiners, isolators, circulators; RF filters, loads, terminations. power meter panels

MICROWAVE POWER DEVICES INC
Adams Court Plainview NY 11803
516 433-1400

Microwave power amps; RF amps; FM, TV transmitters

MID-STATE COMMUNICATIONS INC
174 S First Ave Beech Grove IN 46107
317 787-9426

FM & TV field intensity meters; frequency monitors & counters; spectrum analyzers VS

MILLER-STEPHENSON CHEMICAL CO INC
Geo. Washington Hwy. Danbury CT 06810
203 743-4447

Degreaser, head cleaner; contact cleaner

MINNEAPOLIS MAGNETICS INC
3104 W Lake St Minneapolis MN 55416
612 927-8841

Magnetic tape recorder heads; replacements for leading recorder brands; rebuild head assemblies VS

MODULAR AUDIO PRODUCTS UNIT OF MODULAR DEVICES INC
50 Orville Dr Bohemia NY 11716
516 567-9620

Audio dist, line, monitor & power amps; pre-amps; op-amp modules; amplifier power supplies; active equalizers & filters; mono, stereo, quad & audio for TV consoles; AM compressor/limiters VS

See ad pg 187—refer to rep/dist section



MODTEC—See Broadcast Electronics

MOHAWK WIRE & CABLE CORP
9 Mohawk Dr Leominster MA 01453
617 537-9961
Wire and cable

MOLE-RICHARDSON CO
937 N Sycamore Ave Hollywood CA 90038
213 851-0111

Lighting heads, stands, stands & fixtures; diffusion material; gels & filters; dimmer packs; plugs & connectors VS

MONROE ELECTRONICS INC
100 House! Ave Lyndonville NY 14098
716 765-2254

Unattended phone answering devices, tone signal generators, detectors, timers, comm & monitor receivers; remote control & monitoring systems VS

MOOG MUSIC INC
2500 Walden Ave Buffalo NY 14225
716 681-7200
Music synthesizers

MOSELEY ASSOCIATES INC
111 Castilian Dr Santa Barbara CA 93017
805 968-9621

ALC and AGC amps, microwave systems for remote pickup & STLs; RF amplifiers; status & alarm indicators, FM processors; AM & FM compressor/limiters/filters; intercity, portable & ENG microwave equip; RF program subcarriers; portable audio consoles; transmission line & connectors; antenna monitors; log printers; remote control systems VS

See ad pg 191

MOTOROLA
2130 Palmer Dr Schaumburg IL 60196
312 576-3591

AM stereo exciter, AM stereo monitoring equip VS

VS MEANS IT'S VERIFIED

MPB TECHNOLOGIES INC
PO Box 160 Ste Anne de Bellevue Que H9X 3L7
514 457-2035

Character/graphics systems; color encoders; software; character and logo font creation

MPCS VIDEO IND INC
514 W 57 St New York NY 10019
212 586-3690

Production equip rental; post production services; TV studio design; video tape/film recording transfer; video camera & monitor modification; distributor of full line of video equip

MSI TELEVISION DIV OF COM TEL INC
4788 S State St Salt Lake City UT 84107
801 262-8475

Alphanumeric generators

MU-DEL ELECTRONICS INC
2426 Linden Ln Silver Spring MD 20910
301 587-6087

RF amps; RF attenuators & multicouplers; band-pass filters; diplexers; RF converters VS

continued on page 134

1127 PRODUCTION SWITCHER

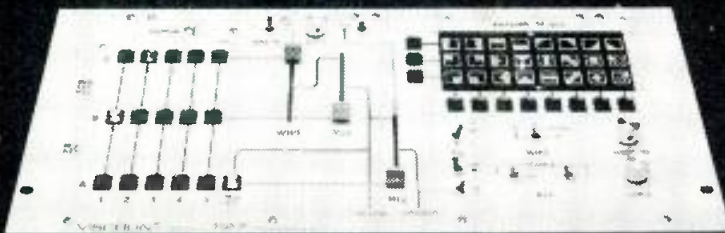

• \$3765

- COLOUR • DOWNSTREAM KEY
- ROTATIONAL PATTERNS
- MICROPROCESSOR BASED

ISCOUNT INDUSTRIES Ltd

105 EAST 69th AVE., VANCOUVER, B.C.,
CANADA V5X 2W9 - PHONE (604) 327-9446 TELEX 04-508605

CALL OR WRITE FOR FULL DETAILS

Circle 181 on Reader Service Card

You already own the most important part of a Convergence tape editing system.



You!

In video tape editing, there's no substitute for your talent. And there's no better way to complement it than with a Convergence Superstick Editing System.

Add your skills to our system, and watch your ideas take shape on tape easily and accurately. Try our ECS-103 for example, a versatile approach to both single and multi-source editing. Use it for everything from simple cuts to stunning special

effects. Put it to work with different formats. Edit on-line or off-line with $\frac{3}{4}$ " cassettes and 1" Type C reels. Experience a new dimension in efficiency. And get your concepts implemented on time and within budget.

The ECS-103 tops our line of people-pleasing, computer based editors. Just add your talent, and you've got a complete system. For details, use the reader service card or contact:

Convergence Corporation, 1641 McGaw
Irvine, CA 92714; phone (714) 549-3146

Editing means Convergence



CONVERGENCE
CORPORATION

Circle 182 on Reader Service Card

www.americanradiohistory.com

The Source '79

MULTIPLIER INDUSTRIES CORP

464 S 10th Ave Mt Vernon NY 10550
914 699-0990

Surge protectors; batteries; instrument protection cases

MULTI-TRACK MAGNETICS INC

508 Livingston St Norwood NJ 07648
201 768-5037

Telecine chains, high speed dubbers, interlock systems for multi-media presentations

MULTRONICS INC

730 W McNab Rd Ft. Lauderdale FL 33309
305 974-0300

RF phasing network, RF inductors; diplexers; antenna tuning units; DA equip; RF filters, AM antennas; transmission line & connectors

MXR INNOVATIONS INC PROFESSIONAL PRODUCTS GROUP

247 N Goodman St Rochester NY 14607
716 412-5320

Digital audio delay system; pitch shifting device and flanging/doubling device for special effects; graphic equalizers

N

NAGRA MAGNETIC RECORDERS INC

19 W 44th St New York NY 10036
212 840-0999

Miniature open-reel audio/cine recorders; hand-held mixers; lavalier mics, tape reels, tape timers; portable open reel tape player/recorders

NAGY RESEARCH PRODUCTS

PO Box 289 Mclean VA 22101
703 356-3963

Tape splicers

NAKAMICHI RESEARCH (USA) INC

1101 Colorado Av Santa Monica CA 90401
213 451-5901

Headphones; mics (dynamic, condenser, shotgun), mic accessories; noise reduction systems; audio cassettes; audio cassette recorder/players

NATIONAL ELECTROLAB LTD

1536 Columbia St No Vancouver BC V7J 1A4
604 985-0511

Audio monitor, RF receivers, comm & monitor, RF amps

NATIONWIDE ELECTRONIC SYSTEMS INC

1536 Brandy Parkway Streamwood IL 60103
312 289-8820

Automation equip, sequencers, controllers, memory units, auto loggers, complete systems; telephone coupling equip; VU meters; STL & remote pickups, SCA equip; time systems, frequency monitors and counters, voltmeters, multimeters, phase meters, status and alarm indicators

VS MEANS IT'S VERIFIED

NEC AMERICA INC BROADCAST EQUIP DIV

130 Martin Lane Elk Grove Village IL 60007
312 640-3792

Studio/field & ENG/EFP cameras, power supplies; digital noise reducers/filters; color correctors; pulse & subcarrier amps; automated master control systems; routing switchers; frame synchronizers; TBCs; helical one-inch VTRs and automated systems; electronic still stores; digital video effects, repositioners & compressors; diplexers; exciters; modulators; microwave STLs; intercity, portable & ENG microwave systems; remote pickup equip.; receive-only satellite earth stations; AM & FM, UHF & VHF TV transmitters; FM & TV translators; RF tubes

See ad pgs 86-87—refer to rep/dist section

CA Hugh Gillogly 17206 Pinot Pl Poway
92064.....714 485-9501

NEUMADE PRODUCTS CORP

720 White Plains Rd Scarsdale NY 10583
914 725-4900

Storage & filing cabinets for tape reels, cassettes, carts, rewriter; film cases, cleaners & editing equip; film inspection equip; racks, cabinets & shipping cases

RUPERT NEVE INC

Berkshire Ind Park Bethel CT 06801
203 744-6230

Full line audio consoles; audio amps (distribution, line, pre-amps); slide attenuators, switchers; active and passive equalizers and filters, special effects

See ad pg 13

CA Rupert Neve 6255 Sunset Blvd Ste 609
Hollywood.....213 465-4822
CAN Rupert Neve 2721 Rena Rd Malton
ONT L4T 3K1.....416 677-6611

NIKKO AUDIO

16270 Raymer St Van Nuys CA 91406
213 988-0105

Audio pre-amps & power amps; passive equalizers & filters; mono, stereo & quad consoles; turntables

NORTH AMERICAN PHILIPS CORP—See AKG

Div & Philips Audio Video Systems

NORTH AMERICAN TURBINE CORP

PO Box 40510 11500 Charles St Houston TX
77040

713 466-6200

Emergency generator systems

NORTHEAST BROADCAST LAB INC

Box 1176 15 Charles St S Glens Falls NY 12801
518 793-2181

Radio facility turnkey installations

NORTH HILLS ELECTRONICS INC

Alexander Pl Glen Cove NY 11542
516 671-5700

Hum bucking coils, RF inductors, transformers

**FIDELIPAC
CARTRIDGES
GIVE YOU
A PROPER
FIT.**

Somebody else's
will just
give you
fits.

It's simple. A broadcast cartridge should seat properly in a broadcast cartridge machine. But too many don't.

Fidelipac cartridges do. Fidelipac Model 300, 350 and Master Cart cartridges all conform precisely to NAB AA standards for both overall width and thickness.

So you get proper alignment with the tape heads in your machines. And proper sound from your machines. With less wow and flutter. Less mechanical noise. And fewer carts that go bump in the night. Or on the air.

So the choice is obvious. Get a proper fit with Fidelipac cartridges. Or have a proper fit with somebody else's.

See us at NRBA Booth #11

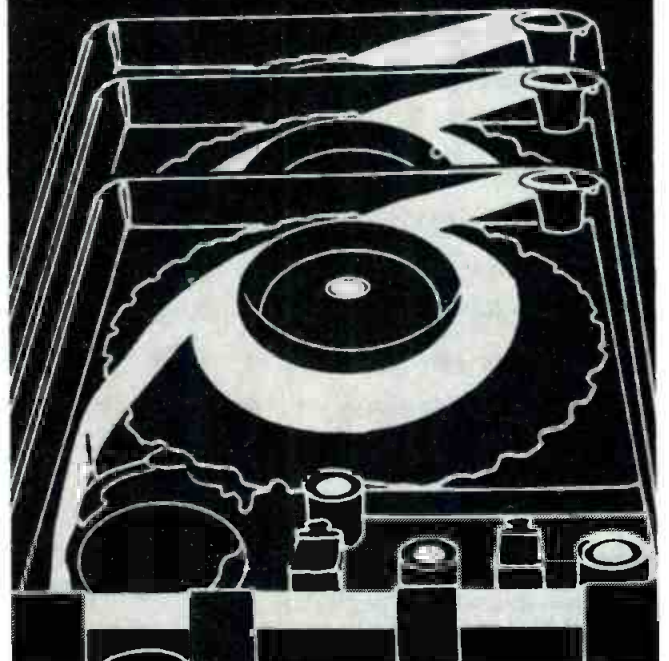

FIDELIPAC®

109 Gaither Drive • Mt. Laurel, NJ 08057
(609) 235-3511 U.S.A.

® Trademark

Who knows more about tape cartridges than Fidelipac?

Circle 183 on Reader Service Card

NORTH WIND POWER CO INC
PO Box 315 Brook Rd Warren VT 05674
802 796-2955

Battery chargers: wind-driven generating systems;
solar generators: thermal generators

NORTON CO AIR SPACE DEVICES
PO Box 7500 Cerritos CA 90701
213 926-0545

Tower accessories: safety devices: climbers

NORTRONICS CO INC RECORDER CARE DIV
8101 Tenth Ave N Minneapolis MN 55427
612 545-0401

Magnetic tape recorder heads; tape erasers; tape
editors; test tapes; recorder care accessories for
audio & video machines; VTR head cleaners VS

NOVA CORP
5801 Uplander Way Culver City CA 90230
213 888-5122

Videotape cleaner attachment for VTR; audio
de-poping for VR-1200/2000; speaker intercoms VS
See ad pg 204

NTI AMERICA INC
1680 N Vine St Suite 202 Los Angeles CA 90028
213 462-8945

Digital signal generators for color & mono video;
color time coder VS
See ad pg 207

FRED A NUDD CORP
1743 Route 104 Owtario NY 14519
315 524-2531

Towers: tower hardware & construction equip;
tower maintenance & inspections: pole hardware VS

NURAD INC
2165 Druid Park Dr Baltimore MD 21211
301 462-1700

Quad polarized antennas for remote TV
broadcasting; helical and parabolic ENG transmit
antennas; airborne microwave links; complete
microwave TV system design and turnkey
installations VS

O

OAK INDUSTRIES INC SWITCHER DIV
Crystal Lake IL 60014
815 459-5000

Rotary and push button switchers

OAK INDUSTRIES INC CATV DIV
Crystal Lake IL 60014
815 459-5000

Converters; convertor/decoders; scramblers for
CATV & pay cable TV; MDS decoders;
decoder/convertors for over-air subscription TV VS

O'CONNOR ENGINEERING LABS INC
100 Kalmus Dr Costa Mesa CA 92626
714 979-3993

Camera tripods and heads VS

OKTEL CORP
490 Division St Campbell CA 95008
408 374-1811

Slo mo, variable speed & time lapse video action
recorders; electronic still stores

OLESEN
1535 Ivar Ave Hollywood Ca 90028
213 461-4631

Lighting hardware, lighting equip, filters, dimmer
controls; fabrics, cycloramas; rental service: prefab
scenery

ONAN CORP
1400 73rd Ave NE Minneapolis MN 55432
612 574-5000

Emergency stand-by power generators

OPAMP LABS INC
1033 N Sycamore Ave Los Angeles CA 90038
213 934-3566

Full line audio amps, power supplies, slide
attenuators; ALC & AGC amps, active equalizers &
filters, reverb units VS

OPTEK INC
1390 N McCan St Anaheim CA 92806
714 630-8280

Bulk erasers, demodulators; digital tuners (audio);
video head alignment gauge VS

**OPTIMA ENCLOSURES DIV
SCIENTIFIC-ATLANTA INC**
2166 Mountain Industrial Blvd Tucker GA 30084
404 939-6340

Racks, equip enclosures, cabinets

ORANGE COUNTY ELECTRONICS INTL INC
534 Berry St Winnipeg Manitoba R3E 3H1 Can
204 774-3413

Audio, monitor amps; ALC & AGC amps; AM & FM
compressor/limiters; equalizers & filters (active &
passive); special effects; audio stressors; noise
reduction systems; speakers VS
See ad pg 176—refer to rep/dist section

ORBAN ASSOCIATES INC
645 Bryant St San Francisco CA 94107
415 957-1067; 800 227-4498

Compressor/limiters/filters, FM & AM, equalizers &
filters, active and passive; reverb units; stereo
synthesizer; dynamic sibilance controller; FM
processors; stereo generators VS
See ad pg 95. Contact main office for nearest dealer.

OREGON MAGNETICS
PO Box 13374 Portland OR 97213
503 233-8295

V-lock adaptor for helical scan VTRs

ORROX CORP—See CMX, Videomax

OTARI CORPORATION
981 Industrial Rd San Carlos CA 94070
415 593-1648

Tape duplicators; open reel tape player/recorders
(portable, studio & automated systems) VS
See ad pgs 149, 151, 153—refer to rep/dist section

continued on page 136

slow scan TV, compressed video, narrow band video . . .

TV FACSIMILE

. . . whatever you call it, it will expand your communications capabilities.

CVI systems convert normal TV signals to audio bandwidths, then
transmit single frames of video information via the dial-up
telephone network or dedicated circuits.

- Use standard CCTV cameras & monitors
- Transmission time from 4 to 156 seconds
- Resolution to 512 x 512 pixels
- To 256 levels of gray
- Available in 525 or 625 line standards

Specifications and applications material
cheerfully sent on request.

COLORADO VIDEO, INCORPORATED
Box 928 • Boulder CO 80306 U. S. A. 303/444-3972 • TWX 910-940-3248
Video instruments for data acquisition, processing, transmission, display

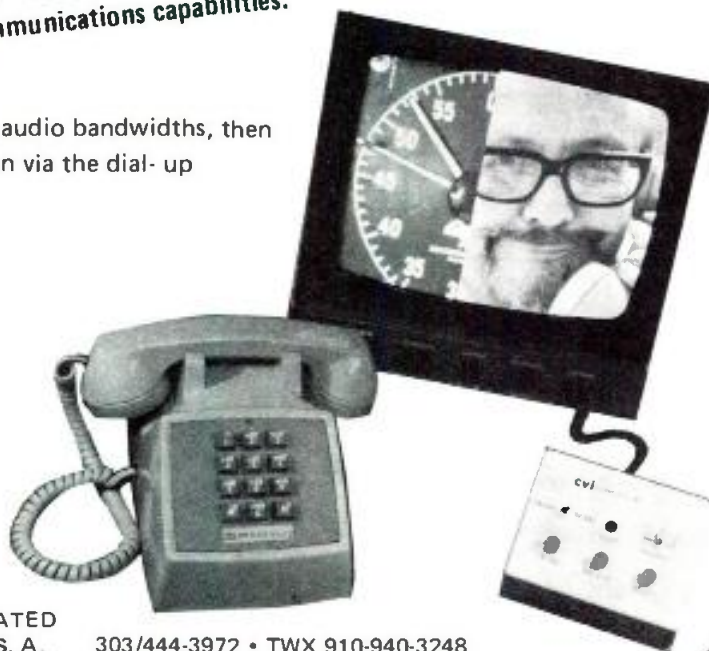

The Source '79

P

PACE WIRE AND CABLE CORP
3590 Oceanside Rd Oceanside NY 11572
516 678-2275
Wire and cable

PACKAGED LIGHTING SYSTEMS INC
PO Box 285 Walden NY 12586
914 778-3515
Lamps, lighting instruments & accessories, dimmer controls, kits, Lucite floors

PACIFIC RECORDERS & ENGINEERING CORP
11100 Roselle St San Diego CA 92121
714 453-3255
Audio switchers; AM & FM compressor/limiters; mono, stereo, audio for TV mixing consoles; line & dist. amps, pre-amps VS

PAKO CORP
6300 Olson Memorial Hwy Minneapolis MN 55410
612 540-6300
Film processors; slide mounting systems

WA PALMER FILMS INC
611 Howard St San Francisco CA 94105
415 986-5961
Motion picture film projectors; video/film transfers and lab services; film cameras VS

PANASONIC CO
One Panasonic Way Secaucus NJ 07094
201 348-7000
Audio amps (pre-amps & power); speakers; tape cartridge player/recorders; cassette player/recorders; open-reel systems; complete line

of cameras (color and mono, portable & studio); lenses and accessories; character/graphics systems; RGB chroma keyers; monitors (b & w, color); pulse & distribution amps; large & small production switchers; SEGs; sync & color bar generators; two VTR editor/controllers VS
See ad pg 45

CA	Pan 8383 Wilshire Blvd Beverly Hills 90211	213 655-1111
GA	Pan #1 Meca Way Norcross 30093	404 923-9700
HA	Matsushita Elec 320 Waiakamilo Rd Honolulu 96817	808 847-5361
IL	Pan 425 E Algonquin Rd Arlington Heights 60005	312 364-7900
MA	Pan 75 University Ave Westwood 02090	617 326-4000
MD	Pan 11 Azar Ct Baltimore 21227	301 247-4300
NY	Pan 50 Meadowlands Pky Secaucus NJ 07094	201 348-7000
PR	Ave 65 de Infanteria Km 9.7 Victoria Ind Pk Carolina 00630	809 769-4320
TX	Pan 1825 Walnut Hill Ln Irving 75062	214 258-2828

PANDUIT CORP
17301 Ridgeland Ave Tinley Park IL 60477
312 532-1800
Nylon cable ties, accessories; plastic wiring duct; terminals; wire markers; electronic connectors VS

PAPERWORK SYSTEMS INC
1609 Broadway PO Box 38 Bellingham WA 98225
206 733-8510 800 426-8872
Automated business systems for radio and TV

PEIRCE-PHELPS INC
2000 N 59 St Philadelphia PA 19131
215 879-7000
TV studio design; information systems

PENTAGON INDUSTRIES INC
4751 N Olcott Chicago IL 60656
312 867-9200
High-speed tape duplicators; audio cassettes

VS MEANS IT'S VERIFIED

PHASECOM CORP
6365 Arizona Circle Los Angeles CA 90045
213 641-3501
RF convertors, modulators & demodulators; programmable video cassette automation systems; quad cartridge/cassette equip automation controllers VS

PHELPS DODGE COMMUNICATIONS CO
Rte 79 Marlboro NJ 07746
201 462-1880
FM antennas; transmission lines; RF filters, coaxial cable

PHILADELPHIA RESINS CORP
20 Commerce Dr Montgomeryville PA 18936
215 855-8450
Non-metallic antenna guys VS
See ad pg 119

PHILIPS AUDIO VIDEO SYSTEMS—See AKG Acoustics

PHILIPS BROADCAST EQUIP CORP
91 McKee Dr Mahwah NJ 07430
201 529-3800

TV cameras, studio & portable; camera lenses & accessories; telecine systems; production switchers, special effect generators; videotape recorders/players, segmented-helical, helical; TBCs; digital noise reducers/filters; audio/video recorder synchronizer, TV transmitters, exciters VS

See ad pgs 110-111

CA	PBEC 3760 Cahuenga Blvd W, N Hollywood 91604	213 766-8185
GA	PBEC 3300 NE Expy Suite 1G Atlanta 30341	404 458-0171
IL	PBEC 7530 Frontage Rd Skokie 60076	312 679-8600
MN	PBEC 15611 Fish Point Rd Prior Lake 55372	612 447-6036
VA	PBEC 14216 Chesterfield Dr Woodbridge 22191	703 494-4998

Useful Bits of Data

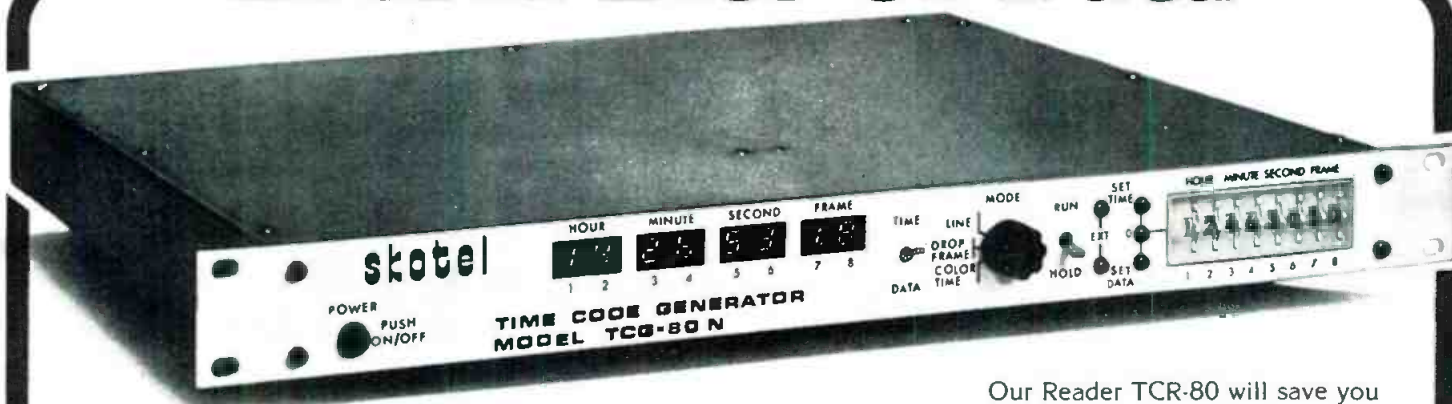

Skotel Time Code Generators and Readers will conveniently and accurately identify audio and video tapes with SMPTE User Data.

The TCG-80N Generator has unique features that meet the growing demand for identifying tapes with start of program sequences, scene/take numbers, official time of sporting events, time countdowns and documentary data.

The User Data memory can be loaded from the thumbwheels or from an external source, and the Data and Time code is displayed on the front panel.

Another feature that can be added to the Generator and Reader is our video character generator. It has an integral insert keyer that can simultaneously insert User Data and Time code into selected positions in the video of a work print or on a monitor.

Our Reader TCR-80 will save you time because it reads User Data and Time code from hand turn reel speed to 40 times play speed.

If we have all this, you can count on Skotel to include all the other features you require in Time code Generators and Readers.

For complete details and application information call . . .

North: Mike Dyer (313) 478-2157 East: Jim Landy (609) 424-4660

South: Gene Sudduth (214) 785-5764

skotel

SKOTEL CORPORATION
1445 Provencher
Brossard, Que.,
Canada J4W 1Z3
(514) 676-1813

Circle 185 on Reader Service Card

PHILIPS TEST & MEASURING INSTRUMENTS INC

85 McKee Dr Mahwah NJ 07430
201 529-3800

Color encoders; sync generators; color video signal & pattern generators; pulse generators; video level meter; decoder; monitor calibrator; RF generators; demodulator; frequency counters; audio generators; video test equip; multi-meters; oscilloscopes; logic analyzers

VS

PLASTIC REEL CORP OF AMERICA
46 Passaic St Wood Ridge NJ 07075

201 933-9125

Reels for video & audio tape, film; film cases, cleaners and editing equipment; racks, cabinets, shipping cases

CONSTANTINE N POLITES & CO
833 Guenther Ave Yeadon PA 19050

215 626-4643

Camera cranes, dollies; lighting heads, stands & fixtures; tower hardware & construction equip

PORTA-PATTERN TELECOMMUNICATIONS INDUSTRIES LTD

6822 Santa Monica Blvd Los Angeles CA 90038
213 461-3561

Test materials, video test charts & slides

VS

POTOMAC INSTRUMENTS INC

932 Philadelphia Ave Silver Spring MD 20910
301 589-2662

Antenna monitors; field intensity meters (AM, FM, TV); intermodulation meters; harmonic distortion meters; patch panels; audio & RF generators; dB meters; phase meters; wow & flutter meters; diff phase-gain measurement; ATS equip.; log printers

See ads pgs 122, 206

VS

POWER-OPTICS INC

1055 W Germantown Pike Fairview Village PA 19409

215 539-5300

Video camera stabilizing systems; remote control

camera mounts; monitor calibrators; animation; production equip rentals

PRODELIN INC

PO Box 131 Hightstown NJ 08520
609 448-2800

VHF & UHF antennas; flexible & rigid transmission line; transmission line connectors; microwave antennas, reflectors, waveguides; satellite antennas

PROGRAMMABLE SYSTEMS INC

6365 Arizona Circle LA CA 90045
213 641-3501

Automated video player systems

PROJECTION SYSTEMS INC

517 Van Houten Ave Passaic NJ 07055
201 473-0180

TV projection systems; large screen projectors

PROTECH AUDIO CORP

PO Box 638 15 Gail Drive Lake Ronkonkoma NY 11727

516 473-5979

Complete line audio amps; slide attenuators & switchers; ALC & AGC amps, active & passive equalizers and filters, reverb units; full line audio consoles

See ad pg 209

VS

PTS ELECTRONICS INC

PO Box 272, 5233 Hwy 37S Bloomington IN 47401

812 824-9331

TV field intensity meters; post production service; hum bucking coils; tools

PULSE TECHNIQUES INC

1411 Palisade Ave Teaneck NJ 07666
201 837-2525

Equalizers & filters, passive

VS

PWH ELECTRONICS LTD

637 College St Toronto Ontario M6G 1B6
416 533-6331

Remote control systems; digital & master clocks,

timers, time distribution systems; complete radio automation systems; radio & TV computer business services

PYRAMID INDUSTRIES INC

PO Box 23169 Phoenix AZ 85063
602 269-6431

Coaxial cable; cable connectors

Q

QEI CORP

Rte 73 Kresson NJ 08053

609 767-8052

AM, FM, stereo modulation monitors; FM exciter; average & peak maximizers; ATS systems; RF amps; receivers; FM transmitters; stereo generators; SCA generator; AM & FM compressor/limiters

See ad pg 156

VS

QRK ELECTRONIC PRODUCTS

1568 N Sierra Vista Fresno CA 93703

209 251-4213 800 344-2181

Consoles (mixers, mono, stereo, audio for TV, portable); disc consoles; patch panels; turntables; pickup arms; turntable pre-amps & controls; speed controls; speakers; studio cabinets & furniture; audio amps (line, pre-amps, monitor); reverb units; digital clocks

See ad pg 137

VS

QSI SYSTEMS INC

993 Watertown St, W Newton MA 02165

617 969-7118

Logging recorders; small production switchers; video identification systems; time lapse video action recorders; digital clocks; master & slave clocks; tape loggers; timers; RF demodulators; time code gens/readers; helical VTR/player; sync gen systems; alphanumeric gens

VS

The Galaxy

The QRK 12-C became the first broadcast standard turntable. We've bred this to become the second.



- Variable Speed Control
 - Slip Cueing
 - D.C. Motor
- Back Cue (no motor drag)
 - Instant Start
- Direct Speed Read-Out on LED
 - Solid State Circuit
 - Remote Start/Stop



CALL TOLL FREE (800) 344-2181

1568 N. Sierra Vista, Fresno, CA 93703

In Calif. call collect (209) 251-4213

The Source '79

Q-TV/TELESYNC

33 W 60th St New York NY 10023
212 765-4200
TV prompter systems VS

QUAD EIGHT ELECTRONICS CORP

11929 Vose St N Hollywood CA 91605
213 764-1516

Audio pre-amps, line & power amps, equalizers; audio controls; audio consoles & mixers; reverb units; LED peak indicators; noise gates; audio digital delay unit; compressor; attenuators; tone oscillators; cabinets, racks

VS MEANS IT'S VERIFIED

QUANTUM AUDIO LABS

1905 Riverside Dr Glendale CA 91201
213 841-0970

Audio mixing consoles (mono, stereo, audio for TV); reverb units VS

QUICK-SET INC

3650 Woodhead Dr Northbrook IL 60062
312 498-0700

Tripods, sands; heads, mounts; dollies for TV, ENG camera braces VS

R

RADIOMETER ELECTRONICS US INC

811 Sharon Dr Cleveland OH 44145
216 871-8900

Audio & RF generators; harmonic distortion meters; wow & flutter meters

RAMKO RESEARCH INC

11355 A Folsom Blvd Rancho Cordova CA 95670
916 635-3600

Audio distribution, line, pre-amp, monitor amps; ALC & A6C amps, active & passive equalizers & filters; mono, stereo, audio for TV, portable, mixing consoles; turntables, turntable pre-amps & controls; speakers; single, dual, multiple cassette & cartridge player/recorders; open-reel portable & studio player/recorders; tape duplicators; bulk erasers; auto loaders; VU & PPM meters; digital clocks & timers VS

See ads pgs 46-47—refer to rep/dist section

RANGERTONE RESEARCH INC

509 Madison Ave New York NY 10022
212 753-5430

Magnetic film recording equipment; film transports; telecine systems; 16mm & 35mm film projectors; slide projectors VS

RANK PRECISION IND INC

411 E Jarvis Ave Des Plaines IL 60018
312 297-7720

Video & film camera lenses and accessories; Varotol lens repair service; complete flying-spot telecine systems VS

See ad pg 157—refer to rep/dist section

CA Rank Prec 5432 W 102 St Los Angeles
90045..... 213 670-6366
NY RPI 260 N Rte 303, N Nyack
10994..... 914 358-4450

RAPID-Q—See Edco Products Inc

RAVEN SCREEN CORP

124 E 124th St New York NY 10035
212 534-8408

Front & rear projection screens VS

RCA AMERICAN COMMUNICATIONS INC

201 Centennial Ave Piscataway NJ 08854
201 885-4400

Satellite transmission services VS

RCA AMERICOM SERVICES INC

60 Broad St New York NY 10004
212 248-2042

Post production services VS

RCA CORP BROADCAST SYSTEMS

Front & Cooper St Bldg 2A Camden NJ 08102
609 338-3000

Audio dist & monitor amps; pre-amps; amplifier power supplies; ALC & AGC amps; compressor/limiters/filters, AM & FM; active equalizers & filters; audio consoles (mixers, mono, stereo, quad, audio for TV, portable); intercom systems; studio cabinets & furniture; single tape cartridge player/recorders; open reel deck studio systems; VU meters; color studio & convertible TV cameras; ENG/EPF cameras; RGB chroma keyers; color correctors & encoders; dropout compensators; film telecine equip (16mm projectors, slide projectors, multiplexers, complete systems, film cart players); frame synchronizers; TBCs; VTRs (quad, helical, segmented-helical, helical cassette, automated systems); VTR head & machine rebuilding; quad cart/cassette equip (players/recorders, automation controllers, reloaded carts); two VTR editor-controllers; computer-assisted editors; time code gens/readers; video identification systems; digital video effects; compressors; magnetic recording equip & accessories; transmitters (AM, FM, VHF, UHF); antennas (AM, FM&TV HP&CP); transmission line

& connectors; mobile van construction; facility turnkey installation VS

See ad pg 40

AL RCA 2244 Center Point Rd Suite 208
Birmingham 35223..... 205 854-3096
CA RCA 330 Primrose Rd Suite
305 Burlingame 94010..... 415 343-2741
RCA Suite 531 6363 Sunset Blvd Hollywood
90028..... 213 461-9171
RCA 2700 W Olive Ave Burbank
91505..... 213 846-2092
CO RCA 777 S Wadsworth Blvd Iron Gate IV
Lakewood 80226..... 303 986-1521
FL RCA 3900 RCA Blvd Palm Beach Gardens
W Palm Beach 33410..... 305 622-1100
GA RCA 3395 NE Expy RCA Bldg Atlanta
30341..... 404 455-3400
IL RCA 1120 W Eastman St Suite 303 Arlington
Hts 60004..... 312 255-2202
IN RCA 2511 East 46th St Suite Q01
Indianapolis 46205..... 317 546-4001
KS RCA 5750 West 95th St Suite III
Overland Park 66207..... 913 642-3185
MA RCA 40 William St Wellesley Office Pk
Wellesley 02181..... 617 237-6050
MI RCA 24333 Southfield Rd Suite 209
Southfield 48075..... 313 569-5880
MN RCA 4601 Excelsior Blvd Suite 305
Minneapolis 55416..... 612 920-6395
MO RCA 7701 Noah's Ark Suite 340
St Charles 63301..... 314 946-7755
NC RCA 5200 Park Rd Suite 125
Charlotte 28209..... 704 525-4870
NJ RCA Front & Cooper Sts Bldg 2-2
Camden 08102..... 609 963-8000
NY RCA 731 James St Rm 200 Syracuse
13203..... 315 478-4195
RCA 1180 Ave of the Americas 22nd Flr
New York 10036..... 212 598-5900
OH RCA 11430 Hamilton Ave Cincinnati
45231..... 513 825-1550
PA RCA 761 N Washington Rd McMurray
15317..... 412 941-5570
TX RCA 3409 Executive Ctr Dr Suite 213
Austin 78731..... 512 345-2224
RCA 8700 Stemmons Freeway Dallas
75247..... 214 638-6200
VA RCA 1901 North Moore St Arlington
22209..... 703 558-4166
WA RCA 1818 Westlake Ave N Suite 222
Seattle 98109..... 206 285-2375
WI RCA Grafton State Bank Bldg Suite 403
101 Falls Rd Grafton
53204..... 414 377-8430

RCA DIST & SPECIAL PRODUCTS DIV

2000 Clements Bridge Rd Deptford NJ 08096
609 541-3636

Camera tubes, receiving tubes, power tubes, SK replacement semiconductors, replacement parts VS

RCA ELECTRO OPTICS & DEVICES

New Holland Ave Lancaster PA 17604
717 397-7661

TV camera tubes, power tubes, display tubes; CCD image sensors; video cameras (mono); camera lenses and accessories; b & w picture monitors VS

Announcing the New PW-200 Pulse Width Measuring Set



The PW-200 generates precision markers which are locked to either station sync or to incoming video. These markers are inserted into incoming video for viewing on a standard B&W picture monitor or television waveform monitor.

VERTICAL or HORIZONTAL mode is selected via front panel switching and front panel controls are used to adjust the position of the markers to the start and finish of the pulse to be measured. The time between markers is computed by the internal 10 MHz clock and is numerically displayed on the LED readout.

STANDARD PW-200 FEATURES INCLUDE:

- Internally generated pulse-cross-allows measurements to be made on any standard B&W monitor.
- Separate, non-interacting controls for vertical and horizontal rate measurements.
- Two isolated outputs—one for pulse-cross monitor display and one to feed a waveform monitor with markers inserted into the video signal.

broadcast video systems ltd.

1050 McNICOLL AVE.
TEL. (416) 497-1020

AGINCOURT, ONT. M1W 2L8
TELEX 065-25329

Unit P, 1050 E. Dominguez St., Carson, Cal. 90746
Tel. (213) 637-2517

Telex 0686-201



evaluating services; videotape rewinders & timers; VTR players/recorders (segmented-helical, helical cassette, automated systems); VTR machine rebuilding VS
 See ad pg 90

REDDING RADIO DIV SJ INDS INC
 Box 344 Fairfield CT 06430
 914 561-4769
 Mic station identification plates; phone loop induction plckups; tape editing blades VS

VS MEANS IT'S VERIFIED

RE-PLAY VIDEO CARTRIDGE SERVICE
 328 Merritt Ave Pittsburgh PA 15227
 412 881-9172
 Reloaded quad VTR cartridges VS

RESEARCH TECHNOLOGY INC
 4700 Chase Lincolnwood IL 60646
 312 677-3000
 Film cleaning & evaluating systems; film editing equipment; videotape storage

REVOX—See Studer-Revox

REYNOLDS/LETERON CO
 13425 Wyandotte St, N Hollywood CA 91605
 213 982-2630
 Character generators VS

RF SYSTEMS INC
 PO Box 428 3100 Communications St Cloud FL 32769
 305 892-6111
 Microwave antennas, receiving antennas; turnkey installation; towers; tower hardware & construction equip

RF TECHNOLOGY INC
 60 Wilton Rd Westport CT 06880
 203 226-8070
 Microwave STLs; portable and ENG microwave equipment VS

RHG ELECTRONICS LABORATORY INC
 161 E Industry Court Deer Park NY 11729
 516 242-1100
 Microwave relay links including portable systems, RF amps

RICHMOND HILL LABORATORIES LTD
 1080 Bellamy Rd Scarborough Ont M1H 1H2
 Canada
 416 431-2953
 Automation equip; chroma keyers; video processing amps; video production & routing switchers; pulse & distribution amps; sync generators; special effects generators

RICHMOND SOUND DESIGN LTD
 1234 W 6th Ave Vancouver BC V6H 1A5
 604 736-7207
 Full line audio mixing consoles

RIVERS ASSOCIATES INC
 Box 58 Leominster MA 01453
 617 537-4821
 Intercom systems, tone detection devices, audio silence alarm, SCA equip, program subcarrier, EBS two tone systems; two-way digital telemetry VS

RIPLEY CO UTILITY TOOL DIV
 46 Nooks Hill Rd Cromwell CT 06416
 302 635-2200
 Misc RF equip; tools; cable installation tools

RMS ELECTRONICS
 50 Antin Place Bronx NY 10462
 212 892-6700
 Coaxial cable passives, connectors, hardware

ROCKLAND SYSTEMS CORP
 Rockleigh Ind Ct Rockleigh NJ 07647
 201 767-7900
 Equalizers/filter (active), audio & RF; sideband analyzers, spectrum analyzers, frequency synthesizers

RCA SERVICE CO
 Dept 2615 Cherry Hill Offices Camden NJ 08101
 609 338-4157

Videotape duplicating service; live & film camera installation & service, TV tape, TV antenna measurement installation & service; teleproduction system design & implementation VS

R-COLUMBIA PRODUCT CO INC
 2008 St Johns Ave Highland Park IL 60035
 312 432-7915
 Self-powered intercom headphones, dynamic & condensor mics

RECORDING SUPPLY CORP
 1233 Rand Rd Des Plaines IL 60016
 312 298-5300
 Empty reels, carts, cassettes; dist. of audio & video magnetic tape, leader tape

RECORTEC INC
 777 Palomar Ave Sunnyvale CA 94086
 408 735-8821
 Audio and video tape cleaners, cleaning and

LISTEC, Distributors of Quality Present:
VINTEN CAMERA MOUNTING EQUIPMENT
 Appearing nightly on everybody's favorite TV program.
 The premier choice, where quality is the goal.

Listec TELEVISION EQUIPMENT CORP. 39 Cain Drive, Plainview, New York 11803
 (516) 694-8963 Telex 640470
 PICTURE COURTESY KCMO-TV

The Source '79

ROCKWELL INTERNATIONAL — See Collins Transmission Systems

RODELCO ELECTRONICS CORP
365A Comac Rd Deer Park NY 11729
516 643-5110
TV & FM translators

ROH CORPORATION
107 Technology Park Norcross GA 30092
404 449-0873
Audio preamps, line, monitor, public address & power amps; audio attenuators; distribution amps, audio routing switchers (all foregoing in modular form); bridging switcher/live monitor; intercom systems; amplifier power supplies **VS**

ROHDE & SCHWARZ SALES CO (USA) INC
14 Gloria Ln Fairfield NJ 07006
201 575-0750
Demodulators; field intensity meters for AM, FM TV; RF power meter; rubidium frequency standards; video test signal generators; VIT distortion meter; waveform monitor, stereo vectorscope, monitor receivers; sideband analyzers; TV translators, video monitors (Barco); antennas, AM, FM and TV, microwave, transmission lines and connectors; b&w and color picture monitors **VS**

ROSCO LABORATORIES INC
36 Bush Ave Port Chester NY 10573
914 937-1300
Lighting, heads, stands, fixtures, diffusion material, gels and filters, set design, lens cleaning tissue

ROSNER TELEVISION SYSTEMS INC
250 West 57th St New York NY 10019
212 246-3967
Radio & TV studio design; finance services; facility turnkey installation; mobile van construction **VS**

ROSS VIDEO LTD
9 Plaza Dr Iroquois ON K0E 1K0
613 652-4889
Large & small production switchers; master control switchers **VS**

RTS SYSTEMS
1100 West Chestnut St Burbank CA 91506
213 843-7022
Intercom systems, interruptible feedback systems; audio mixers; audio dist & power amps; phono pre-amps; dual buffer amp **VS**
See ad pg 118—refer to rep dist section

RUSLANG CORP
247 Ash St Bridgeport CT 06605
203 384-1266
Audio cabinets and furniture **VS**

RUSSCO ELECTRONICS MFG INC
5690 E Shields Ave Fresno CA 93727
209 291-5591
Audio monitor, dist, power amps; pre-amps; audio consoles (mixers, mono, stereo); turntables; turntable pre-amps & controls; pick-up arms **VS**
See ad pg 181—refer to rep dist section

S

SAE (SCIENTIFIC AUDIO ELECTRONICS INC)
01 E Macy St Los Angeles CA 90012
213 489-7600
Audio power amps; active equalizers; electronic crossovers; impulse noise reduction systems **VS**

SADELCO INC
75 West Forest Ave Englewood NJ 07631
201 569-3323
Field intensity meters for TVg calibrators

SAKI MAGNETICS INC
5770 Uplander Way Culver City CA 90230
213 649-5983
Audio and video magnetic tape heads, new and refurbished; VTR head refurbishing **VS**
See ad pg 187—refer to rep dist section

SANSUI ELECTRONICS
1250 Valleybrook Ave Lyndhurst NJ 07071
201 460-9710
4-channel & stereo encoder; turntables; preamps; power amps; reverb units; audio accessories

SAWYER CAMERA CO
6820 Santa Monica Blvd Hollywood CA 90038
213 466-6111
TV studio design; rental and distribution of complete line of film production and post production equip, tripods, wireless mics, cameras, lenses, film projectors **VS**

SC ELECTRONICS—See Audiotechnics Video Display

SCALA RADIO
PO Box 4580 Medford OR 97501
503-779-6500
Broadcast antennas

KEN SCHAFER GROUP INC
10 E 49 St New York NY 10017
212 371-2335
Audio special effects, reverb units, delay lines; digital broadcast delay for obscenity deletion; intercom systems; wireless mics; custom music synthesizers; audio spectrum analyzers; duplex wireless com systems **VS**

VS MEANS IT'S VERIFIED

SCHNEIDER CORP OF AMERICA
185 Willis Ave Mineola NY 11501
516 747-5100
Video camera lenses; motion picture camera lenses; lens accessories **VS**

SCIENTIFIC-ATLANTA INC
3845 Pleasantdale Rd Atlanta GA 30340
404 449-2000
Demodulators; exciters; modulators; transmit/receive, receive only satellite earth stations **VS**

SCIENTIFIC RADIO SYSTEMS INC
367 Orchard St Rochester NY 14606
716 458-3733
FM transmitters, RF receivers, comm & monitor; audio power amps; HF receivers

SCIENTIFIC SYSTEMS INC
191 Westfield Ave Clark NJ 07066
201 381-1088
Audio distribution amp

HH SCOTT INC
20 Commerce Way Woburn MA 01801
617 933-8800
Audio analyzers; audio cassette player/recorders

SCOTT INSTRUMENTS LABORATORIES
533 Main St Acton MA 01720
617 263-3263
Sound level meters

L J SCULLY MANUFACTURING CORP
138 Hurd Ave Bridgeport CT 06604
203 368-2332
Tape deck reproducers, disc cutting equip

SCULLY RECORDING INSTRUMENTS — See Ampro/Scully

SEACOR INC
123 Woodlawn Ave Westwood NJ 07675
201 666-5600
Capacitors

SENCORE INC
3200 Sencore Dr Sioux Falls SD 57107
605 339-0100
Field intensity meters; sweep generators for VHF, UHF, FM, & chroma; field effect meters; dual-trace oscilloscopes; AM/FM stereo analyzer; power supplies; voltmeters, multimeters, oscilloscopes; frequency monitors & counters; automatic TV monitors; transistor testers

SENNHEISER ELECTRONIC CORP
10 W 37th St New York NY 10018
212 239-0190
Mics (dynamic, condenser, wireless, shotgun, lavalier); booms & dollies; mic accessories **VS**

SEQUERRA CO
143-11 Archer Ave Jamaica NY 11435
212 297-5000
Broadcast monitor; FM intensity meters, modulation monitors

SESCOM INC
1111 Las Vegas Blvd Las Vegas NV 89101
800 634-3457
Audio line & power amps; pre-amps; op-amp modules; amp power supplies; ALC & AGC amps; active equalizers & filters; audio direct boxes, mic-splitters & snakes **VS**

SETCOM CORP
1400 Stierlin Rd Mountain View CA 94043
415 965-8020
Headphones & intercom systems **VS**

SGL WABER ELECTRIC
300 Harvard Ave Westville NJ 08093
609 456-5400
Plugs and connectors, multiple outlet electrical fixtures, utility carts

SHALLCO INC
Hwy 301 S PO Box 1089 Smithfield NC 27577
919 934-3135
Audio rotary attenuators

continued on page 142

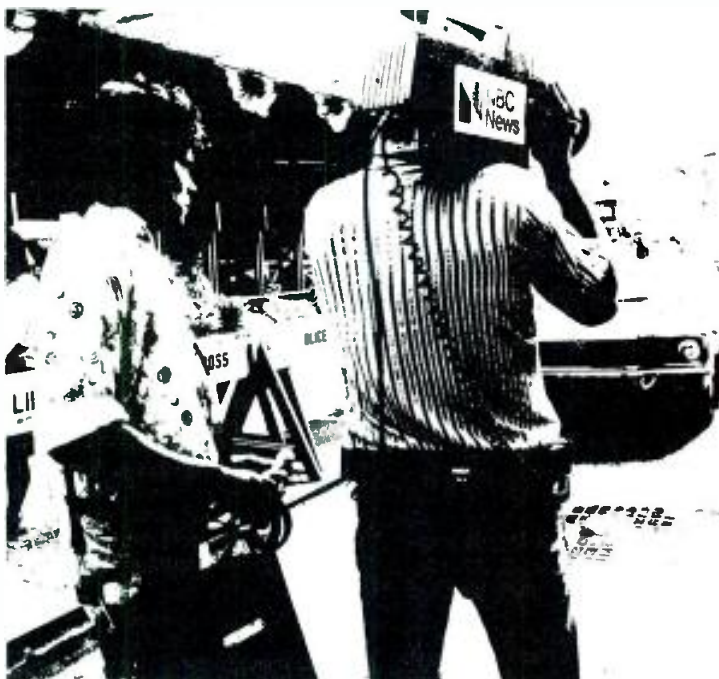

THE UNCOMPLICATED CONSOLE

Compare the sensible panel layout of these broadcast mixers to the cluttered array of tiny buttons, midget knobs and closely spaced faders on other mixers costing much more. Ours are easier to operate and understand.

Compare the sensible electronic packaging, with only 2 kinds of electronic modules used. That's redundancy! Plus, such standard features as 4 inch log taper slide pots, selectively illuminated VU meters, mono output, electronic audio switching, 2-way remote control and, of course, our furniture quality oiled walnut end panels and armrest.

Three expandable models to choose from: SYSTEM 16 (illustrated) is priced at \$8,250 with 8 mixers (expandable to 16) with 3 metered stereo outputs and 1 metered mono output. Additional mixers \$365 each. Delivery? Stock to 3 weeks.

GET UNCOMPLICATED!

**BROADCAST
AUDIO ASSOCIATES**

11355 PYRITES WAY
RANCHO CORDOVA, CA 95670
(916) 635-1048

See us in NRBA Booth 401/403/500

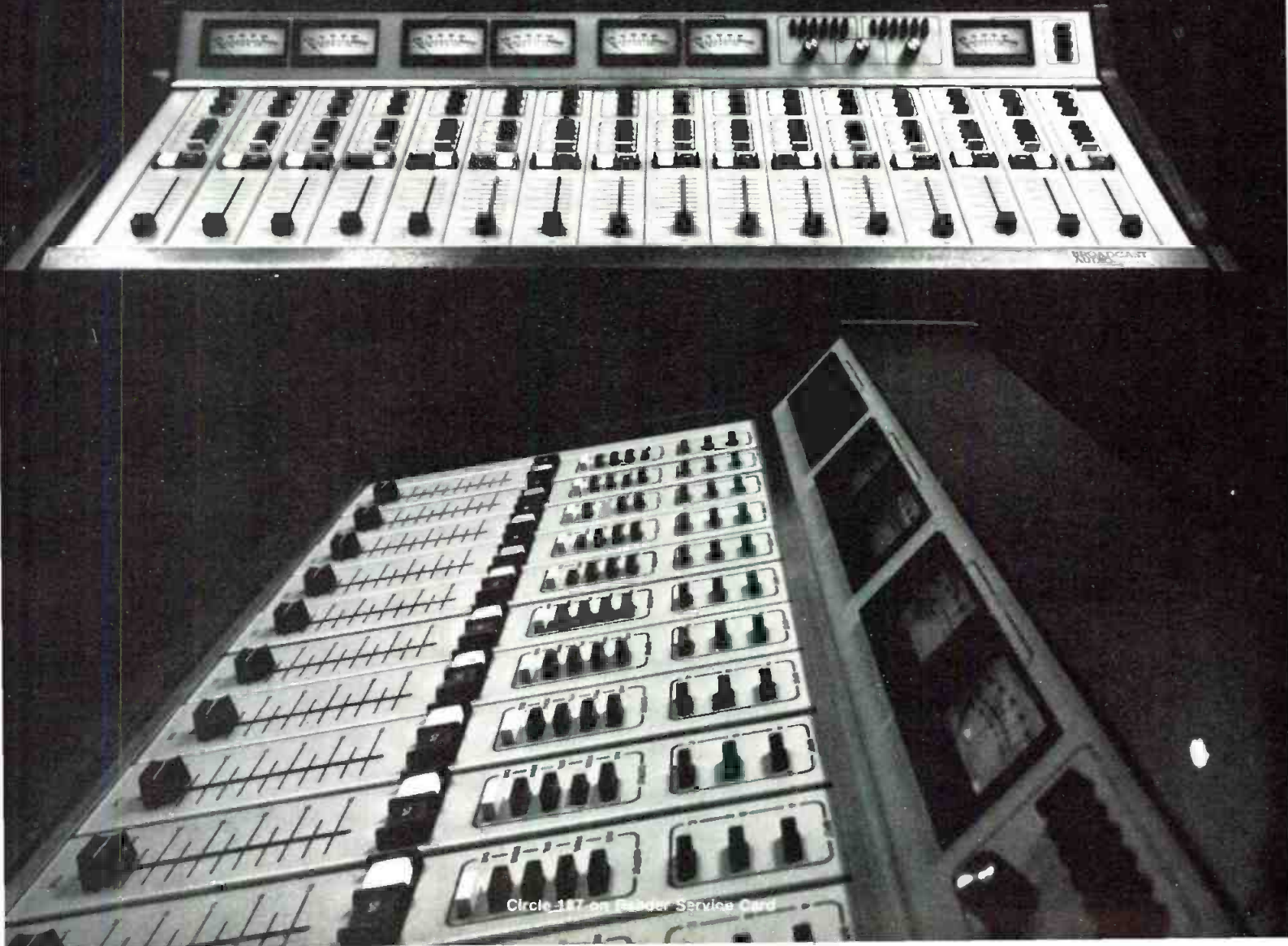

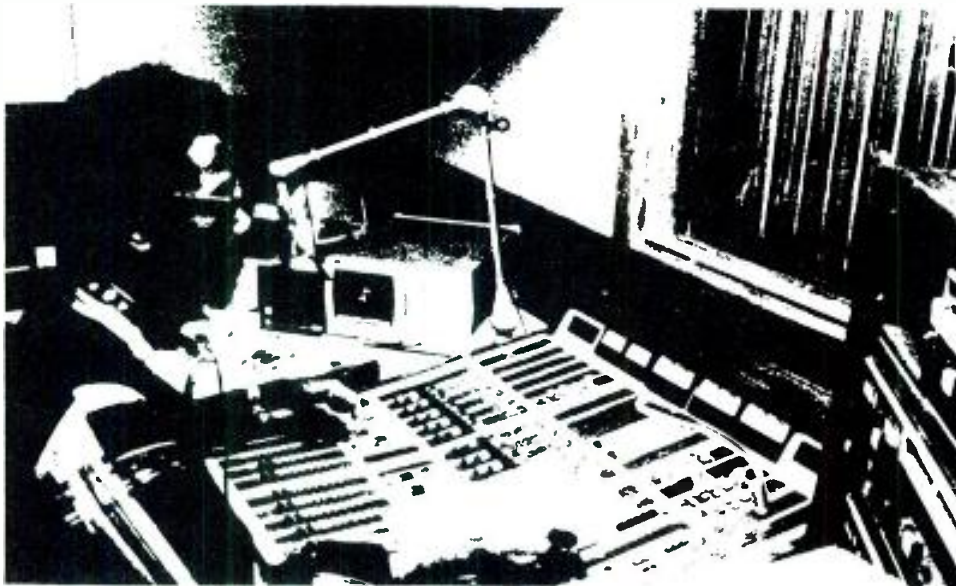

SHAREPOINT SYSTEMS INC
402 Tenth Ave Haddon Heights NJ 08035
609 546-1841; 212 625-7333

Audio pre-amps; dist. line & PA audio amps; computer microprocessor controllers; memory units; read out/display; data input devices; auto loggers; complete automation systems; intercom systems; manual audio tape editing equip & accessories; PPM level indicators; video presence detectors; SCA equip.; program subcarriers; dB meters; log printers; status & alarm indicators; radio studio design

SHARP ELECTRONICS CORP
10 Keystone Place Box 588 Paramus NJ 07652
201 265-5600

Audio power amps; turntables; speakers; cassette tape player/recorders; studio cameras; studio/field convertible cameras; ENG/EPF cameras; mono cameras; lenses & accessories; color monitors; SEGs; sync, color bar & black burst generators; helical cassette VTR **VS**

See ad pgs 54-56

CA	Sharp 1047 Carson Blvd Torrance 90502.....	213 830-4470
GA	Sharp 6478 Interstate 85 Norcross 30093.....	404 448-5230
IL	Sharp 430 E Plainfield Rd La Grange 60525 312 482-9292.....	312 482-9292
VA	Sharp 2341 Jefferson Hwy Arlington 22202.....	703 521-6570

SHIBADEN—See Hitachi Denshi

SHINTRON CO INC
144 Rogers St Cambridge MA 02142
617 491-8700

Video moduline consoles; production switchers, SEGs; sync generator systems (sync, color bar, black burst); character generators; alphanumeric generators; video pulse & subcarrier amps; encoded & luminance chroma keyers; time code gens/readers; audio dist. amps **VS**

See ad pg 156

VS MEANS IT'S VERIFIED

SHIVELY LABS INC
Rt 302 Raymond ME 04071
207 655-3841

TV & FM antennas; transmission line & connectors; diplexers; RF filters & loads **VS**

SHURE BROTHERS INC
222 Hartrey Ave Evanston IL 60204
312 866-2200

Dynamic, condenser, ribbon, lavalier mics and accessories; audio mixers & pre-amps; pick up arms, stereo & quad pickups, turntable pre-amps & controls; FM compressor/limiters/filters; active equalizers & filters **VS**

See ad pg 85—Call or write main office for nearest rep.

SIEGEL ELECTRONICS
PO Box 33421 San Diego CA 92103
714 295-4995

Video processing amps with image enhancement, color correction; helical capstan servo TBCs **VS**

SIEMENS CORP
186 S Wood Ave Iselin NJ 08830
201 494-1000

Gas-filled surge voltage lighting protectors for cable amps & power supplies

SIGMA ELECTRONICS INC
1830 State St E Petersburg PA 17520
717 569-2681

Video amps (pulse, distribution, subcarrier); sync & black burst generators; sync pulse changeover; audio dist amps; passive video switchers

SIMPAC INTERNATIONAL INC
5472 Kenilworth Dr Huntington Beach CA 92649
714 846-0765

Storage systems for carts

SINGER EDUCATION SYSTEMS
3750 Monroe Ave Rochester NY 14603
716 586-2020

16mm projectors; slide projectors; filmstrip projectors; sound slide projectors/videors

SINGER PRODUCTS CO INC
1 World Trade Center Suite 2365 New York NY 10048
212 432-1400

Transmitters AM & FM; FM antennas; studio equip

SINTRONIC CORP
212 Welsh Pool Rd Lionville PA 19353
215 363-0444

AM & FM broadcast transmitters; exciters **VS**

See ad pg 118

SITCO ANTENNA CO
10330 NE Marx St Portland OR 97220
503 253-2000

TV antennas; antenna preamps; antenna towers & accessories; wired cable; connectors

SKIRPAN LIGHTING CONTROL CORP
61-03 32 Ave Woodside NY 11377
212 274-7222

Light control systems (manual, automated, dimmer packs); patch terminals **VS**

SKOTEL CORP
1445 Provencher Brossard Que J4W 1Z3 Can
514 676-1813

Time code generators and readers; digital metronome **VS**

See ad pg 136

SMITH-VICTOR CORP
Lake & Colfax St Griffith IN 46319
219 838-6136 800 345-9862

Lighting systems, heads, stands, fixtures, diffusion material

THE WARREN R SMITH CO
110 E Point Pleasant Ave PO Box 324 Ocean Gate NJ 08740
201 269-6795

Camera lens adaptors (motion picture lenses to video cameras); telecine positioner; film to video transfer; custom optical mechanical systems **VS**

SOLADYNE INC
7447 Convoy Ct San Diego CA 92111
714 279-7872

Microwave communications equip

SOLID ELECTRONICS LABORATORIES
49 Fairfield Rd Havertown PA 19083
215 446-4799

FM transmitters, exciters, SCA generator; stereo gen; RF program subcarrier **VS**

SOLL INC
401 E 74 St New York NY 10021
212 988-0290

Emergency power systems, mobile van construction; RF control systems, radio and TV studio design; facility turnkey installations; RF switchers/duplexers; transmission line & connectors **VS**

SONAR RADIO CORP
3000 Stirling Rd Hollywood FL 33021
305 981-8800

Videotape bulk erasers; mobile two-way radios and pagers **VS**

See ad pg 186—refer to rep/dist section

SONO-MAG CORP/SMC
1005 W Washington St Bloomington IL 61701
309 829-6373

Tape decks, single, dual, multiple, time delay; automation equip, sequencers, time insertion, controllers, memory units, reel decks, multi-cart machines, auto loggers, tone generators, auto time/weather announcers, complete systems **VS**

SONTEC ELECTRONICS
10120 Marble Court Cockeysville MD 21030
301 628-2283

Audio line amps, pre-amps, dist. op-amp modules; AM&FM limiter/compressors; equalizers & filters (active); mixing consoles

SONY VIDEO PRODUCTS BROADCAST DIV
9 W 57th St New York NY 10019
212 371-5800

ENG/EPF cameras; TBCs; one inch helical VTRs (studio & portable); broadcast VCRs; time code gens.; two VTR editor-controllers; wireless mics **VS**

See ad pgs 4-5, 51

CA	Sony 700 West Artesia Blvd Compton 90220.....	213 537-4300
IL	Sony 6801 West Jarvis Street Niles 60648.....	312 792-3600

SONY VIDEO PRODUCTS CO
9 W 57th St New York NY 10019
212 371-5800

Half-inch & 3/4-inch VCRs; A/V videotape recorder/players; b & w, color monitors; portable b & w & color cameras; video projection systems; small production switchers; sync generators; SEGs; two VTR editor-controllers; one-inch, 3/4-inch, & 1/2-inch videotape & accessories; complete studio systems **VS**

SOUND DYNAMICS INC
PO Box 32055 San Jose CA 95152
408 926-3588

Open-reel tape studio systems **VS**

SOUNDSCRIBER MAGNETIC RECORDING CO INC
85 Willow St New Haven CT 06511
203 624-5179

Audio logging recorder with associated heads, reels, bulk eraser **VS**

SOUND TECHNOLOGY
1400 Dell Ave Campbell CA 95008
408 378-6540

Audio generators; harmonic distortion meters, intermodulation meters **VS**

See ad pg 27—refer to rep/dist section

continued on page 144

When you need microphones with "reach," reach for these!

CL42S Shotgun System

The CL42S reaches farther and rejects more ambient noise than any other shotgun of its size ever made. Our exclusive line bypass port makes it more directional at low frequencies so you won't have to sacrifice frequency response when you use it on a boom. Diffraction vanes maintain high-frequency directivity to preserve uniform frequency response if the "talent" gets a little off-mike.

Phantom or AB powered, the CL42S comes complete with windscreen, shock mount, carrying case and handle for hand-held applications. And it's rugged.

CH15S Hypercardioid System

The CH15S is actually more directional than a mini shotgun mike – in a package that's only 4 inches long that weighs less than 6 oz. Specially designed for boom and fishpole use in TV and motion picture studios, but equally at home wherever working space is small and you have need for a compact, highly directional microphone.

Compatible with phantom or AB power, the CH15S comes complete with windscreen, shock mount and carrying case. And, this microphone is rugged.

The Electro-Voice Warranty

Electro-Voice backs up these two microphones with the only unconditional warranty in the business: for two years we will replace or repair your CL42S or CH15S microphone, when returned to Electro-Voice for service,

at no charge – no matter what caused the damage!

We can do this because we build these microphones to meet our standards for performance, ruggedness and durability. We accept nothing less, and if you're a professional, buying a professional quality microphone, you shouldn't either.

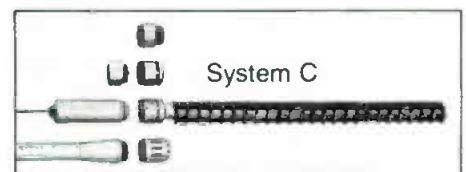

EV **Electro-Voice**[®]
a gulton company

600 Cecil Street, Buchanan, Michigan 49107

Circle 190 on Reader Service Card

www.americanradiohistory.com

The Source '79

SPARTA ELECTRONICS CORP

5851 Florin-Perkins Rd Sacramento CA 92828
916 383-5353

AM & FM transmitters; audio amps; audio cartridges; audio consoles & mixers; tape cartridge recorder/players; tape erasers; turntables; arms; monitor speakers; duplexers; exciters; remote control equip; SCA equip; FM antennas, antenna monitors; modulation monitors; status & alarm indicators

SPECTRA SONICS

3750 Airport Rd Ogden UT 84403
801 392-7531

Audio consoles; full line of audio amps, slide attenuators, pan controls; tone generators; speakers; compressor/limiters; variable equalizers; electronic crossover filters; audio attenuators & accessories VS

SPHERE ELECTRONICS

20201 A Prairie Ave Chatsworth CA 91311
213 349-4747

Audio consoles, mixers, program amps, equalizers

SPIN PHYSICS INC (A KODAK CO)

3099 Science Park Rd San Diego CA 92121
714 453-5410

Replacement heads for VTRs, quad head refurbishing VS

See ad pg 199

AL	K Harrell 2518 Excalibur Dr Huntsville 35803	205 881-2610
CA	K Thompson 1969 Scott Lane Los Altos 94022	415 961-7794
CA	C May 1608 Tiffany Way San Jose 95125	408 448-1422
CA	E Gehie 1286 Camino Patomero Santa Barbara 93111	805 964-3316
KS	B Keegan 3059 SW 45 St Topeka 66605	816 221-8327
MD	J Bailey PO Box 661 Laurel 20810	301 776-5666
MD	K White 420 Kiskonko Turn Oxen Hill 20022	301 839-3218
MN	B Boyd RR#2, Box 213 Prior Lake 55372	616 447-5824
TX	L Koonsman 1414 Northridge Carrollton 75006	214 245-1816

STAINLESS INC

Third Street & Montgomery Ave N Wales PA 19454

215 699-4871

AM antennas; antenna towers; tower lighting, tower accessories VS

See ad pg 102

STANCIL-HOFFMAN CORP

921 N Highland Ave Hollywood CA 90038
213 464-7461

Auto loggers for audio; open reel logging recorders; tape loggers

STANDARD ELECTRIC TIME

89 Logan St Springfield MA 01101
413 732-1141

Electronic master clocks; tape timers

STANDARD TAPE LABORATORY INC

26120 Eden Landing Rd#5 Hayward Ca 94545
415 786-3546

Audio test tapes, test magnetic film

STANTON MAGNETICS

175 Terminal Dr Plainview NY 11803
516 681-0200

Headphones; stereo phono pickups; turntables, arms; turntable preamp/equalizer; audio pre-amps VS

See ad pg 203

STANTRON DIV WYCO METAL PRODUCTS

6914 Beck Ave N Hollywood CA 91605
213 875-0800

Racks, cabinets, furniture VS

STATION BUSINESS SYSTEMS

8616 La Tijera Blvd Los Angeles CA 90045
213 642-2211

Computer business services for radio and TV VS



STOREEL CORP

2050-C Carroll Ave Ste Z Atlanta GA 30341
404 458-3280

Cabinets & racks for equip; storage racks & enclosures for tape reels; film storage; storage equip & mobile units for video tape, film cassettes, audio carts VS

STRAND CENTURY INC

20 Bushes Ln Elmwood Park NJ 07407
201 791-7000

Lighting hardware & accessories; light dimmer controls; patch terminals; plugs & connectors VS

STUDER REVOX AMERICA INC

1819 Broadway Nashville TN 37203
615 329-9576

Audio tape recorder/players; audio consoles; power amps, amp power supplies; condenser mics VS

STUDIO FILM & TAPE INC

6424 Santa Monica Blvd Hollywood CA 90020;
630 9th Ave New York NY 10036
213 466-8101; 212 977-9330

On-line performance monitors (DOM); dist of film, mag film, new & reconditioned videotape, editorial leaders & supplies VS

See ad pg 210

SUPERLEX ELECTRONICS CORP

151 Ludlow St Yonkers NY 10705
914 965-6906

Headphones, intercom headphones with mics; audio switching console

SUPERSCOPE INC

20525 Northoff Chatsworth CA 91311
213 998-9333

Condenser mics; speakers; audio tape, open reel & cassette; tape player/recorders, cartridge (single & dual), cassette, open reel VS

SURCOM ASSOCIATES

305 Wisconsin Ave Oceanside CA 92054
714 722-6162

Vacuum capacitors, mica capacitors VS

SWITCHCRAFT

5555 N Elston Chicago IL 60630
312 792-2700

Audio plugs, jacks, connectors; cable assemblies, tester, tape deck comparitors, mixers VS

SWR INC

PO Box 215 Goffstown NH 03045
603 497-3000

Transmission line & accessories; RF cable & connectors; TV antennas VS

SYSTEM ASSOCIATES

6117 Reseda Blvd Ste 205 Reseda CA 91335
213 344-3552

Dist of used TV equip (routing switcher, tape cleaners, character generators, time code generators, etc.) VS

SYSTEM CONCEPTS INC

395 Ironwood Dr Salt Lake City UT 84115
801 486-3833

Character generators VS

See ad pg 20

OH System Concepts 16006 Waterloo Rd
Cleveland 44110

216 692-3410

VS MEANS IT'S VERIFIED

SYSTEMS MARKETING CORP—See Sono-Mag Corp

SYSTRON DONNER

2750 Systron Dr Concord CA 94518
415 676-5000

Digital clocks, time distribution systems; frequency monitors & counters; RF generators; voltmeters, multimeters, dB meters; multitest systems; microwave equipment components; SMPTE time code generators/readers VS

SYSTRON DONNER CORP MICROWAVE DIV

14844 Oxnard St Van Nuys CA 91409
213 342-1107

RF generators, spectrum analyzers VS

T

TA (TRACK AUDIO INC)

33753 9th S, Federal Way WA 98003
206 838-4460

Audio pre-amps; ALC & AGC amps, special effects, AM compressor/limiters; consoles (mixers, stereo, portable); turntable pre-amps & controls; single cart players/recorders; VU & PPM indicators; timers; spectrum analyzers VS

TABER MFG & ENG CO

2081 Edison Ave San Leandro CA 94577
415 635-3831

Replacement audio heads for VTR & audio recorder/players; audio & VTR bulk erasers; VTR head refurbishing, replacement & rebuilt video tape heads VS

See ad pg 184

JOEL TALL—See Elpa Marketing

TANDBERG OF AMERICA INC

Labriola Court Armonk NY 10504
914 273-9150

Open reel recorder/players; cassette recorder/players; speakers; monitor amps & receivers VS

TAPCO (TECHNICAL AUDIO PRODUCTS CORP)

3810 148th Ave NE Redmond WA 98052
206 883-3510

Audio power amps; active equalizers and filters, reverb units; audio consoles (mono, stereo); speakers VS

TAPE-ATHON CORP

502 S Isis Ave Inglewood CA 90301
13 776-6933

Tape recorders/players (reel-to-reel); playback equip for automation, timers; mono & stereo music service

TAPECASTER TCM INC

PO Box 662 Rockville MD 20851
301 881-8888

Tape cartridge equip; digital timers; programmers; clocks; amps; tape timers; audio carts

continued on page 146

DYNAMIC NEW DIMENSIONS IN VISUAL PRESENTATION —with General Electric Professional Large Screen TV Projection



IN BUSINESS—General Electric projectors display real-time computer-generated data for Merrill Lynch Government Securities, New York.

General Electric professional large screen television projectors—displaying color or monochrome pictures up to 25 feet wide—bring new dimensions of presentation impact to a broad spectrum of applications.

A wide choice of new and improved color and monochrome models is available to meet specific requirements for television display applications, in standard or high brightness, for various scan standards.

The color projectors utilize General Electric's exclusive single optical path light valve. All color information is projected simultaneously in one light beam. This system eliminates time-consuming registration of three separate images, which is required for all other color television projectors.

These projectors can display any size television picture from two feet to 25 feet wide, with high resolution and contrast over their full range of light output.



IN ENTERTAINMENT—General Electric color projector brings large screen race action to Ontario Jockey Club, near Toronto, Ontario, Canada.

Among the primary applications of the projectors are: **Medical and Dental Education.** Technique and procedural training.

Business. Sales meetings, industrial training, product presentations, real-time display of computer-generated data, teleconferences.

Aerospace and Defense. Situation displays, simulator training.

Entertainment. Theatre television and closed-circuit TV events, overflow crowds, discotheque special effects.

Television Production. Backgrounds for news programs, special effects, data display, program previewing.

Call or write: General Electric Company, Video Display Equipment Operation, Electronics Park 6-206, Syracuse, NY 13221. Phone: (315) 456-2562/2533/2179.

GE Professional Large Screen Television Projector Specifications

COLOR PROJECTORS

Model	Light Output in Lumens			Resolution* in Lines per Picture Height		Input Power Req.		Scan Standards***	Video Input**
	Open Gate, Min.	Modulated TV, Min.	Modulated TV, Typ.	Min. Horiz.	Min. Vert.	Watts	Volt-Amps.		
PJ 5000	550	220	280	750	300	1200	1600	525 li./60 fps; 625 li./50 fps	(1)
PJ 5050	1250	500	650	750	300	1600	2150	525 li./60 fps; 625 li./50 fps	(1)
PJ 5800	550	200	280	750	600	1200	1600	875 lines, 60 fps	(2)
PJ 5850	1250	500	650	750	600	1600	2150	875 lines, 60 fps	(2)
PJ 5100	550	200	280	750	650	1200	1600	1023 lines, 60 fps	(2)
PJ 5150	1250	500	650	750	650	1600	2150	1023 lines, 60 fps	(2)

MONOCHROME PROJECTORS

PJ 7000	1000	600	750	800	400	1000	1350	525 li./60 fps; 625 li./50 fps	(3)
PJ 7050	1700	1000	1250	800	400	1000	1350	525 li./60 fps; 625 li./50 fps	(3)
PJ 7055	3300	2000	2400	800	475	1500	2000	525 li./60 fps; 625 li./50 fps	(3)
PJ 7800	1000	600	750	800	650	1000	1350	875 lines, 60 fps	(3)
PJ 7850	1700	1000	1250	800	650	1000	1350	875 lines, 60 fps	(3)
PJ 7855	3300	2000	2400	800	650	1500	2000	875 lines, 60 fps	(3)
PJ 7100	1000	600	750	800	750	1000	1350	1023 lines, 60 fps	(3)
PJ 7150	1700	1000	1250	800	750	1000	1350	1023 lines, 60 fps	(3)
PJ 7155	3300	2000	2400	800	750	1500	2000	1023 lines, 60 fps	(3)

Line Power. All Projectors: 117 or 240 v., ± 10%, 50/60 Hz

*Resolution measurements made with wide-band video input.

**Video Input Key: (1) NTSC or RGB. (2) RGB. (3) Wide-Band.

***For use at other scanning rates, contact General Electric (VDEO) for special application/model information.

GENERAL  **ELECTRIC**

Circle 191 on Reader Service Card

The Source '79

TAPEX CORP

228 Fifth St Suite 2, W Des Moines IA 50265
515 274-3087

Audio tape carts, cassettes, test tapes; empty reels, carts, cassettes; leader tape; tension gauges; alignment gauges; replacement tape heads; head degaussers; bulk erasers; tape storage

TAYBURN ELECTRONICS

6106 Avenida Encinas Carlsbad CA 92008
714 438-5444

Microwave systems (intercity, ENG & portable); remote pickup & remote control systems; receivers; RF amps, filters, switchers; phasing network; microwave antennas VS

TDK ELECTRONICS

755 Eastgate Blvd Garden City NY 11530
516 746-0880

Open reel, cartridge, cassette, pancake, test audio tape; videotape; videotape cleaners VS

TEAC CORP OF AMERICA

7733 Telegraph Rd Montebello CA 90640
213 726-0303

Open-reel & cassette audio tape recorders/reproducers; mono & stereo mixing consoles; audio monitors; pre-amps & power amps; mics VS

TECH ELECTRONICS INC

6000 Peachtree Rd NE Atlanta GA 30341
404 455-7626

Videotape editing controller

TECH LABORATORIES INC

Bergen & Edsall Blvds Palisades Pk NJ 07650
201 944-2221

Rotary & slide attenuators; fixed pads; video attenuators; RF attenuators; gain measurement VS
See ad pg 205—refer to rep/dist section

TECHNICAL AUDIO PRODUCTS CORP — See Tapco

TECHNICS BY PANASONIC

One Panasonic Way Secaucus NJ 07094
201 348-7000

Turntables; direct-drive tape decks; cassette players; pre-amps, power amps; equalizers; mics; peak/average meters; speakers VS
See ad pg 72

TECHNISPHERE CORP

215 E 27 St New York NY 10016
212 889-9170

Equip rental & sales; post production services; electronics design services; repair services

TECHNOLOGY SERVICE CORP

2217 Purdue Ave Los Angeles CA 90064
213 473-6741

Weather radar systems VS

TEKTRONIX INC

PO Box 500 Beaverton OR 97077
503 644-0161

Oscilloscopes, picture monitors, spectrum analyzers; demodulators; sideband analyzers; waveform monitors; video test generators, sync, color bar, black burst, staircase/ramp, multiburst, pulse/bar generators; audio generators; voltmeters, multimeters; VITS & VIR systems & equip; diff phase/gain measurement; video test, charts & slides, vectorscopes; monitor photometers; video processing amps; repair service; frequency monitors & counters; A-D/D-A converters VS

TELAUTOGRAPH CORP

8700 Bellanca Ave Los Angeles CA 90045
213 641-3690

Fascimile equip VS

TELE-CINE INC

5434 Merrick Rd Massapequa NY 11758
516 798-2828

Film and TV lenses and accessories (Schneider); camera stabilizing systems VS

TELECTRO SYSTEMS CORP

9618 43 Ave Corone NY 11368
212 651-8900

Public address systems, single & dual tape recorder/players for instrumentation; speakers

TELEDYNE BIG BEAM

290 East Prairie Crystal Lake IL 60014
815 459-6100

Emergency lighting

TELEDYNE CAMERA SYSTEMS

131 N 5th Ave Arcadia CA 91006
213 359-6691

Video to film recording systems; optical equip

TELEDYNE ENERGY SYSTEMS

110 W Timonium Rd Timonium MD 21093
301 252-8220

Power supplies for remote applications

TELEMATION DIV OF BELL & HOWELL

3485 W 2100 S, Salt Lake City UT 84119
801 972-8000

Monitor, power, dist audio amps; audio switchers; time insertion sequencers; computer controllers; auto time weather announcers; integral head ENG/EFP cameras; TV mono cameras; lenses & accessories; character/graphics systems; alphanumeric generators; image enhancers; digital noise reducers/filters; color encoders; multiplexer & complete film telecine systems; b & w picture monitors; video processing amps; pulse, dist, & subcarrier amps; production switchers; routing switchers; special effects generators; sync, color bar, black burst, & digital sync decoder generator systems; computer-assisted video editing equip; bulk erasers; digital synthesizer & animation video effects; automated light control systems; hum bucking coils; news info systems VS
See ad pgs 83, 163

CA C Olson 1247 N Glasswell Orange
92667..... 714 997-0790
CA J Kubit 1601 Civic Cntr Dr
Santa Clara 95050..... 408 984-6727
IL D Spindle 2411 Howard St Evanston
60202..... 312 491-1169
OH G Morrison 112 E Main St Lancaster
43130..... 614 653-4244
OK J Richardson 1532 Valley View Dr
Claremore 74017..... 918 341-9066
UT D Rhodes N Bennett 3485 W 2100 S
Salt Lake City 84119..... 801 972-8000

TELE-MEASUREMENTS INC

145 Main Ave Clifton NJ 07014
201 473-8822

Test slide projectors; TV camera alignment slides for b/w & color; TV slide light boxes; TV equip rental/repair; studio/van design

TELEMET

185 Dixon Ave Amityville NY 11701
516 842-2300

Audio dist & monitor amps; audio switchers; RGB chroma keyers; image enhancers; color encoders; pulse & dist video amps; small production switchers; routing switchers; signal equalizing systems; color bar, staircase/ramp, multiburst generators; RF demodulators & modulators; fiber optics transmitters & receivers; demodulators; sideband analyzers; spectrum analyzers; video test generators VS

See ad pg 28

NY R Griffiths 185 Dixon Ave Amityville
11701..... 516 842-2300
TX B Culbertson..... 214 387-1389

TELESCRIPT INC

20 Inslay St Demarest NJ 07627
201 567-2220

Monitor prompting systems VS

TELESTRATOR — See Interand

TELEVISION EQUIPMENT ASSOCIATES (TEA)

Box 260 S Salem NY 10590
914 763-8893

Headphones; intercom systems; dynamic mics; audio & video tape cleaners; video monitor calibrators; videotape rewinder; video delay lines & filters; video equalizer; tape cleaning & evaluating VS

TELEVISION PRODUCTION SERVICES CORP

30 W Maple Ave Boundbrook NJ 08005
201 469-5743

Set design; equipment rental; production VS

TELEVISION PRODUCTS CO INC

9016 Aviation Blvd Inglewood CA 90301
213 776-3276

Booms & dollies for mics; camera pedestals; portable video camera power packs; batteries, battery chargers VS
See ad pg 154

TELEVISION TECHNOLOGY CORP

5970 W 60th Ave Arvada CO 80003
303 423-1652

RF amps, attenuators, converters, filters, loads; FM & TV translators; FM & UHF transmitters; TV combiners, RF cables VS
See ad pg 204

TELEX COMMUNICATIONS INC

9600 Aldrich Ave S Minneapolis MN 55420
612 884-4051

Audio amps (pre-amps & power); relay & time insertion sequencers, open-reel decks, auto loggers, multi-cart machines; headphones; intercom systems; tape carts; empty reels, carts, cassettes; open-reel cart, & cassette player/recorders; logging recorders; tape duplicators VS
See ad pg 123—refer to rep/dist section

TELONIC/BERKELEY

PO Box 277 Laguna Beach CA 92652
714 494-9401

Test instruments; RF attenuators; sweep generators, RF filters, microwave sub-systems; impedance bridges; dB meters VS

continued on page 149



Heard Altec's latest?



It's another dynamic performance.

We're not bragging. Building sound systems with superb dynamic performance has been our profession for over 40 years—we wouldn't settle for anything less. Straight fact.

If your profession is centered around spending long hours in a broadcast studio, you can't afford to be distracted or fatigued by poor quality audio. You've got to have the best, distortion-free equipment available. Clean. Clear. Dynamic.

At Altec, we make a wide range of top quality

sound equipment—microphones, remote mixers, equalizers, monitors—that will help make a pleasure out of your demanding profession.

For further information on how Altec can add dynamic performance to your studio's sound system, write to: Altec Sound Products Division, Commercial Sales Dept.

Location photography courtesy of KEZY Radio, Anaheim, Ca.

1515 S. Manchester Ave., Anaheim, Calif. 92803 • 714/774-2900
ALTEC CORPORATION

Circle 192 on Reader Service Card

ALTEC

the sound of experience

12X. 18X. 25X. ZOOM!

And over a dozen other ways to make
any camera look its best.

Whatever your camera, production goals and budget, it pays to talk to Canon first. Because we offer you more to choose from. And more *value*, whatever your choice — in full servo or manual models for ENG/EFP, studio or field.

To give you greater versatility, there's the widest choice of focal lengths and longest zoom ratios. For greater sensitivity,

larger relative apertures. For flexibility, shorter MODs, lighter weight and more compact size. (Often, at a surprisingly compact price.) All, backed by fast, *dependable* factory service.

Whether you're buying a new camera or upgrading your present one, give us a call.

And discover why more people depend on Canon.

Canon®

Canon U.S.A. Head Office 10 Nevada Drive, Lake Success, N.Y. 11040 (516) 488-6700 • 140 Industrial Drive, Elmhurst, IL 60126 (312) 833-3070
123 Paularino Avenue East, Costa Mesa, CA 92626 (714) 979-6000
Canon Optics & Business Machines, Canada, Ltd., 3245 American Drive, Mississauga, Ontario L4V 1B8, Canada
Canon Amsterdam N.V., Industrial Products Division De Boelelaan 8, Amsterdam, Netherlands



Circle 193 on Reader Service Card

The Source '79

TENTEL CORP

50 Curtner Ave Cambell CA 95008
408 377-6588
Audio & video tape tension gauges VS

See ad pg 206

TEPCO CORP

PO Box 680 Rapid City SD 57701
605 343-7200
TV & FM translators; FM boosters; comm. & monitor receivers; microwave equip VS

TERRACOM DIV OF CONIC CORP

9020 Balboa Ave San Diego CA 92123
714 278-4100
Microwave STLs; intercity, portable & ENG microwave equip; receive only satellite earth stations; microwave antennas VS

See ad pg 155

TEXAS ELECTRONICS INC

PO Box 7225 Inwood Sta Dallas TX 75209
214 631-2490
Meteorological monitoring equip

TEXSCAN CORP

2446 N Shadeland Ave Indianapolis IN 46219
317 357-8781
RF switchers, filters; signal generators, sweep generators; oscilloscopes; spectrum analyzers; impedance bridges; tunable filters; VHF/UHF tuner test equip, test accessories & terminators

THE TEXWIPE CO

51 Prospect Place Hillsdale NJ 07642
201 664-0555
Head & tape cleaning & evaluating products VS

THALNER ELECTRONIC LABS

7235 Jackson Rd Ann Arbor MI 48103
313 761-4506
Character generators; pulse & distribution amps; sync generators, screen splitters, video identification systems, digital clocks; video time & data gens; video counter/timers

THEATRE TECHNIQUES INC

60 Connolly Pkwy Hamden CT 06514
203 281-6111
Audio mixers; intercom systems; manual & automatic light dimmer controls; patch terminals VS

THERMODYNE INTL LTD

12600 Yukon Ave Hawthorne CA 90250
213 679-0411
Reusable shipping & handling containers; racks VS

THOMSON-CSF ELECTRON TUBES

750 Bloomfield Ave Clifton NJ 07015
201 779-1004
RF power tubes, vacuum tubes, UHF/VHF tetrodes & circuits, UHF klystron VS

THOMSON-CSF LABORATORIES

37 Brownhouse Rd Stamford CT 06902
203 327-7700
Audio dist amps; ALC & AGC amps; AM & FM compressor/limiters/filters; active equalizers & filters; noise reduction systems; color studio cameras; studio/field convertible cameras; ENG/EFP cameras; character/graphics generators; RGB chroma keyers; image enhancers; digital noise reducers/filters; color correctors; frame synchronizers; colorizers; video film noise reducers; video, multiplexer, encoder & decoder VS

See ad pg 15

CA	M Clayton 1919 W Magnolia Blvd Burbank 91506	213 849-2188
CT	F Shufelt 37 Brownhouse Rd Stamford 06902	203 327-7700
SA	B Mills 522 S Lee St Americus 31709	912 924-8309
MO	H Caplan 396 Chez Paree Dr St Louis 63042	314 831-3320
TX	M McGreevy 11911 Sixth St Alief 77072	713 495-3195
VA	A Audick 8519 Buckboard Dr Alexandria 22308	202 296-9189

VS MEANS IT'S VERIFIED

THOMSON-CSF LGT DIV
75 Rockefeller Plaza New York NY 10019
212 977-2214
TV translators; UHF & VHF transmitters VS

THOR ELECTRONICS CORP

321 Pennsylvania Ave Linden NJ 07036
201 486-3300
Power tubes & rectifiers

TIFFEN MFG CORP

90 Oser Ave Hauppauge NY 11787
516 273-2500
Filters optical effects attachments for cine & TV camera lenses VS

TIME & FREQUENCY TECHNOLOGY INC

3090 Oakmead Village Dr Santa Clara CA 95051
408 246-6365
Microwave STLs; remote control systems; data acquisition & logging systems; RF modulators; FM translators; program subcarriers; demodulators; field intensity meters (AM, FM, & TV); log printers; modulation monitors; status & alarm indicators; automatic TV monitors, calibrators VS

See ad pg 75—refer to rep dist section

TIMES WIRE & CABLE CO

358 Hall Ave Wallingford CT 06492
800 243-6904
Cable & wire; fiber optics cables & links; CATV systems

TM SYSTEMS INC

25 Allen St Bridgeport CT 06604
203 366-4571
Line amps, amp power systems, VU meters, dB meters; conditioning equip

TOPAZ ELECTRONICS

3855 Ruffin Rd San Diego CA 92123
714 279-0111
Power supply converters, uninterruptible power systems, power isolators, surge protectors

TOWNSEND ASSOCIATES INC

PO Box 1122 Westfield MA 01085
413 562-5055
Demodulators, diplexers, exciters, RF amps; HV power supplies for TV transmitters, TV transmitters; vacuum contactors; TV transmitter maintenance service VS

TORPEY CONTROLS & ENGINEERING LTD

70 Milner Ave Unit 5 Scarborough ONT M1S 3P5 Canada
416 751-1067
Single-wire remote control systems; digital clocks, master & slave clocks VS

TOSHIBA CORP BROADCAST ELECTRONICS SYSTEMS DIV

292 Gibraltar Drive Sunnyvale CA 94086
408 734-9172
Color TV studio cameras; ENG/EFP portable TV cameras; portable field production switcher
See ad pg 109
GA Toshiba 2971 Flowers Rd S Atlanta 30341 404 289-8905

TRANSIST-O-SOUND INC

728 Yosemite Dr Indianapolis IN 46217
317 897-1549
ALC and AGC amps, portable mixer amps, recording amps for mag sound on film VS

TRANS-LUX CORP

625 Madison Ave New York NY 10022
212 751-3110
Rear projection screens
VS
TRANSTECTOR SYSTEMS
PO Box 11159, Zephyr Cove NV 89448
800 648-3387
Transient surge protectors

TREISE ENG INC

1941 First St San Fernando CA 91340
213 365-3124
Motion picture color and B/W film processors & film processor accessories VS

continued on page 151

OTARI MX-5050-B BROADCAST RECORDER



Otari's new MX-5050-B continues the proud heritage of the MX-5050 Series, a recorder now extensively used by television and radio broadcasters worldwide. The new version has all the proven features of the earlier pace setter, including front adjustable bias and record EQ, built-in test oscillator, edit and cue, splicing block, motion sensing, selective reproduce, and adds many new features all its own: ultra reliable TTL switching, noise free inserts, three speeds in field-selectable pairs of 15/7½ or 7½/3¾ ips, 24 dBm headroom with 28 dBm output into 600 ohms, dc capstan servo with ± 7% speed control (to match program length to a time slot), peak reading LED plus standard full sized VU meters, return to zero memory, and LED function indicators, among others.

Add these features to a 66 dB S/N ratio and a frequency response from 30 to 22,000 Hz ± 2 dB at 15 ips and you have a machine that competes with those costing thousands of dollars more.

Compare features and benefits, compare performance, compare our track record for reliability. Call Ruth Pruett at 415/593-1648.

PREFERRED
BY PROFESSIONALS

OTARI

WORLDWIDE

Otari Corporation
981 Industrial Road
San Carlos, California 94070
415/593-1648 TWX 910-376-4890
Circle 194 on Reader Service Card

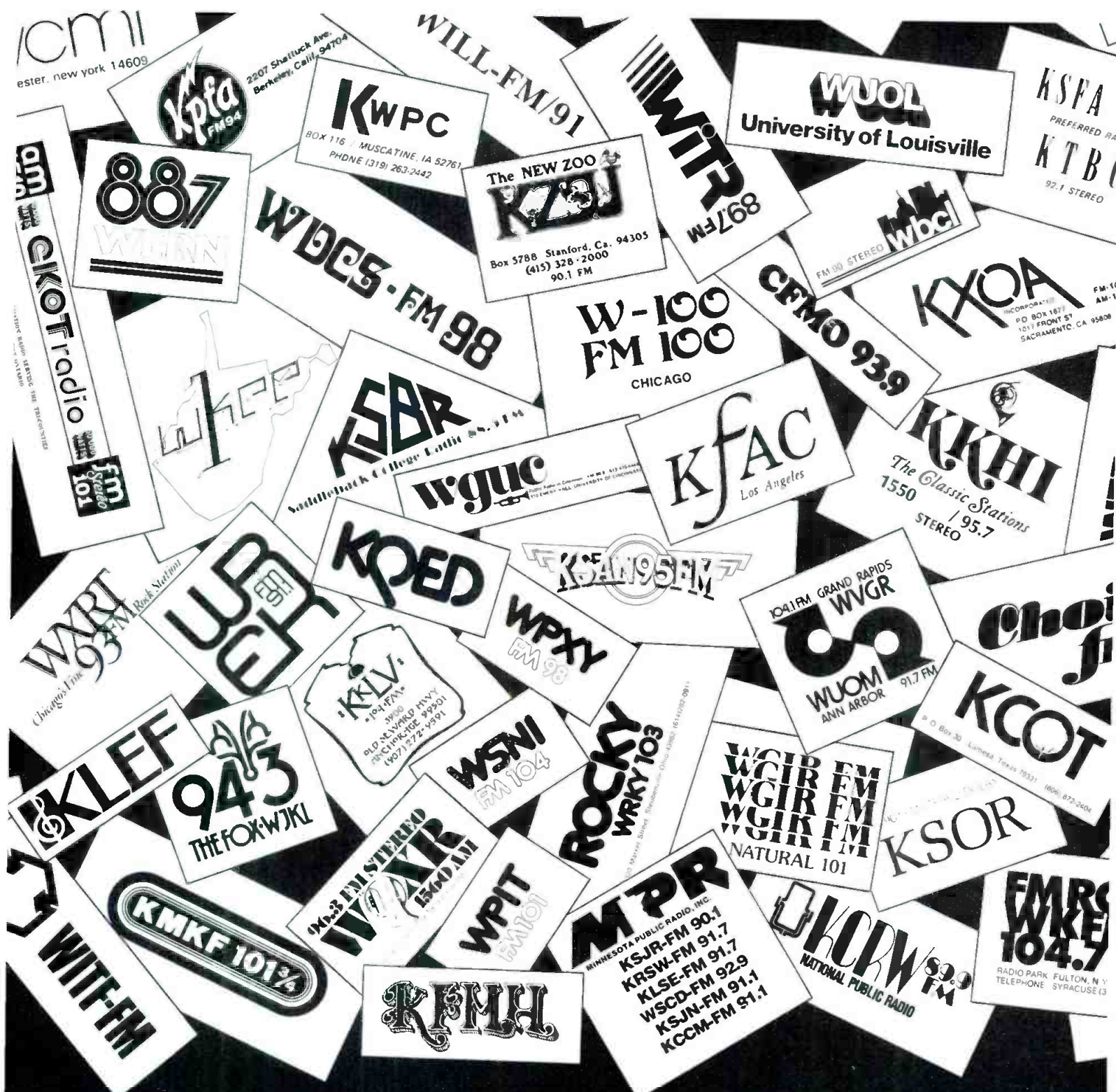

DOLBY FM: QUALITY CALL LETTER

These stations, and many others, broadcast Dolby FM. Their engineers know the difference Dolby FM makes in sound quality, and their managers know how widely recognized the name Dolby is among today's sound-conscious listeners.

But not everyone has heard the difference Dolby FM can make. That's why at the NRBA convention Dolby Labora-

tories will be conducting brief demonstrations of the Dolby FM system.

Hear the difference for yourself. Discuss with us the possibility of your broadcasting Dolby FM experimentally, without obligation. In time you too may want to add your call letters to the growing list of Dolby FM broadcasters.

Hear the difference: Dolby at NRBA Washington D.C. October 7-10
The Dupont Suite, located on the Terrace Level, one floor above the Exhibit Hall.



'Dolby' and the double-D symbol are trademarks of Dolby Laboratories
731 Sansome Street, San Francisco, CA 94111
Telephone (415) 392-0300. Telex 34409
Circle 195 on Reader Service Card

The Source '79

TREPAC CORP OF AMERICA
30 W Hamilton Ave Englewood NJ 07631
201 567-3810
Audio/video automatic line program alarm

TRI-EX TOWER CORP
7182 Rasmussen Ave Visalia CA 93277
209 625-9400
Self-supporting, guyed towers; portable towers

TRIPLETT CORP
1 Triplett Dr Bluffton OH 45817
419 358-5015
VU & dB meters; voltmeters; multimeters VS

TRI-TRONICS INC
4019 Tujunga Ave N Hollywood CA 91604
213 877-9912
Production equip rental, post-production services, studio design, radio and TV; mobile van construction, facility turnkey installation, color video monitor; video tape/film recording transfer

TROMPETER ELECTRONICS INC
8936 Comanche Ave Chatsworth CA 91311
213 882-1020
Coax patching equip; RF attenuators; cables, connectors; custom cable assemblies; coax cable; electro/optical connectors VS

TRUE TIME INSTRUMENT CO
3243 Santa Rosa Ave Santa Rosa CA 95401
707 528-1230
Satellite synchronized clock; clocks & time systems, time distribution; SMPTE time code equip. VS

TT ELECTRONICS INC
2212 Barry Ave Los Angeles CA 90064
213 478-8224
RF inductors, RF filters, audio & video filters, intermodulation distortion measurement filters

TWEED AUDIO INC
1640 Fifth St Santa Monica CA 90401
213 394-5159
Audio amps (power & dist.); AM & FM compressor/limiters/filters; complete line audio consoles VS
See ad pg 183—refer to rep/dist section

2005AD INC
2005 Naudain St Philadelphia PA 19146
215 545-3488
Audio consoles, VU meters

U

UHF ASSOCIATES
4600 Muniz Ranch Rd PO Box 24 Jenner, CA 95450
707 632-5580
RF modulators, CCTV switcher

ULTRA AUDIO PIXTEC
BOX 921 Beverly Hills CA 90213
213 276-2726
Radio, TV, recording studio design; waveform monitors; vectorscopes; VCR bridge; audio amplifiers; audio mixers; color charts VS

UMC ELECTRONICS CO SENSTROL DIV
460 Sackett Pt Rd North Haven CT 06473
203 288-7731
Relay sequencers; computer/microprocessor controllers; multi-cart machines; complete automation systems; audio consoles (mixers, stereo, audio for TV); tape cart player/recorders (single, dual, multiple); replacement tape heads; bulk erasers, head degaussers; tape cartridges VS
See ad pg 14—refer to rep/dist section

UNARCO-ROHN DIV OF ROHN IND INC
PO Box 2000 Peoria IL 61656
309 697-4400
Towers, hardware and construction equip; tower lighting VS

UNIMEDIA
Rte 2 PO Box 2574 E Auburn CA 95603
916 272-1971
Color picture monitors

UNION CONNECTOR CO INC
149 Babylon Tpk Roosevelt NY 11575
516 623-7461
Lighting patch terminals; heavy duty plugs/connectors VS

UNITED RESEARCH LABS
681 Fifth Ave New York NY 10022
212 751-4663
Op-amp audio modules; auto-fac open-reel player/recorders; replacement parts for open-reel audio decks

UNI-SET DIV OF KNIFF WOODCRAFT CORP
449 Ave A Rochester NY 14621
716 544-3820
Modular studio set design VS

UNI-SYNC
71 Chapel St Newton MA 02195
617 964-3210
Audio power amps; audio consoles (mixers, mono & stereo) VS

UNITED MEDIA INC
1571-D Parkway Loop Tustin CA 92680
714 731-3011
Two VTR editor-controllers; computer-assisted editor; time code generators; audio/video recorder synchronizer VS

UNITED RECORDING ELEC IND (UREI)
8460 San Fernando Rd Sun Valley CA 91352
213 767-1000
Audio line amps & pre-amps; amplifier power supplies; compressor/limiters, AM & FM; active equalizers & filters; delay lines; mono, stereo, quad, audio for TV consoles; turntable pre-amps & controls; speakers; VU meters; chart recorders; audio generators; spectrum analyzer VS
See ad pg 107—refer to rep/dist section

VS MEANS IT'S VERIFIED

UNITED SYSTEMS CORP (DIGITEC)
918 Woodley Rd Dayton OH 45403
513 254-6251
Frequency counters, counter-timers; digital clocks; digital voltmeters; frequency converters, frequency synthesizers; pulse, sine, square-wave generators; time base generators; status and alarm indicators VS

US JVC CORP
58-75 Queens Midtown Expy Maspeth NY 11378
212 476-8300
Video color cameras; portable video cameras; lenses, camera accessories; videotape recorders/players; monitors; videotape; video cassette players; video editor-controller; mics VS
See ad pgs 70-71

CA	US JVC Corp 1011 W Artesia Blvd Compton 90220	213 537-6020
IL	US JVC Corp 2250 Lively Blvd Elk Grove Village 60007	312 364-9300
TX	US JVC Corp 3400 So Loop E Houston 77021	713 741-9470

US PIONEER ELECTRONICS CORP
85 Oxford Dr Moonachie NJ 07074
201 440-8100
Tape recorders; headphones; mics; stereo monitor receivers; speakers VS

UTAH SCIENTIFIC INC
2276 So 2700 W, Salt Lake City UT 84119
801 973-6840
Video, audio & tally routing switchers VS
See ad pg 60—refer to rep/dist section

UTILITY TOWER CO
3200 NW 38th PO Box 12369 Oklahoma City OK 73157
405 946-5551
AM antennas; towers; tower hardware & construction equip, and lighting; transmission line & connectors VS

continued on page 153

OTARI MARK II BROADCAST RECORDER



A second generation recorder incorporating all the field-proven Otari features plus several new items of special interest to broadcasters. These include: modular transport and electronics for convenient console, rack or portable mounting, plug-in cards for ease of maintenance, splicing block, complete accessibility to all electronics adjustments for fast bias and record/reproduce alignment, variable speed ($\pm 7\%$) dc capstan servo to precisely match program length to a specific time slot, and interface jack for dbx or Dolby noise reduction switching. Standard Otari features include true professional quality and reliability, motion sensing, selective reproduce on all channels, 19 dBm headroom, XLR connectors, edit and cue, and built-in test oscillator. Available in two-channel 1/4-inch or four-channel 1/2-inch models.

Compare features and benefits, compare performance, compare our track record for reliability. Call Ruth Pruett at 415/593-1648.

**PREFERRED
BY PROFESSIONALS**

OTARI®

WORLDWIDE

Otari Corporation
981 Industrial Road
San Carlos, California 94070
415/593-1648 TWX 910-376-4890
Circle 196 on Reader Service Card

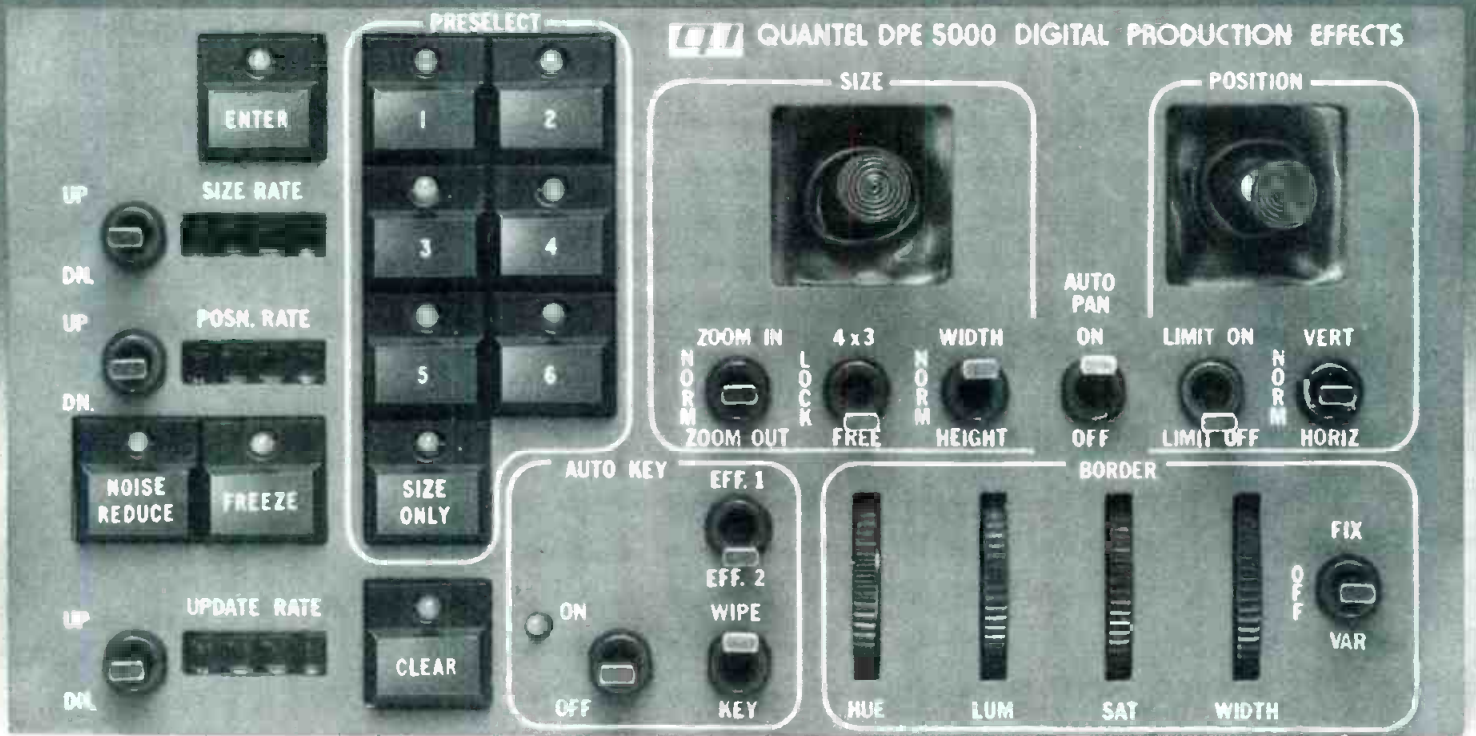

Production control panel of the DPE 5000.

SOME PEOPLE GIVE YOU DIGITAL EFFECTS. WE GIVE YOU DIGITAL EFFECTS WITH OPTICAL QUALITY.

There's good reason why the Quantel DPE 5000 is the world's most widely used system for digital effects: optical quality.

The DPE 5000 produces effects that are smooth, realistic, virtually indistinguishable from optical effects. Good enough to be used live on the air. With confidence.

A full-fledged minicomputer and several microprocessors handle millions of digital manipulations that make Quantel effects more camera-like.

And our unique production control panel, shown above, gives the operator "extra hands" to smoothly control operation and bring into play the marvelous range of DPE 5000 effects. Automatic functions, programmed routines, and fail-safe limits simplify control

and eliminate constant planning and anticipation.

With the DPE 5000, you can actually expand the power of your switcher. (It can be easily interfaced to *any* switcher.) You can preselect effects — shapes, sizes, positions, even transition rates from one effect to the next.

Using optional NO-BLANK noise reduction/blanking correction feature, you can salvage tapes that don't meet FCC blanking requirements.

The net effect of Quantel digital effects is a better, more exciting picture on the air — and a better, more rewarding bottom line.

For more details, call your nearest MCI/Quantel representative. Or get in touch with us directly:

Micro Consultants, Inc.,
P.O. Box 10057, Palo Alto,
California 94303, 415/321-0832.

MCI/QUANTEL



The digital video people

Circle 197 on Reader Service Card

The Source '79

V

VACUUM TUBE INDUSTRIES INC
35 Pequit St Box 358 Canton MA 02021
617 828-1650
Vacuum power tubes, rebuilt VS

VALAD ELECTRIC HEATING CO
160 Wildey St Tarrytown NY 10591
914 631-4927
Electric heaters for mobile vans & stations

VAMCO ENGINEERING
11104 E 56 St Tulsa OK 74145
918 252-4142
Digital tape timers; clock systems; A/V dist. amps;
videotape timer (also for ENG & TVC); A/V routing
switcher; chroma-key kit

VAN LADDER INC
Box 709 Spencer IA 51301
800 831-5051
Aerial lifts VS

VARIABLE SPEECH CONTROL CO
185 Berry St San Francisco CA 94107
415 495-6100
Speed controlling modules (speech compressors,
pitch correctors) for film & tape; audio cassette
player/recorders VS

VARIAN ASSOC ELECTRON DEVICE GROUP
611 Hansen Way Palo Alto CA 94303
415 493-4000
See also EIMAC
Audio power amps & pre-amps; video pulse amps;
diplaxers, exciters & modulators; intercity
microwave equip; RF amps, attenuators, filters &
loads; satellite earth stations; UHF transmitters; RF
& vacuum tubes; rectifiers VS

VARIAN/BEVERLY MICRO-LINK PRODUCTS
8 Salem Road Beverly MA 01915
617 922-6000
ITFS & MDS microwave & systems; microwave RF
components, assemblies & subsystems; exciters,
modulators, TV translators VS

VEGA DIV OF CETEC
PO Box 5348 El Monte CA 91731
213 442-0782
Wireless mic systems; wireless mic accessories VS
See ad pg 31—refer to rep/dist section

VERSA COUNT ENGINEERING
553 Lively Blvd Elk Grove Village IL 60007
312 593-0208
Video processing amps; FM and TV translators; FM
transmitters; exciters; RF amps; modulation
monitors; audio dist. amps VS

VIDEO AIDS CORP OF COLORADO
325 E 7th St Loveland CO 80537
303 667-3301
Test demodulators; cross pulse generators; H
phase, burst phase, VIRS phase meters;
vectorscopes; VITS, VIR systems; hum bucking
solators; audio dist amps & amp power supplies;
audio for TV mixing consoles; intercom systems;
c&w & color picture monitors; video dist amps; sync,
black burst & gen lock generators; two VTR
editor/controller, audio/video recorder
synchronizer; video presence detector VS
See ad pg 202—refer to rep/dist section

VIDEO DATA SYSTEMS
10 Oser Ave Hauppauge NY 11787
516 231-4400
Character generators; TV titling & data display
systems VS

VIDEOMAX DIV OF ORROX CORP
1303 Scott Blvd Santa Clara CA 95050
108 988-2000
Rebuilt video recording heads & headwheel
assemblies; replacement heads VS
See ad pg 3

CA R Murphy 316 19 Pl Manhattan Beach
90266..... 213 980-7927
GA F. Benson 107 Tulip Tree Terr
Peach Tree City GA 30269..... 404 992-4490
NY R Holmes 800 Riverside Dr New York
10032..... 212 947-8031

VIDEOMEDIA
250 N Wolfe Rd Sunnyvale CA 94086
408 733-6500
Computer-assisted & two VTR editing systems VS
See ad pg 115

VIDEO MODULAR SYSTEMS
3317 Brunel Dr Oakland CA 94602
415 848-2693
Video special effects system with synthesizer,
colorizer, repositioner, animation

VIDEO OPTICS
1916 Old Middlefield Way Mountain View CA
94043
415 965-4298
Low light level camera

VIDEO PRODUCTION SERVICES
1442 San Pablo Ave Berkeley CA 94702
415 526-6741
Rental of mobile production units; computerized
post-production service

VIDEO SPECIALTIES
PO Box 136 Solana Beach CA 92075
714 481-0073
Custom automated master control & automation
systems VS

THE VIDEO TAPE CO
10545 Burbank Blvd N Hollywood CA 91601
213 985-1666
Videotape, tape cleaning & evaluating; tape
duplication & distribution services VS

VIDEOTEK INC
125 N York St Pottstown PA 19464
215 327-2292
Color & dc portable picture monitors VS
See ad pg 106
AZ 9625 N 21st St Dr
Phoenix 85021..... 602 997-7523

VIDTRONICS
855 N Cahuenga Blvd Hollywood CA 90038
213 466-9741
Film to tape transfer; all post production services for
videotape

VIF INTERNATIONAL
Box 1555 Mt View CA 94042
408 739-9740
Vacuum tube replacements & adaptors; audio deck
clutch replacement kits; rebuilt & replacement
heads; capstan idler assemblies; reel retainers;
graphic equalizers; reverb systems; mixing
consoles; background music tape player,
stereo/mono intermix unit; band pass filters;
microphones (Pearl); facility turnkey installation;
dist. of full line professional audio products VS

VIKRON
520 Blanding Wood Rd S St Croix Falls WI 54024
715 384-3233
Magnetic tape heads VS

VINTEN—See Listec

VISCOUNT INDUSTRIES LTD
105 E 69th Ave Vancouver BC V5X 2W9
604 327-9446
Video production switchers; distribution amps;
routing switchers; sync generator systems VS
See ad pg 132

VISUAL INFORMATION INSTITUTE INC
PO Box 33 Xenia OH 45385
513 376-4361
Sync generator systems, video test materials and
generators; monitor calibrators VS

VISUAL METHODS INC
35 Charles St Westwood NJ 07675
201 666-3950
CCTV lenses & accessories, CCTV microwave
system VS

ARS-1000 AUTOMATED RADIO STATION REPRODUCER

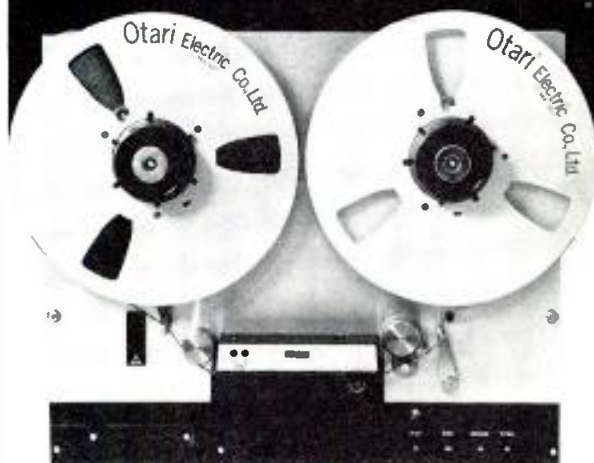

Widely used in leading automation systems. Specifically designed to meet their stringent requirements for highest audio performance, long term reliability and around-the-clock operation. Basically, the ARS-1000 is a work horse two-channel stereo reproducer with two tape speeds (7½ and 3¾ ips) and the following features: heavy duty 19-inch top plate, head mounted pre-amp to minimize hum, RFI and yield superior S/N, special long-life polyurethane pinch roller tire, friction reducing ball bearings, heavy duty motor and brake assemblies, and gold plated PCB connectors. It's easy to maintain with its plug-in PCB's and mother board configuration, easy-access flip-up head cover, and front adjustable output level and head azimuth (to minimize stereo phasing errors). Its operating features include remotable Play and Stop, a ready light to indicate proper tape threading, head lifters for fast modes, a cue control for audible monitoring, and optional 25 Hz cue tone sensor. All connections are brought out to a single 25 pin Cinch connector.

Compare features and benefits, compare performance, compare our track record for reliability. Call Ruth Pruett at 415/593-1648.

**PREFERRED
BY PROFESSIONALS**

OTARI®

WORLDWIDE

Otari Corporation
981 Industrial Road
San Carlos, California 94070
415/593-1648 TWX 910-376-4890

Circle 198 on Reader Service Card

BM/E SEPTEMBER, 1979 153

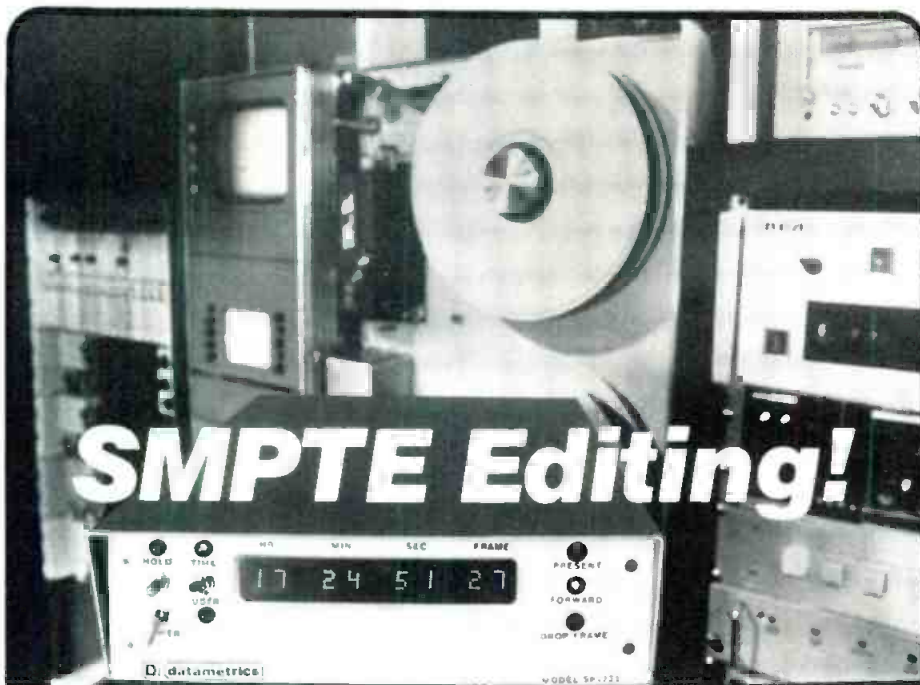

SMPTE Editing!

- Datametrics Compact SP733 Reads Time/User Information Over All Input Ranges.
- Manual Use Based on Display and/or Video Inserter.
- Automatic Use Based on Logic Compatible Outputs.



datametrics

Datametrics, Inc.
340 Fordham Road, Wilmington, Mass. 01887
Tel: (617) 658-5410 TWX 710-347-7672

Circle 199 on Reader Service Card

Dependable



The P-50, we improved it to make it more dependable than ever. No other TV camera pedestal can come close to the P-50 in reliability and versatility (height: 21" min./57" max.; load capacity: 350 lbs.). With 20 years of experience in building quality camera pedestals, we bring you the P-50 at a more affordable price than its competitors. The P-50, you can depend on it.

TeleVision Products Co.

9016 AVIATION BLVD.
INGLEWOOD, CA 90301
(213) 776-3276

Circle 200 on Reader Service Card

The Source '79

VITAL INDUSTRIES INC
3700 NE 53rd Ave Gainesville FL 32601
904 378-1581

Audio dist amps; video processing amps: pulse, dist & subcarrier amps; SEGs; digital video effects devices & subcarrier amps; large, small & auto production switchers; automated master control systems; post production switchers; routing switchers; frame synchronizers VS

W

WANG VOICE COMM INC

Executive Dr Hudson NH 03051
603 889-8564

Digital audio systems for production & operation
See ad pg 10

WARD BECK SYSTEMS LTD

841 Progress Ave Scarborough ONT M1H 2X4
416 438-6550

Audio consoles (TV & radio); TV intercom systems; audio dist & switching systems; related audio components VS

See ad cover 4

AZ WBS Inc 6900 E Camelback Rd Suite 1010
Scottsdale 85251

WATERS MANUFACTURING INC

Longfellow Center Wayland MA 01778
617 358-2777

Audio attenuators & controls, rotary & slide

WAVETEK INDIANA INC

66 N First Ave Beech Grove IN 46107
317 783-3221

Sweep signal generators, RF detectors; function, signal, sweep generators; oscilloscopes; phase meters; transmission level test set; programmable waveform synthesizers; test accessories

VS MEANS IT'S VERIFIED

WESTLAKE AUDIO

6311 Wilshire Blvd Los Angeles, CA 90048
213 655-0303

Tape splicing block & cleaner; speakers, cabinets, furniture, acoustic materials, complete studio construction

WESTINGHOUSE ELECTRIC CORP/IND & GOVT TUBE DIV

Westinghouse Circle Horseheads NY 14845
607 796-3211

RF & vacuum tubes; rectifiers; low light level surveillance cameras VS

WESTON INSTRUMENTS DIV OF SANGAMO-WESTON INC

614 Frelinghuysen Ave Newark NJ 07114
201 242-2600

Analog VU meters, voltmeters, multimeters, dB meters

WHIRLWIND MUSIC & AUDIO INC

100 Boxart St Rochester NY 14612
716 663-8820

Cabinets; connectors; wire & cable; mobile van construction; RF cables; complete studio construction

WHITE INSTRUMENTS INC

PO Box 698 Austin TX 78767
512 892-0752

Equalizers & filters (passive & active); real time spectrum analyzers; audio generators VS

WIDE BAND ENGINEERING CO INC

PO Box 21652 Phoenix AZ 85036
602 254-1570

RF amps; comparator; impedance bridges; directional couplers; power dividers; patch panels; RF filters, detectors, switches; terminations; impedance transformers VS

continued on page 156

THE MICROWAVE RADIO FOR EVERY USE

The Only Microwave Radio of its Kind.

Frequency Agility

The TCM-6 is tunable across each band from 1.7 to 15.35 GHz. Change bands by plug-in RF module replacement.

Fixed Link or Portable

Simplex, duplex and diversity operation in tripod, tower or rack mount configuration.

Proven Operation

Used worldwide from arctic to desert environments by major television and telecommunications administrations.

Full Performance

Color video with FM or digital subcarrier channels. 1800 FDM voice channels. 34 Mb/s digital data or wideband radar video.

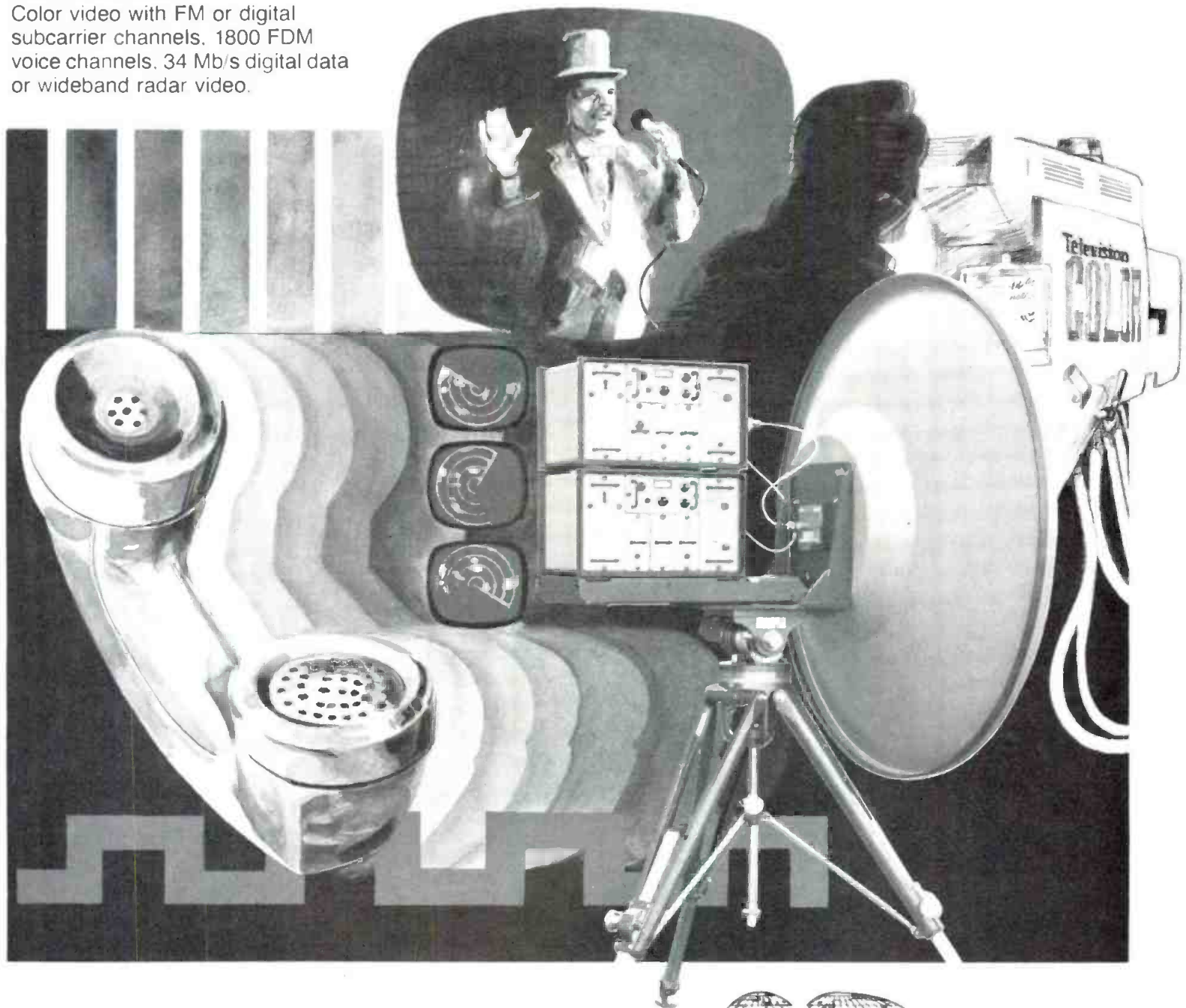

Loral Corporation

9020 Balboa Avenue San Diego, CA 92123 U.S.A

Phone: (714) 278-4100 TWX: TERRACOM SDG 910-335-1202

Circle 198 on Reader Service Card

www.americanradiohistory.com

Go anywhere SMPTE Edit Code Generator and Companion Reader that will give you an instant shot list.



The only portable SMPTE Code Generator. Shintron Model 640 SMPTE Edit Code Generator.

- Goes anywhere with your ENG crew.
- Light and rugged. It attaches to your VTR and produces accurate edit code as you shoot important scenes.
- You cannot enjoy full advantages of ENG unless you have the 640 SMPTE Edit Code Generator.
- EBU European Standard version available.



Model 644 Edit Code Reader

When Shintron builds a new product, we think of our customers' convenience first. Good Edit Code Readers are a dime a dozen today, but which one can generate an instant shot list? The only one is Model 644 Edit Code Reader / Raster Display and Shot List printer.

SHINTRON

Worldwide

Cambridge, MA 02142 USA
(617) 491-8700 / telex: 921497

Circle 202 on Reader Service Card

The Source '79

WIDE RANGE ELECTRONICS CORP
2119 Schuetz Rd St Louis MO 63141
314 567-5366

Head degaussers; bulk erasers; magnetic recording equip & accessories; optical sound recorders, systems & components

WILKINSON ELECTRONICS INC
PO Box 738 Trainer PA 19013
215 497-5100

AM & FM broadcast transmitters; audio consoles; audio compressor/limiters; distribution amps, equalizers, line amps; demodulators, exciters, RF amps; modulation & frequency monitors; AC line surge protectors; rectifier stacks

THE WILL-BURT CO TMD DIV
169 S Main St Orville OH 44667
216 682-7015

Telescoping masts VS

WINEGARD CO
3000 Kirkwood St Burlington IA 52601
319 753-0121

Over the air pay TV equip

WINSTED CORP
8127 Pleasant Ave S Minneapolis MN 55420
612 888-1957

Racks, cabinets, shipping cases, storage trucks, consoles, tape storage VS

See ad pg 192

WOLF COACH INC
200 Bartlett St Northboro MA 01532
617 393-2551

Mobile van construction VS

WORLD VIDEO INC
PO Box 117 Boyertown PA 19512
215 367-6055

Color & AC/DC color portable monitors; intercom systems; waveform monitors & analyzers

Y

YAMAHA INTERNAT'L CORP COMBO PRODUCTS DIVISION
6600 Orangethorpe Ave Buena Park CA 90620
714 522-9383

Monitor, power, PA audio amps; active equalizers & filters; special effects; delay lines; integrated mixer/amp; mono, stereo, quad, audio for TV, portable, SR mixing consoles; turntables; headphones; music synthesizers; speakers; tape & cassette player/recorder; cabinets VS

See ad pg 103

YARDNEY ELECTRIC CORP
82 Mechanic St Pawcatuck CT 02891
203 599-1100

Silver, zinc & cadmium batteries; high intensity lights VS

See ad pg 116

Z

ZEI-MARK CORP
PO Box 182 Brookfield Center CT 06805
203 355-0008

Optical multiplexer; telecine film chain with preview; film chain adapters for 16mm & super-8mm film projectors, lap dissolve slide projector, telecine accessories VS

ZOOMAR INC
55 Sea Cliff Ave Glen Cove NY 11542
516 676-1900

Optics; optical instruments VS

VS MEANS IT'S VERIFIED



when you've got it, FLAUNT IT!

And QEI's got it...the line of broadcast equipment that the industry is looking at...and buying.

**FM ATS
AM ATS**
AM, FM and FM Stereo Modulation Monitors
Stereo and SCA Generators
AM and FM RF Amplifiers
FM Exciters for both replacement and OEM

It's all here...competitively priced with on time delivery and complete back up by QEI trained technicians.

For additional information contact:
CORPORATION
Route 73 Kresson, NJ 08053 (609) 767-8052

Quality-Excellence-Integrity

Circle 203 on Reader Service Card

What's your angle of view?

Attention: Cameramen,
Directors, Engineers.



Varotal MRL is a multi-role lens. It is designed to give you all the shots you need, inside studio or out, with standard or EFP cameras. It's the world's smallest and lightest production TV zoom lens, yet delivers a range of angles 52°-1°.

Most important MRL lens specifications are studio quality. There's no need to compromise sharpness, focus or contrast for weight and utility. With MRL you can expect, and get, production quality that is deserving of your credit line.

Discover the flexibility, versatility, and economy – the quick change artistry – of Varotal by Taylor-Hobson.

TAYLOR-HOBSON

MRL has snap-on front units – one for studio, one for outside, and one for all-around use; and, there's no need to re-register or re-set the back focus when you change lenses.

Send for 12-page Bulletin MRL.



RANK PRECISION
INDUSTRIES, INC.

260 North Route 303 West Nyack, NY 10994 (914) 358-4450

WGBH engineers talk about the Ikegami HK-312



WGBH covers Boston Pops Orchestra concerts
with Ikegami HK-312 cameras from Symphony
Hall, Boston.

Eight Ikegami HK-312 studio color cameras are in service at WGBH, Boston, some dating back to October 1977 — long enough for intelligence on their performance. From recent interviews with key WGBH people, read these excerpts.

Pops without noise

Tom Keller, Director of Engineering:

“The HK-312s have such high sensitivity that we were able to reduce significantly our light levels at the Boston Pops and Symphony telecasts. Yet, despite the major light reduction, we experienced no visible noise with the HK-312s . . . With their remarkable reliability record, we can depend on 6 cameras for 6-camera coverage, and not 7 for 6 as in the past. After all, you can't stop a live orchestra performance for a retake if you've lost a camera.”

2 IRE, but a complaint

Ken Hori, Senior Engineer for Advanced Development:

“We tested several camera makes for RFI within a quarter-mile of a 50 KW radio transmitter. The HK-312 measured 2 IRE, whereas most others were in the 5 to 7 IRE area, and some as high as 20 IRE . . . For symphony remotes we'd need 2 to 5 hours for warm-up, but nowadays we're set up in less than an hour . . . We like its straightforward design — example, its truly high signal-to-noise ratio as compared to other cameras that resort to reduced bandwidth to attain a comparable ratio but wind up delivering noise too . . .”

We did get one complaint from the maintenance crew. They said that because they rarely found the problem of a down HK-312, they would never get to know the HK-312 well enough to fix it.

Washouts and dropouts

*Bill Fairweather,
Video Control Engineer:*

“During a lighting seminar staged here by Imero Fiorentino Associates, an actor in a normally lighted scene held up a sheet of white paper with printing on

it to show loss of detail in the case of more than 60 percent tv white reflectance. The HK-312, however, was able to retain enough detail for the printing to be readable on the monitor.

Next came a demonstration of the dangers of too much or too little light on a chroma-key background. The HK-312 held the key to such a low light level on the blank background that the lecturer grinned and said, “I guess WGBH has pretty good cameras!” and went on to the next subject.”

The HK-312 is the camera that met WGBH criteria for performance, stability, and reliability. They also have HL-53s, high-performance portable cameras that interface with HK-312 CCUs and can operate portably with their own CCUs.

Adapters for triax cable, using digital techniques, make their cameras remote-usable at nearly a mile from base stations, yet easily revertible to multi-core cable whenever needed.

In daily use, their HK-312s and HL-53s are interfaced with microprocessor-computer control units that automatically cycle them through all set-up adjustments, including black-and-white balance, flare and gamma correction, video gain, and eight registration functions, then recheck all those adjustments — all within 45 seconds. The cameras can also operate independently of the set-up computers, a feature that is an Ikegami exclusive.

If all of this suggests that the HK-312 is probably the best studio/field color camera in the industry, consider this: camera, set-up computer, and triax adaptor are not only operational, they are deliverable. For details or a demonstration, contact **Ikegami Electronics (USA) Inc.**, 37 Brook Ave., Maywood, NJ 07607, (201) 368-9171 / West Coast: 19164 Van Ness Ave., Torrance, CA 90501, (213) 328-2814 / Southwest: 330 North Belt East, Houston TX 77060, (713) 445-0100.

Ikegami HK-312

Eight good reasons to be a Beyer Buyer.

one The first reason is Beyer. We have fifty years experience making the world's finest microphones and headphones. And an unmatched reputation for quality, reliability and innovation. The choice of professionals everywhere.

two M 160. One of the world's best-loved and most versatile microphones. Warm, soft sound favored by vocalists and musicians alike. Dual ribbon design for high strength and fast transient response.



three Beyer headphones. A full range of high quality professional models for critical monitoring and reliable communication. DT 109 combines stereo headphones and boom-mounted microphone, ideal for on-air use and disco deejays. DT 444S wireless headphone receives sound from an infra-red LED transmitter up to



300 feet away. Full 20-20,000Hz frequency response. Six hour stereo operation on rechargeable NiCad batteries.

four The new M 400. A great performer's mic. Supercardioid pick-up pattern to minimize feedback. Rugged design for long life. Tapered frequency response with rising high end and rolled off lows, plus midrange presence boost. Built-in humbucking coil and pop filter. Dynamic design is unaffected by heat and humidity.

We're looking for a few more great dealers to handle the Beyer line. Contact Norm Wieland at Burns Audiotechnics.



five Beyer microphone stands and booms. A full range of mic mounts for floor and desk use, with fixed and folding bases. Available with collapsible tubes for easy packing. Also heavy-duty stands for speaker cabinets. **six** Beyer microphone accessories. Wind screens, impedance matching transformers, in-line switches, power supplies, wireless transmitters, stereo arms, goosenecks, clamps, thread adapters, anti-shock suspensions, and even a mic stand ashtray! The whole works. If you can use it with a mic, we make it.



seven M 713. One of our unsurpassed studio condenser mics. Modular system; accepts different transducer capsules and power supplies. Gold-vapored mylar diaphragm for high transient response. Mu-metal shield. Temperature and humidity stable.

eight See your dealer or write for information on our product line. You'll have many more reasons to be a Beyer buyer.

Beyer
Dynamic

BURNS AUDIOTRONICS, INC.
5-05 Burns Avenue, Hicksville, NY 11801
(516) 935-8000

Circle 206 on Reader Service Card

INDEPENDENT BROADCAST REPS/DISTRIBUTORS

**Including cross reference to companies
whose products are advertised**

Information regarding the representatives and distributors listed in this section was supplied by the manufacturers listed in the preceding section. Some others are listed by virtue of their reputations within the localities they do business. This section may be most effectively used if the following points are kept in mind: 1) The product line attributed to each representative is very general. In most cases these reps/distributors carry the products of a number of manufacturers and may carry a broader range of products than the "line" may imply. 2) The advertiser's name which appears below the listing can be used as a guide to the dealer handling the specific product sought, and as a guide to more information on the product(s) referred to in the advertisement. 3) If no local dealer can be found, a call to the manufacturer of the product sought may be the quickest way to identify a local supplier.

ALABAMA

BCS ASSOCS

3322 S Memorial Pkwy
Huntsville 35807
205 881-6220
Line: full line video equip

CALHOUN CO INC

PO Box 76055
Birmingham 35223
205 942-7620
Line: full line video equip,
lighting equip

GRACE A-V SYSTEMS

240 Oxmoor Circle Ste 102
Birmingham 35209
Line: full line audio & visual equip

CHEROKEE SUPPLY

103 Bibb St
Alexander 35010
Line: RF and audio components

GRAY COMMUNICATIONS

209 Oxmoor Circle
Birmingham 35209
205 942-2824
4367 Downtowner Loop N
Mobile 36609
205 343-0662
Line: full line broadcast equip
ISI see ad pgs 52, 97, 180
Microtime see ad pg 66

GULF COAST ELECTRONICS

2613 Cameron St
Mobile 36607
205 476-7690
Line: full line TV

MATEC INC

PO Box 6968
514 Alton Rd
Birmingham 35210
205 956-2200
Line: audio equip
Conrac see ad pg 39

LEE ASSOC MID-SOUTH INC

817 Wheeler Ave
Huntsville 35801
205 533-5896
Line: full line audio & video equip
Marconi see ad pgs 93,63

JAMES L HIGHSMITH CO

3322 S Memorial Pkwy
Huntsville 35801
205 881-3294
Line: full line broadcast equip

SPHERE AUDIO SALES

3422 Hurricane Rd
Birmingham 35226
205 979-3561
Line: full line audio equip
BTX see ad pg 182

SIGNAL ENGINEERING & SALES

720 S. 23rd St
Birmingham 35202
205 328-6431

Line: video equip
CEI see ad pg 105
NEC see ad pg 86-87

UNITED ASSOC

823 City Federal Bldg
Birmingham 35203
205 252-3079
Line: video & lighting equip

ALASKA

NORTHERN VIDEO SYSTEMS INC

Business Park Blvd
Anchorage 99503
907 279-5571
Line: full line audio & video equip,
lighting equip
Microtime see ad pg 66

HARRY J LANG & ASSOCS

1406 W 47th Ave
Anchorage 99503
907 279-5741
Line: audio & video equip

ARIZONA

AMERICAN ELECTRONICS

313 S 36 St
Phoenix 85043
602 275-5496
Line: audio & video equip

BARNHILL THREE INC

7319 E Stetson Dr
Scottsdale 85251
602 947-7841
Line: full line test equip

BETA-SIGMA CORP

2711 E Indian School Rd
Phoenix 85016
602 955-1075
Line: video equip
ISI see ad pgs 52, 97, 180

FISHER-BURKE

120 E Willetta St
Phoenix 85004
602 257-0225
Line: audio equip

H P MARKETING

917 W Heatherbrae
Phoenix 85013
602-279-4883
Line: broadcasting equip
Orange County see ad pg 176

INTERNATIONAL MARKETING ASSOC

1220 W Alameda Ste 109
Tempe 85282
602 894-1318
Line: audio equip

LARRY McMILLAN

5607 E Horseshoe Rd
Paradise Valley 85251
602 991-1077
Line: audio/video components

MEASUREMENT CONSULTANTS

PO Box 966
Scottsdale 85252
602 994-9519
Line: test instruments
Marconi see ad pgs 93, 63

OMNITRONICS INC

711 Indian School Rd
Phoenix 85016
602 956-6803
Line: audio equip

RIA CORP

PO Box 1678
Cottonwood 86326
Line: microwave, audio & CATV equip
Echo Science see ad pgs 64-65

ROH'S INC

4553 E Broadway
Tucson 85711
602 795-8573
Line: full line video equip, CCTV systems
Microtime see ad pg 66
Conrac see ad pg 39

VIDCOM

1908 E McDowell
Phoenix 85006
602 253-2103
Line: video; lighting equip

ZEUS INC

546 E Portland
Phoenix 85004
602 253-6104
Line: audio & video equip

ZONAR CORP

2922 W Weldon
Phoenix 85617
602 264-2100
Line: full line audio & video equip

ARKANSAS

CUSTOM PRODUCTS

PO Box 247
Magnolia 71753
501 234-3778
Line: audio/video components & equip
Russco see ad pg 181

PAUL JAMESON

PO Box 247
Magnolia 71753
501 234-3778
Line: attenuators

STANLEY COMMUNICATIONS

3600 W 69th St
Little Rock 72209
501 562-9200
Line: full lines broadcast equip
ISI see ad pgs 52, 97, 180

TECHNICAL INDUSTRIES

3520 W 69th St Suite 306
Little Rock 72209
501 568-2294
Line: full line video equip

MACH ONE.

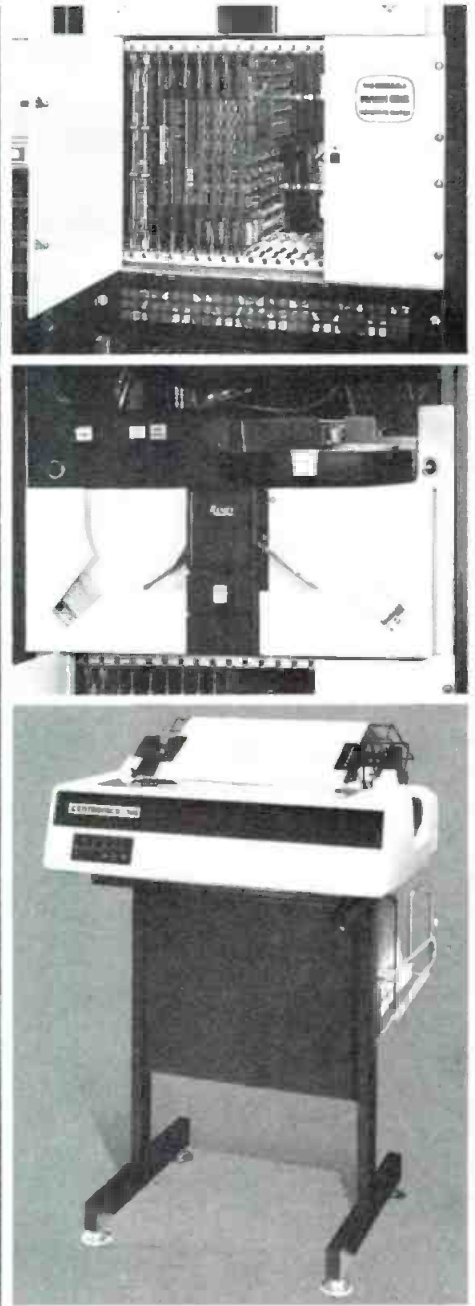

The Editing System for All Reasons.

MACH ONE takes you a step beyond any other computerized video tape editing system now available.

MACH ONE is more versatile, faster and gives you greater list management capabilities.

MACH ONE's dedicated keyboard is editor-oriented and offers one-button commands that eliminate non-essential computer communication which cuts into your editing time.

MACH ONE can be used on-line or off-line with 2" quad, 1" helical or 3/4" cassette recorders.

MACH ONE is the only editing system capable of switching between and editing 24-, 25- and 30-frame-per-second formats.

MACH ONE provides a total range of

editing freedom with full effects generation and automatic assembly operation.

MACH ONE's space-saving, single-rack electronics are instantly expandable to upgrade your system from a simple, two-VTR, cuts only to a fully-equipped, six-VTR operation.

MACH ONE includes a one-year package of software updates.

To find out for yourself all the reasons why **MACH ONE** is the final solution to fast, accurate and efficient video editing, write or call TeleMation Division, P.O. Box 15068, Salt Lake City, Utah 85115 (801) 972-8000

TELEMATION DIVISION



BELL & HOWELL

(c) 1979 Bell & Howell Company. All Rights reserved. TeleMation and Bell & Howell are trademarks of Bell & Howell Company.

Reps/Dists

California continued

OLSEN

1535 Ivar Ave
Hollywood 90028
213 461-4631
Line: lighting equip

OMEGA ASSOC

14326 Isis Ave
Lawndale 90260
213 679-9021
Line: full line video equip,
lighting equip
CEI see ad pg 105
Conrac see ad pg 39
Microtime see ad pg 66

OMEGA INDUST

841 Production Pl
Newport Beach 92663
714 642-0746
Line: broadcast equip
Rank Precision see ad pg 157

PACIFIC RECORDERS & ENG CORP

11100 Roselle St
San Diego 92121
714 453-3255
Line: full line audio equip accessories
ADR see ad pg 179

PACIFIC VIDEO PRODUCTS

2600 E Katella
Anaheim 92806
714 634-8585
ISI see ad pgs 52, 97, 180

PERSPECTIVE MEASUREMENT

8369 Vickers St Ste D
San Diego 92111
714-278-8931
Line: video equipment
CEI see ad pg 105
Cohu see ad pg 178

PROGRESSIVE MARKETING INC

75 Mt Hermon Rd
Scotts Valley 95060
408 438-1097
Line: video, transmitting &
measuring equip

RDC NORTH

3530 Melody Dr
Walnut Creek 94595
Line: video equip
Echo Science see ad pgs 64-65

RICHARD REILLY

150 Old Adobe Way
Los Gatos 95030
408 866-9486
Line: full line audio & video equip

ROBERT RICCI

1571 Parkway Rd
Tustin 92680
714 731-3011
Line: full line audio & video equip

RIGGINS ELECTRONIC SALES

3272 E Willow St
Long Beach 90806
213 598-7007
Line: video equip
UMC see ad pg 14

ROLLS ELECTRONICS

4260 Lankerskim Blvd
N Hollywood 91602
213 877-4424
Line: audio equip

ROSS COMM

PO Box 5003
Covian 91723
213 919-3446

Line: broadcast equip
Alexander see ad pg 104

RUSSCO ELECTRONICS MFG

1707 Brookhaven Dr
Clovis 93612
209 291-5591
Line: audio equip

BETTY SCHNEIDER

5432 W 102 St
Los Angeles 90045
213 776-4600
Line: full line lighting equip

SHIMIC INC/SHINDENSHI MFG CO

2041 Rosecrans
El Segundo 90245
213 640-1098
Line: broadcasting equip
Orange County see ad pg 176

SIERRA AUDIO

621 S Glenwood Pl
Burbank 91506
213 843-8115
Line: audio equip
Orange County see ad pg 176

SIERRA MARKETING INC

470 Aldo Ave
Santa Clara 95050
408 988-2833
Line: audio equip

DON SIMON

Ross 336 Hillcrest
El Segundo 90245
213 322-7114
Line: broadcasting equip
Alexander see ad pg 104

R E SNADER & ASSOC

216 E Strawberry Dr
Mill Valley 94941
415 383-4263
Line: video & lighting equip
ISI see ad pgs 52, 97, 180

SOUND DYNAMICS INC

PO Box 32055
San Jose 95152
408 926-3588
Line: audio components

SOUND DYNAMICS, INC

PO Box 32056
San Jose 95152
408 926-3588
Line audio components
ESE see ad pg 196

SOUND GENESIS INC

445 Bryant St
San Francisco 94107
415 391-8776
Line: audio equip
Inovonics see ad pg 116
Orange County see ad pg 176
UMC see ad pg 14

SPECTRUM ASSOCIATES, INC

1823 E 17th St
Santa Ana 92711
213 323-0603
Line: audio components

LL STOAKES INC

4438 Ingraham St
San Diego 92109
Line: video equip
Echo Science see ad pgs 64-65

STUDIO MAINTENANCE SERVICE INC

12438 Magnolia Boulevard
North Hollywood 91607
213 877-3311
Line: broadcasting equip
Orange County see ad pg 176

SYSCOM

880 Maude Ave
Mountain View 94043
415 967-8229
Line: full line audio & video equip

SYSTEM ASSOC

6117 Reseda Blvd Ste 205
Reseda 91335
Line: full line audio & video equip
Utah Scientific see ad pg 60

TABER MFG & ENGINEERING

2081 Edison Ave
San Leandro 94577
415 635-3831
Line: audio equip
Inovonics see ad pg 116

TELAUDIO CENTER

PO Box 921
Beverly Hills 90213
213 276-2726
Line: full line video equip
Microtime see ad pg 66

TELEVISION ASSOCIATES

2410 Charleston Rd
Mountain View 94043
415 967-6040
Line: full line video & audio equip

TOTAL VIDEO SERVICE

405 Chester Ave
Bakersfield 93301
805 324-7239
Line: video equip

BRIAN TRANKLE & ASSOC

820 Black Mountain Rd
Hillsborough 94010
415 344-1133
Line: audio equip & components
UREI see ad pg 107

TRI TRONICS INC

2921 W Alameda Ave
Burbank 91505
213 843-2170
Line: full line video equip
Conrac see ad pg 39
Ikegami see ad pgs 53, 158-159

UNITED MEDIA INC

1571 Parkway Loop Unit D
Tustin 92608
714 431-3011
150 Old Adobe Way
Los Gatos 95030
408 736-3600
Line: full line video equip

VIDEO EQUIPMENT CORP

7377 Convoy Ct
San Diego 92111
714 278-4274
Line: audio & video equip,
lighting equip
Asaca see ad pg 19
CEI see ad pg 105
Digital Video Systems see ad Cover 3
ISI see ad pgs 52, 97, 180
UMC see ad pg 14
Echo Sciences see ad pgs 64-65

VIDEO LOGIC SERVICES INTL

PO Box 1434
Los Gatos 95030
408 356-1031
Line: full line video equip

VIDEO MEDIA

250 N Wolfe Rd
Sunnyvale 94086
408 733-6500
Line: video & lighting equip
Digital Video Systems see ad Cover 3

VIDEO SYSTEMS INC

12530 Beatrice St
Los Angeles 90066
213 871-0677
Line: full line video equip,
lighting equip
Asaca see ad pg 19
Digital Video Systems see ad Cover 3
Echo Sciences see ad pgs 64-65

VIF INTL

1151 Viscaino Ave
Sunnyvale 94086
408 739-9740

Line: full line audio & video equip
Inovonics see ad pg 116

WARSCO

4311 S Figueroa St
Los Angeles 90037
213-233-8171
Line: full line video equip

WESTERN AV SYSTEMS

122 Cajon St
Redlands 92373
714 793-2905
Line: video equip

WESTLAKE AUDIO

6311 Wilshire Blvd
Los Angeles 90048
213 655-0303
Line: full line audio equip
ADR see ad pg 179
Inovonics see ad pg 116
Orange County see ad pg 176
UMC see ad pg 14

COLORADO

ARTCOM

PO Box 176
Arvada 80001
303 979-3225
Line: audio equip

AUDIOTOLLS CORP

5250 N Broadway
Denver 80216
303 534-5683
Line: broadcast equip
Orange County see ad pg 176

AUDIO-VIDEO SYSTEMS INC

Rbt Pechar
3390 Peoria Ste 306
Aurora 80010
303 341-9994
Line: audio & video equip
ISI see ad pgs 52, 97, 180

AURORA MARKETING

6 Prker Pl Suite 265
Aurora 80014
Line: Broadcast equip
Alexander see ad pg 104

B&B ELECTRONIC PRODUCTS INC

500 Quebec S
Denver 80237
303 773-6700
Line: audio equip
Otari see ad pgs 149, 151, 153

BARNHILL THREE INC

1980 S Quebec St Unit 4
Denver 80231
303 750-1222
Line: full line audio & video equip

CEAVCO AUDIO VISUAL

1650 Webster St
Denver 80215
303 238-6493
Line: video equip
Microtime see ad pg 66

CEC

1602 S Parker Rd Ste 102
Denver 80231
202 751-3252
Line: full line audio & video equip
Marconi see ad pgs 63, 93

CENTENNIAL ENTERPRISES

711 Vallejo St
Denver 80204
303 534-2228
Line: video equip

DAVIS AUDIO-VISUAL INC

1801 Federal Blvd
Denver 80204
303 455-1122
Line: video & lighting equip
Conrac see ad pg 39
Microtime see ad pg 66

continued on page 166

We interrupt this magazine

to bring you all you need in broadcast equipment.

One call is all it takes to get anything and everything you need in broadcast equipment — from turntables to AM and FM transmitters.

Choose from Rockwell-Collins equipment plus that of close to a hundred different manufacturers. It's one-stop shopping with fourfold advantages.

1. Quality products. Our transmitters and consoles are the result of our technical excellence and single-minded dedication exclusively to the radio broadcaster for over 40 years. We've never once deviated from our goal: to make our name synonymous with quality, reliability and long life... for your benefit.

2. Broad choice of products. In addition to our own Generation 4TM FM transmitters and our all-new Power Rock 5-kW AM transmitters (the cleanest,

brightest, loudest AM in town), we carry products from the largest team of respected specialty vendors available anywhere from a single source — from ADC to UREI, with nearly a hundred other such leaders in between. If we don't have what you want, chances are we can get it for you. Fast.

3. Flexible financing arrangements. If it's under \$1000, you can use your own or your company's Master Charge. For larger orders, take your choice of time-purchase (up to 5 years) or lease plans.

4. Unbeatable customer support. Your emergency is our emergency. We're ready to respond — without delay — 24 hours a day, 365 days a year.

See the cities listed below for the representative nearest you — and call him for one-stop shopping, Rockwell-Collins style. Ask him for a copy of our new brochure, or contact: Collins Broadcast Marketing, Dept. 406-106, Electronics Operations, Rockwell International, Dallas, Texas 75207. Phone: 214/996-5424.



**Rockwell
International**

...where science gets down to business

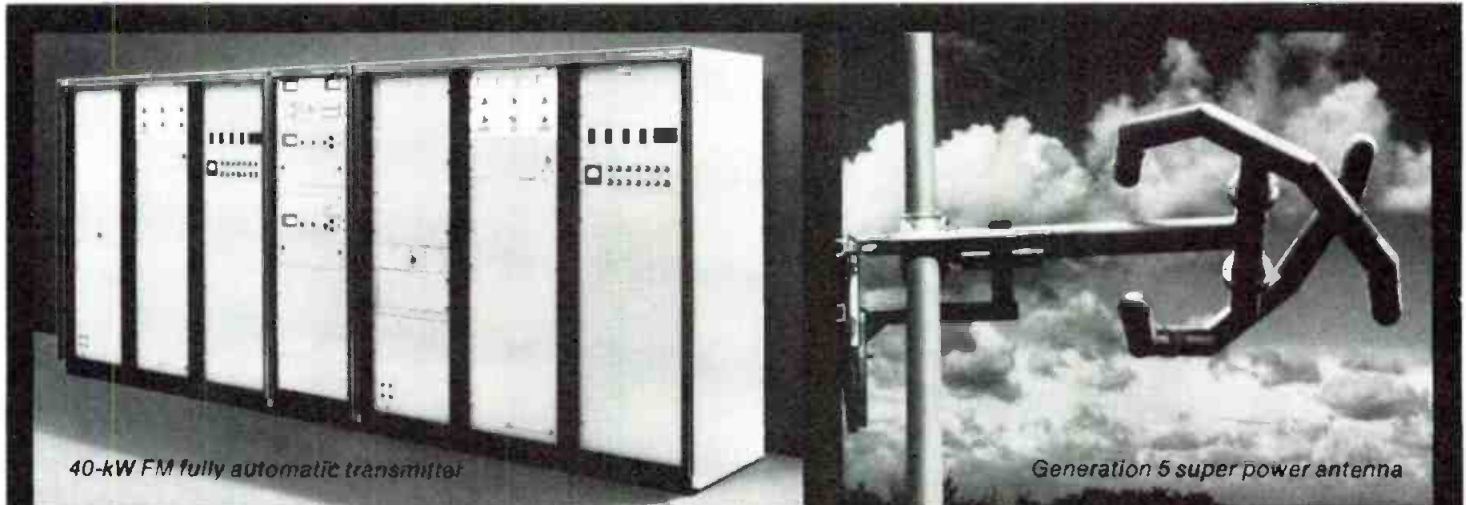

40-kW FM fully automatic transmitter

Generation 5 super power antenna

The latest words in communications: Rockwell-Collins.

Brussels 242-4048 • Cairo 894531 • Frankfurt (0) 6106-4093 • Hong Kong 5-274-321 • Kuala Lumpur 27283 • London 01-759-9911 • Manila 892-742 • Mexico City (905) 533-1846
Melbourne (Lilydale) (03) 726-0766 • Paris (Rungis Cedex) 687-31-02 • Rio de Janeiro (021) 246-3276 • Riyadh 69060 • Rome (0) 6-862-415 • Seoul 74-9276 • Tehran 685-180
Tokyo 478-1278 or 478-1279 • Toronto (416) 757-1101 • Jeddah 54600

Circle 208 on Reader Service Card

www.americanradiohistory.com

Reps/Dists

Colorado continued

DIDIER/DENVER INC

4665 Kipling
Wheat Ridge 80033
622-6666
Line: full line broadcast equip
ADDA Corp. see ad pgs 23, 101
Asaca see ad pg 19
TFT see ad pg 75

GENERAL SOUND & ELECTRONICS

1369A W Byers Pl
Denver 80223
303 722-1861
Line: audio & video equip

HIGHLAND ASSOC

80 Garden Office Ctr
1380 W Midway Blvd
Broomfield 80020
303 854-2003
Line: full line audio & video equip

HP MARKETING

2530 W Church Ave
Littleton 80120
303 794-8367
Line: audio & test equip
Orange County see ad pg 176
UREI see ad pg 107

INTER-MOUNTAIN VIDEO SYSTEM

2635 S Sante Fe Dr
Denver 80223
303 744-2724
Line: video & lighting equip

INVERNESS MARKETING INC DIV OF CLIFF-JOHN ELECTRONICS INC

Bldg 1-Suite 1
14 Inverness Dr East
Englewood 80110
303 770-2300
Line: audio components

MCCLOUD & RAYMOND CO

1562 S Parker Rd
Denver 80231
303 757-5305

Line: audio equip
Telex see ad pg 123

MILE HIGH MARKETING

1813 E 98th Pl
Thornton 80229
303 457-2058
Line: video equip
Knox see ad pg 35

PAR ASSOC

7305 Spring Ct
Boulder 80303
303 499-4736
Line: test instruments
Marconi see ad pgs 63, 93

RIA CORPORATION

Box 56
430 Garland St
Brighton
303 238-2593
Line: TV broadcast equip
Echo Science see ad pgs 64-65

SCIENTIFIC INSTRUMENTS

5765 Logan Suite 206
Denver 80216

303 623-6447
Line: video equip
Cohu see ad pg 178

MIKE SHAFER

PO Box 2537
Grand Junction 81501
303 243-5373
Line: broadcast equip
Cetec see ad pgs 31, 173

VIDEO SERVICES

1805 S Bellaire St #100
Denver 80222
303 753-0887
Line: full line video equip

CONNECTICUT

JOHN B ANTHONY

922 High Ridge Rd
Stamford 06903
203 322-9202
Line: full line audio equipment
Otari see ad pgs 149, 151, 153
UREI see ad pg 107

AUDIO/TECHNIQUES INC

652 Glenbrook Rd
Stamford 06906
203 359-2313
Line: full line audio equip, recording accessories Imported and domestic
ADR see ad pg 179

BURNS ELECTRONIC SECURITY INC

735 Route 5
S Windsor 06074
203 528-2186
Line: full line audio & video equip

CONCORD COMMUNICATIONS DIV

Auvitel Systems Corp
76 Main St Box 825
Norwalk 06852
203 846-9575
Line: video & audio equip

Production and Transmission Equipment

DIDIER/DENVER

WHEAT RIDGE, COLORADO

TV • AM • FM

THE STATE OF OUR ART

- New "series II" improved headsets
- 50 station capability with up to 8 channels using SB8 switchboard monitor
- External program feed with volume control
- Wide frequency response (200Hz to 12kHz) for exceptional intelligibility
- Designed for high noise environments
- Visual signalling uses bright amber lights
- Adjustable sidetone reduces feedback and background noise

Cedar Grove Sound
Richmond, B.C.
(604) 273-1851

La Salle Audio
Montreal, Quebec
(514) 342-4503

- Mic on-off feature standard with headset and remote stations
- Single and two channel systems virtually immune to RF and SCR dimmer noise
- Remote stations available in portable, wall mount and rack mount versions including speakers for paging and monitoring
- Catalogue with complete specifications available upon request

 **Clear-Com**
intercom systems

759 Harrison Street
San Francisco, CA 94107
(415) 989-1130



DENSON ELECTRONICS CORP
 Longview St
 Rockville 06066
 603 434-0731
 Line: video equip

H&B SYSTEMS
 21 Audio Ln
 New Haven 06519
 203 777-5301
 Line: video & lighting equip
 Microtime see ad pg 66

ROBERT HENSON
 1 Elmwood Lane
 Westport 06880
 203 226-4482
 Line: full line video equip

IRI SALES GROUP
 124 Hebron Ave
 Glastonbury 06033
 203 633-0777
 Line: test & monitoring instruments

KEMP COMMUNICATIONS
 150 Lost Acres Rd
 N Granby 06060
 203 653-2519
 Line: audio & telco equip

NATIONAL VIDEO SERVICES
 3 Pembroke Rd
 Danbury 06810
 203 792-3862
 Line: video equip
 CEI see ad pg 105
 Microtime see ad pg 66

NBS ASSOCIATES
 Main St
 New Preston 06777
 203 868-0501
 Line: audio components
 Tech Labs see ad pg 205

NESA CORP
 12 Silvermine Road

Brookfield Center 06805
 203 775-0578
 Line: broadcast equip
 Alexander see ad pg 104

SCIENTIFIC DEVICES
 3074 Whitney Ave
 Mt Carmel 06518
 203 248-9361
 Line: audio & video equip

VIDEOPLAY INDUSTRIES
 Tolland Industrial Park
 Rte 30 Box 800
 Rockville 06066
 203 872-9195
 Line: video equip
 Microtime see ad pg 66

DISTRICT OF COLUMBIA

BRENNER CINE-SOUND
 5215 Wisconsin Ave NW
 Washington 20015
 202 344-3800
 Line: sound & lighting equip

COMREX CORP
 PO Box 17011
 Dulles Intl Airport
 Washington 20041
 703 471-4215
 Line: full line video equip
 Ramko see ad pgs 46-47

PROFESSIONAL PRODUCTS INC
 4964 Fairmont Ave
 Bethesda 20014
 301 933-3451
 Line: full line video equip

VARK AUDIO
 1028 3rd St NW
 Washington DC 20007
 202 333-4361
 Line: audio equip
 Inovonics see ad pg 116

FLORIDA

ALEXANDER BATTERY
 Box 1053
 Pompano 33062
 305 781-1181
 Line: broadcast equip
 Alexander see ad pg 104

BCS ASSOC INC
 940 N Fern Creek Ave
 Orlando 32803
 305 896-4881
 Line: measuring equip, monitors,
 audio & video equip

BENCNIK ASSOC
 1311 NE 13th Ave
 Ocala 39670
 Line: audio equip
 Modular Audio see ad pg 187

**BROADCAST AUTOMATION
 ASSOC INTL**
 PO Box 5882
 Ft Lauderdale 33310
 305 522-1000
 Line: broadcast equip
 UMC see ad pg 14

BROADCAST EQUIPMENT CORP
 744 Nest Church St
 Orlando 32805
 305 423-8299
 Line: full line broadcast equip

FRED CANON & ASSOC
 Tropic Isle
 Delray Beach 33444
 205 278-1114
 Line: power supplies

**CONTINENTAL ELECTRONICS
 WHOLESALE CORP**
 1620 W 32 St

Hialeah 33012
 305 822-1421
 Line: audio & RF equip
 Inovonics see ad pg 116

CONTROLLED TECHNOLOGY INC
 2513 Tortugas Lane
 Ft Lauderdale 33312
 305 587-2716
 Line: full line audio & video equip
 UMC see ad pg 14

CRESCENDO ASSOC
 3821 SW 60th Ave
 Davie 33314
 305 791-1471
 Line: audio equip
 Otari see ad pgs 149, 151, 153

DESIGN LIVE INC
 5485 Jet Port Blvd
 Tampa 33614
 Line: audio & video equip

ELECTREX CO
 18680 NE 2nd Ave
 Miami 33179
 305 945-6483
 Line: audio & video equip
 Ramko see ad pgs 46-47

PR FERMAINTT
 1031 SW 74 Ct
 Miami 33144
 315 261-4755
 Line: audio & RF equip

FLORIDA VIDEO SYSTEMS
 14422 NW 7 Ave
 Miami 33168
 305 688-6618
 5089 NE 12 Ave
 Ft Lauderdale 33334
 305 771-4784
 Line: video & lighting equip
 Microtime see ad pg 66

CFRN CRY CKCY KBOX KGRO KLOE-TV KINT KLIN
 KNXV KPAC KRVN KYAK KYXY W
 WBOK WCBQ WFLN WDAR WDLB WFO
 WFTN WHAT WHP WIBF WIBX WIKZ WJAX WJW
 WKXL WKAP WLBR WLDS WLEW WLNH WLOB WLSW
 WRSC WLW WRVA WNNR W
 WSSV WTCM WSB WTRI WTYF



Model S-12 5 Mixer Stereo

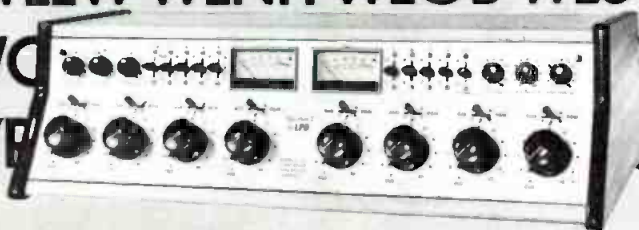

Model S-13C 8 Mixer Stereo/Mono

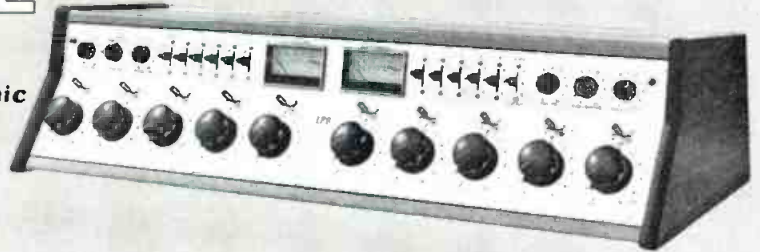

Model S-20 10 Mixer Dual Stereo

See us at NRBA, Booth #412

PERFORMANCE

LPB Signature II Series audio consoles are designed and manufactured to provide superb operational capability and outstanding electronic and mechanical reliability. Mono, dual mono or stereo . . . 5, 8 or 10 mixer configuration. Why look elsewhere?

LPB® LPB Inc.
 28 Bacton Hill Road, Frazer, PA 19355 (215) 644-1123
 Manufacturers and Distributors of Broadcast Equipment Since 1960

Reps/Dists

Florida continued GRAY COMMUNICATIONS

5401 Sothern Comfort Blvd
Tampa 33614
813 885-1411
Line: broadcast equip
Ampro Broadcasting see ad pg 94
ISI see ad pgs 52, 97, 180

GRA-MAR INC

3165 McCrory Pl
Orlando
Line: audio equip
Modular Audio see ad pg 187

HARRIS AUDIO SYSTEMS INC

1962 NE 149th St N
Miami 33181
305 944-4448
Line: full line audio equip
Inovonics see ad pg 116

JAMES L HIGHSMITH CO

4190 NW Oak Circle
Boca Raton 33431
305 368-9194
2545 Industrial Blvd
Orlando 32804
305 293-5202
Line: audio & video equip

HUTTO-HAWKINS-PEREGOY INC

PO Box 1277
Maitland 32751
305 831-2474
Line: audio equipment

IMAGE DEVICES INC

1825 NE 149th St
Miami 33181
305 945-1111
Line: video & audio equip

IVEY COMMUNICATIONS

744 W Church St
Orlando 32805
305 423-8299
Line: video equip
ISI see ad pgs 52, 97, 180
Microtime see ad pg 66

J&J ELECTRONICS

5855 Johnson St
Hollywood 33021
305 771-4784
Line: video production switchers, pulse & distribution amps, routing switchers, special effects generations

LAUDERDALE ELECTRONICS LABS

16 SW 13th St
Ft Lauderdale 33315
305 764-7755
Line: audio components
ESE see ad pg 196

LEE FLORIDA INC

PO Box 672
Winter Haven 33880
813 294-5815
110 Algonquin Terrace
Indian Harbor Beach 32937
305 773-8114
Line: full line broadcast equip
Marconi see ad pgs 63, 93

LYKES ELECTRONICS CORP

1800 NW 23rd St
Miami
5426 W Crenshaw
Tampa 33622
813 886-6621
Line: full line audio & video equip

MIDWEST TELECOMMUNICATIONS

3331 NW 82nd Ave
Miami 33122
305 592-5355
Line: audio & video equip, lighting equip
Conrac see ad pg 39
Digital Video Systems see Cover 3
ISI see ad pgs 52, 97, 180

MORT PRESS

1800 San Souci Blvd Suite 305
N Miami 33161
305 895-2262
Line: video components, equip

PHOTOMART

6237 S Orange Ave
Orlando 32809
305 851-2780
Line: video equip, lighting equip

RECORDING STUDIO EQUIPMENT CO

18917 NE 5th Ave
North Miami Beach 33179
305 949-8918
Line: broadcast equip
Orange County see ad pg 176

REPELECT

Box 7102
Tampa 33603
813 277-5051
Line: audio & video equip
Gorman Redlich see ad pg 193
Ramko see ad pgs 46-47
Sound Technology see ad pg 27
TFT see ad pg 75

REYNOLDS & ASSOC

476 North A1A-Suite 1A
Satellite Beach 32937
305 773-4700
Line: audio components

R&H ASSOC

PO Box 364
Safety Harbor 33572
Line: broadcast equip
NEC see ad pgs 86-87

SOUTHEAST ELECTRONICS

1125 Rouselle St
Jacksonville 32203
904 356-3007
Line: full line of audio/video equip
Microtime see ad pg 66

STAGE EQUIPMENT & LIGHTING INC

12231 NE 13 Ct
Miami 33161
305 891-2010
Line: lighting equip

SUN VIDEO COMM & PRODUCTIONS

8100 Ulmerton Rd
Largo 33541
813 886-6651
Line: video equip
Microtime see ad pg 66

SPROCH SALES INC

3520 W Broward Blvd
Ft Lauderdale 33312
305 587-3792
12 Anchor Way
Golf Harbor, Newport Richieu 33552
813 849-6067
Line: audio equip

UNITED ASSOC

2945 Bay St
Gulf Breeze 32561
904 932-5670
2925 Seminole St
Miami 33133
305 856-6749
320 W Park Dr
PO Box 2454
Ft Lauderdale 33315
305 523-0308
5020 Cypress St Suite 214
Tampa 33607
813 877-6091
PO Box 2308 J
119 Seewald St
Jacksonville 32203
904 354-5985
Line: video & lighting equip

URO-FI

9999 NE 2 Ave
Miami Shores 33138
305 893-3518
Line: audio equip

WORLD ELECTRONICS INC

18917 NE 5th Ave
Miami Beach 33160
305 949 8918
Line: audio equip

WORLD WIDE PRODUCTS

PO Box 279
Miami 33168
305 754-5475
Line: audio components, equip, tape recorders
Telex see ad pg 123

GEORGIA

ABSCOM INC

1411 Dresden Dr NE
Atlanta 30319
404 261-3031
Line: audio & video equip

CM ALLEN CO INC

6145 Barfield Rd NE Ste 180
Atlanta 30328
404 393-1721
Line: power supplies

ATLANTA FILM EQUIP RENTALS

1838 Briarwood Rd NE
Atlanta 30329
404 633-4101
Line: film & lighting equip

BCS ASSOCS

2522 Tanglewood Rd
Atlanta 30033
404 321-0980
Line: full line video equip

BROADCAST COMM ASSOC

105 Butternut Lane
Peachtree City 30269
404 487-9559
Line: audio & RF equip
LPB see ad pg 167
UMC see ad pg 14

CALHOUN COMPANY

121 Forrest Ave NE
Atlanta 30303
404 636-3096
Line: full line video/audio & lighting equip

CAVENDISH SALES CO

2737 Fountainbleau Dr
PO Box 47331
Atlanta 30360
Line: audio & video equip

ELECTRO ACOUSTIC SYSTEMS

1093 Blvd
Athens 30601
404 353-1283
Line: audio equip
ADR see ad pg 179

ELECTRONIC EQUIPMENT INC

526 Plaster Ave NE
Atlanta 30324
404 873-5841
Line: audio components & equip
Conrac see ad pg 39
ISI see ad pgs 52, 97, 180

ELREP SALES CO

PO Box 61
Tucker 30084
404 938-7108
Line: Video equip

EME INC

2522 Tanglewood Rd
Decatur 30033
404 325-0165
Line: broadcast equip
TFT see ad pg 75

FIDELICOM INC

PO Box 80644
Chamblee Station
Atlanta 30341
404 458-3616

3115 Marjan Dr
Doreville 30340
Line: audio equip, test equip
Otrari see ad pgs 149, 151, 153
Sound Technology see ad pg 27

GEORGIA BROADCASTING

Box 13646
Savannah 31406
912 354-4000
Line: full line A.V equip

GRADY DUCKETT SALES

PO Box 29067
Atlanta 30329
404 451-3529
Line: audio systems, components
Tech Labs see ad pg 205

GRAY COMMUNICATIONS

1709 Stuart Ave
Albany 31755
912 435-8386
3684 Clearview Ave
Doraville 30340
404 455-3121
Line: audio & video equip, video systems
Ikegami see ad pgs 53, 158-159
ISI see ad pgs 52, 97, 180
Echo Science see ad pgs 64-65

C HARRISON ASSOCS

6290 McDonough Dr Ste 2
Norcross 30093
404 449-7696
Line: audio & video equip

PAUL HAYDEN ASSOC

PO Box 90668
1530 Mabell Ave
East Point 30364
404 766-0261
Line: video equip

CHARLES JOHNSON

1213 Lake Hearn Pl NE
Atlanta 30319
404 255-2202
Line: video & lighting equip

AIRE LANDRUM

2390 Tiffany Circle
Decatur 30032
404 288-2080
Line: video equip

MAGARO ASSOC

PO Box 76652
Atlanta 30328
Line: video equip
Echo Science see ad pgs 64-65

MILLAR ELECTRONICS INC

PO Box 12137
Northside Station
Atlanta 30305
404 261-6160
Line: audio equip

PAY TV SERVICES

3718 Woodsing Ct
Dunwoode 30338
404 394-3467
Line: video equip
Microtime see ad pg 66

RADFORD ASSOCS

3203 Lanier Dr
Atlanta 30319
404 237-6097
Line: full line broadcast equip
Asaca see ad pg 19
Knox see ad pg 35

ROSCOM INC

PO Box 54129
Atlanta 30308
404 577-4689
Line: audio equip
ESE see ad pg 196
Ramko see ad pgs 46-47

SPHERE AUDIO SALES

6985-B Roswell Rd NE
Atlanta 30328
404 393-9474
Line: full line audio equip
BTX see ad pg 182

continued on page 170

“These Auditronics 501 modules are all that survived the fire...

that totally destroyed our East 46th Street Superdupe and SDC Recording Studio complex last year,” says Herb Gordon, studio owner. “Almost before the wreckage cooled and the insurance adjuster completed his work, I was already planning the equipment purchases we would need to get back into business.”

“In all the years we had the Auditronics 501 consoles prior to the disaster, I don’t remember anything going bad. Our purposes were well served by our old 501s, so I went back to Auditronics the week after the fire to order three more of the latest model 501s.”

Herb Gordon and over 300 other satisfied users of Auditronics mixing consoles have learned much about Auditronics performance, quality and reliability since we delivered our first 501 back in 1971. If you would like to know what they know, call or write for complete product information and the name of your nearest Auditronics dealer.

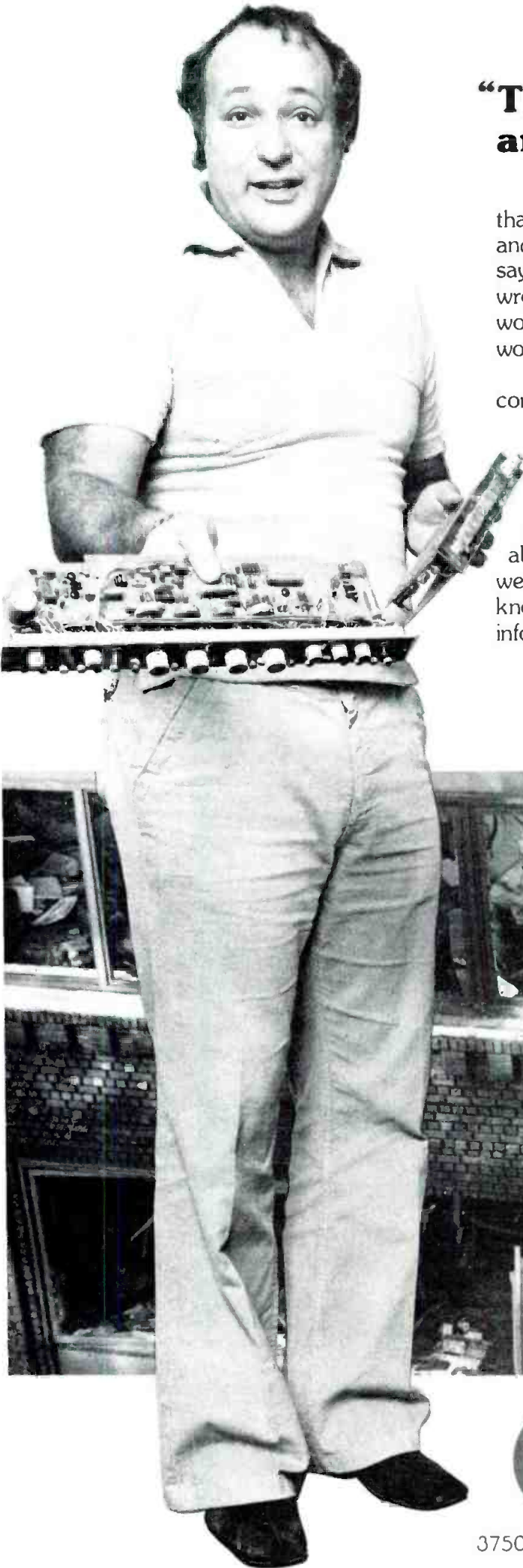

auditronics, inc.

3750 Old Getwell Road, Memphis, Tennessee 38118 (901) 362-1350

Circle 210 on Reader Service Card

www.americanradiohistory.com

Reps/Dists

Georgia continued

MAITLAND K SMITH INC
2321 4 St Ste 210
Tucker 30084
404 939-3323
Line: audio equip

SPRADLIN BROS STAGE LIGHTING
PO Box 149
Red Oak 30272
404 964-2495
Line: lighting equip

STANCO COMM PRODUCTS
PO Box 29921
1639 Tully Cir NE Ste 109
Atlanta 30329
404 636-3096
Line: audio & video equip

TECHNICAL INDUSTRIES
6000 Peachtree Rd
Atlanta 30341
404 455-7610
Line: video equip
ISI see ad pgs 52, 97, 180

TECHNICAL SYSTEMS REPS
2065 Peachtree Ct Ste 215
Chamblee 30341
404 457-0426
Line: audio equip
Telex see ad pg 123
UREI see ad pg 107

VISUAL SYSTEMS
3870 N Peachtree Rd
Atlanta 30341
404 457-1388
Line: video equip
Microtime see ad pg 66

TRACKSIDE ENGINEERING
661 San Fernando Dr
Smyrna 30080
404 436-3024
Line: audio equip

HAWAII

ATECS CORP
156 Mokavea St
Honolulu 96819
Line: video equip
Echo Science see ad pgs 64-65

ATTCO
28855 Koapaka St
Honolulu 96819
808 841-0991
Line: video & lighting equip

AUDISSEY
679 Auahi St
Honolulu 96813
808 521-6791
Line: audio equip
ADR see ad pg 179

THE AUDIO VISUAL CO
875 Waimanu St
Honolulu 96813
808 533-3848
Line: audio & video equip
Microtime see ad pg 66

BRADY PHOTO
92564 Pailailai St
Ewa Beach 96706
808 672-3479
Line: lighting equip

BROADCAST SERVICES INC
2877 Kalakaua Ave
Honolulu 96815
808 521-6311

Line: audio & RF equip
Ramko see ad pgs 46-47
UMC see ad pg 14

MATT CABOT & ASSOC
PO Box 3780
1210 Auahi St #120
Honolulu 96814
808 533-1867
Line: video & lighting equip

ELECTRONIC SYSTEMS INC
875 Waimana St Suite 500
Honolulu 96813
808 533-3848
Line: full line of audio/video equip

EMC CORP
Dave Caldwell
2979 Ualena St
Honolulu 96819
808 836-1138
Line: video & test equip
Knox see ad pg 35

LEE GABER CO
PO Box 8237
Honolulu 96815
808 839-9059
Line: full line audio equip

JOHN J HARDING CO LTD
2825 Valena St
Honolulu 96819
808 836-0941
Line: broadcast equip
Inovonics see ad pg 116

HAWAII BROADCAST ASSOC
PO Box 1344
Honolulu 96806
808 537-3991
Line: broadcast equip

JC ELECTRONICS
PO Box 27185 Honolulu 96827
808 836-3449

Line: audio equip
UREI see ad pg 107

OMEGA PACIFIC
570 Auahi St Ste 204
Honolulu 96813
808 533-7655
Line: video equip
Microtime see ad pg 66

PACIFIC MEDIA CONSULTANTS
1001 Dillingham Blvd Suite 207A
Honolulu 96817
808 841-4021
Line: audio & video equip

IDAHO

HOWE INC
PO Box 804
651 Main St
Rexburg 83440
208 356-5200
Line: full line audio equip

THOMAS HILL BDCST CONSULTANTS
1300 Hill Rd
Boise 83702
208 342-6902
Line: audio equip
Ramko see ad pgs 46-47

ILLINOIS

ADVANCED VIDEO COMMUNICATIONS
49 S Washington St
Hinsdale 60521
312 323-7464
Line: video equip
Microtime see ad pg 66

FrezziTM ENERGY High-Capacity Battery Packs

See **FREZZOLINI®** at SMPTE, Los Angeles, Booths 428-429 Oct. 21-26, 1977



This is "Frezzi-Belt" Model F-12-77. It powers Ikegami Model 37/77/79 Video Cameras.



Less than 1 hour re-charge time with "Frezzi-Fast"™ Chargers.

These are Model FBP Frezzi plug-in Battery Packs for the JVC CR-4400LU Videocassette Recorder

Portable power for all video cameras, video recorders, and hand-held "Frezzi"™ Lights.

For information: (New Jersey 201) 427-1160 or (New York 212) 594-2294.

Frezzolini 16mm ciné cameras & E.N.G. support equipment.



Frezzolini Electronics Inc.

Made in U.S.A.

7 Valley St. Hawthorne, N.J. 07506 USA

Export Agents:

CINECRAFT INTERNATIONAL INC 11 Caesar Place, Moonachie, New Jersey 07074 USA • (201) 939-0875 • Cables: Cinecraft Moonachie • Telex: Cinecraft Moon TLX 13-8875

Circle 211 on Reader Service Card

ALEXANDER BATTERY
Palatine
425 S Elm St 60067
312 359-1075
Line: broadcasting equip
Alexander see ad pg 104

ALL MEDIA SALES CO
1535 Foxhill Rd
Naperville 60540
312 628-0840
Line: video equip
Knox see ad pg 35

ANCHA ELECTRONICS
189 Gordin Street
Elk Grove Village 60007
312 437-7712
Line: audio video equip
ISI see ad pgs 52, 97, 180

AUDIO RESOURCES
825 N Kass Ave Ste 206
Westmont 60559
312 655-1180
Line: audio equip
Otari see ad pgs 149, 151, 153

BELL & HOWELL
2411 Howard St
Evanston 60645
312 869-9393
Line: full line film & video equip

LARRY BROWN
303 Greenfield
Lombard 60148
312 609-1664
Line: full line video equip, lighting

BSC INC
2932 River Rd
River Grove 60171
312 452-5551
Line: audio equip

**COZZENS & CUDAHY SALES
GROUP**
1400 Hicks Rd

Rolling Meadows 60003
312 398-0850
Line: test & monitoring instruments

CRIMSON ENGINEERING CO
PO Box 286
Glenview 60025
312 446-6316
Line: audio equip
Tech Labs see ad pg 205

VICTOR DUNCAN INC
676 St Clair St
Chicago 60611
312 321-9406
Line: full line video, film,
lighting equip

RODGER EKENBERG
1010 S Edgewood
Lombard 60148
312 495-1948
312 495-1948
Line: full line audio & video equip

BARNEY GEOLAT
6400 W Main
Belleville 62223
618 397-9251
Line: full line audio & video equip

GRAND STAGE LIGHTING
630 W Lake St
Chicago 60606
312 332-5611
Line: lighting equip

HELIX LTD
679 N Orleans
Chicago 60610
312 944-4400
Line: video & lighting equip

DWIGHT HERBERT
100 E Ohio St
Chicago 60611
800 621-6836

Line: full line bdcst equip
Auto Bdcst Controls
see ad pgs 184, 204

RAY R HUTMACHER ASSOC INC
7205 W Pratt Ave
Chicago 60631
312 631-3248
Line: audio components,
communications equip, tape recorders

WILLIAM M LINZ ASSOC
821 Skokie Blvd
Northbrook 60062
312 498-9600
Line: audio equip; components
Telex see ad pg 123

McCURDY RADIO IND INC
1711 Carment Dr
Elk Grove Village 60007
312 640-7077
Line: audio & tape accessories
UMC see ad pg 14

MEADE ELECTRONICS CO INC
3100 S 25 St
Broadview 60153
312 344-4174
Line: audio components
BTX see ad pg 182
Conrac see ad pg 39

KENNETH MEYERS
7442 N Harlew
Chicago 60648
312 882-4808
1242 Remington Rd
Schaumburg 60195
312 882-4808
Line: full line & video equip
Marconi see ad pgs 63, 93

MIDWEST BROADCAST SUPPLY
612 N Michigan Ave Ste 507
Chicago 60611
312 822-0919
Line: professional broadcast equip

LPB see ad pg 167
UMC see ad pg 14

MIDWEST SOUND CO
4346 West 63rd St
Chicago 60629
312 767-7272
Line: broadcasting equip
Orange County see ad pg 176

MILAM AUDIO CORP
1504 N 8 St
Pekin 61554
309 346-3161
Line: audio components, equip;
recorders
ADR see ad pg 179

OTTAWA EQUIP
6838 N Ottawa
Chicago 60631
312 774-5115
Line: audio & video equip

THEODORE PAPPAS ASSOC
5218 W Diversey Ave
Chicago 60639
312 685-2338
Line: audio equip
Logitek see ad pg 188
Otari see ad pgs 149, 151, 153
UREI see ad pg 107

GEORGE PETITT CO INC
50300 A McDermot Dr
Berkeley 60163
312 261-0342
505 Avandale Dr
E Peoria 61611
309 699-3301
Line: audio equip

RCA SERVICE CO
1263A Grand Rd
Des Plaines 60016
312 298-7980
Line: full line broadcast equip
Microtime see ad pg 66

CHYRON

The electronic graphics people

CHYRON TELESYSTEMS DIVISION OF CHYRON CORPORATION

265 Bethpage-Spagnoli Road, Melville, New York 11746

Telephone: (516) 249-3296 ■ Telex: 144522 CHYRON MELV

VISIT US AT SMPTE BOOTH 522

Reps/Dists

Illinois continued

RICH INC

3531-35 N Martens St
Franklin Park 60131
312 678-3100
Line: audio & video equip

IRVING ROSE ASSOCS

3333 Commercial Ave
Northbrook 60062
312 291-2260
Line: audio and video equip
Sound Technology see ad pg 27

ROSCOR CORP

6160 W Oakton St
Morton Grove 60053
312 539-7700
Line: full line video equip
CEI see ad pg 105
Ikegami see ad pgs 53, 158-159
ISI see ad pgs 52, 97, 180

HOWARD SPRACKLEN

905 S Neil St
Champaign 61820
Line: video equip

SWIDERSKI ELECTRONICS

1200 Greenleaf Ave
Elk Grove Village 60007
312 364-2900
Line: audio & video equip,
lighting equip
Conrac see ad pg 39
Echo Science see ad pgs 64-65
Microtime see ad pg 66

STUDIO ELECTRONICS

3252 W Foster
Chicago 60625
312 478-2050
Line full line of audio & lighting equip
Inovonics see ad pg 116

INDIANA

ALLIED BROADCAST EQUIP

PO Box 786
Richmond 47374
317 962-8596
Line: audio equip for radio
ESE see ad pg 196
Orange County see ad pg 176
Russco see ad pg 181

AUDIO VISUAL SPECIALIST

3753 Northrop St
Forth Wayne 46805
219 483-0528
Line: full line audio & visual equip

B&A ELECTRONICS

Terre Haute
812 232-1061
Line: audio & video equip

COMMUNICATIONS SYSTEMS

1338 Mishawaka Ave
South Bend 46615
219 289-6709
Line: video equip

COZZENS & CUDAHY SALES GROUP

5610 Crawfordsvill Rd Ste 803
Indianapolis 46224
317 244-2456
Line: full line audio & video equip

ELECTRONIC SYNERGY INC

4858 N 13 St
Terre Haute 47805
812 466-6868
5335 N Tacoma Ste 20
Indianapolis 46220
317 251-0800
Line: full line of video equip
ISI see ad pgs 52, 97, 180

GRAHAM ELECTRONICS

133 South Penn St
Indianapolis 46204
317 634-8202
Line: audio components

INDIANAPOLIS VIDEO

6226 LaPas Trail
Indianapolis 46268
317 293-3313
Line: video equip, lighting equip
Microtime see ad pg 66

INDY LIGHTING

8002 Castleway Ct
Indianapolis 46250
317 849-1233
Line: full line lighting equip

JACKSON KEITH AND ASSOCIATES, INC

PO Box 65
365 Walnut
Zionsville 46077
318 873-4079
Line: audio and test equip

KLOPF AUDIO/VIDEO CO

1011 Merchants Barik Bldg
Indianapolis 46204
417 926-3919
Line: broadcast equip
ISI see ad pgs 52, 97, 180

MAISH SALES

PO Box 186
500 Madison Street
Mulberry 46058
217 296-2322
Line: audio & test equip
Sound Technology see ad pg 27

MEADE ELECTRONIC CO

1825 Summer St
Hammond 46320
219 932-2100
Line: audio & video products

KENNETH MEYERS CO

3512 Rockville Rd
Indianapolis 46222
317 243-6681
Line: test equip TV & radio equip
Marconi see ad pgs 63, 93

ROBERT MILSK CO

2511 E 46th St Ste Q-4
Indianapolis 46205
317 546-5468
Line: audio equip: components
Telex see ad pg 123

New Era Sales Inc.

316 S Range Line Rd Ste C
Carmel 46032
317 844-4530
Line: audio equip

SUKUP & COX INC

2070 E 54th St
Indianapolis 46220
317 253-5501
Line: audio components & equip

S Wade & Co

7030 E 116 St
Noblesville 46060
Line: full line audio equip

IOWA

BEAMS INC

2318 (14B) Harding Rd
Des Moines 50314
515 255-1148
Line: audio equip

CELESTIAL POWER & LIGHT

1424 Scott Ave
Des Moines 50317
515 243-0818
Line: audio & video equip

IOWA AUDIO VISUAL

2740 30th St
Des Moines 50310
515 279-3672

KIMIAN SALES CO

1804 Sycamore St
Allantic 50022
712-243-1626
Line: audio components; equip

MASTERTONE CO

1st National Bank Bldg Ste 22
515 225-6122
Line: full line audio equip;
transmitters, monitors

MIDWEST VISUAL EDUCATION

2709 Ingersoll Ave
Des Moines 50312
Line: full line lighting equip

ROBERT H MILLER

9312 Ridgemont Dr
Des Moines 50322
515 276-2115
Line: power supplies

PACER CORP

1714 Beaver Ave
Des Moines 50310
515 274-3224
Line: video equip

VIDEO MIDWEST

2212 Ingersoll Ave
Des Moines 50310
515 244-1447
1017 State St
Batlendorf 52722
515 359-0397
Line: video & lighting equip
Microtime see ad pg 66

KANSAS

BEAMS INC

11593 W 75 St
Shawnee Mission 66214
913 631-0301
Line: audio equip

CENTREX AUDIO VISUAL

216 SW 6th St
Topeka 66604
913 232-7701
Line: audio & video equip
Microtime see ad pg 66

DYTE/SOUTH INC

8245 Nieman Rd
Lenexa 66214
913 888-0212
Line: audio & video equip

JIM GRUNDER

8812 Santa Fee Ln
Overland Park 66212
913 831-0188
Line: video equip
Knox see ad pg 35

HOOVER BROS INC

1511 Baltimore
Kansas City 64108
816 221-7663
Line: full line visual lighting equip

MERTON KNOLD

PO Box 301
Atchison 66602
913 367-1146
Line: audio & video equip

WILLIAM MENEZES & ASSOCS

9604 Nall St
PO Box 7070
Overland Park 66207
913 649-2680
Line: audio and video equip
Sound Technology see ad pg 27

MIDTEC ASSOC

6912 Marion
Shawnee Mission 66218
913 441-6565
Line: audio & video equip
Tech Labs see ad pg 205

PACER CORP

8511 W 69 St
Shawnee Mission 66204
Line: video equip

RADIO SUPPLY CO

131 S Laura
PO Pox 1220
Wichita 67211
316 267-5213
Line: audio equip

STEVE SMITH CAMERAS

623 Kansas Ave
Topeka 66603
913 235-3481
Line: full line camera & lighting equip

THEATRICAL SERVICES INC

123 E Douglas Ave
Wichita 67202
316 263-4415
Line: full line lighting equip

VIDEO MASTERS INC

1820 Wyandotte
Kansas City 64108
816-474-8530
Line: full line video lighting equip

KENTUCKY

AMERICAN SOUND & ELECTRONICS

675 W Third St
Covington 41011
606 261-9024
Line: video and audio equip

CENTURY SOUND & RECORDING

3029 Oregon St
Paucah 42001
502 554-2722
Line: audio equip

BRUCK L DAWSON

PO Box 115
Prospect 40059
502 228-4898
Line: video equip, cameras, lenses
Knox see ad pg 35

ELECTRONIC LABS INC

800 S 4 St Ste 2002
Louisville 40203
502 583-2312
Line: audio & video equip

ELECTRONIC SYNERGY INC

5800 Fern Valley Rd Ste 7
Louisville
502 966-4211
655 Maxwellton Ct
Lexington 40508
606 254-4887
Line: full line audio & video, lighting equip

MIDWEST TELECOMMUNICATIONS

1804 Cargo Ct
Louisville 40299
502 491-2888
Line: video equip
Digital Video Systems
see ad Cover 3
ISI see ad pgs 52, 97, 180

SONIC SERVICES

818 Grade Lane
Louisville
502 367-2823
Line: audio & recording equip
Inovonics see ad pg 116

LOUISIANA

AUDIOMEDIA ASSOCS

PO Box 29264
New Orleans 70189
504 242-8104
Line: audio components, radio
transmitters
Inovonics see ad pg 116
LPB see ad pg 167

continued on page 174

WWDL-FM and WICK-AM

WE CAN BE AS FLEXIBLE AS WE WANT TO BE, AND WE'RE COST-EFFECTIVE ALL THE WAY™

Doug Lane operates two fine radio stations in Scranton with just *one* fine broadcast staff, *two* Cetec System 7000 automation systems, and a minicomputer-based station business system. And a lot of creative management.

"Our System 7000s let us do the things we want to do in broadcasting in a cost-effective way," Doug Lane says. That means almost unlimited program flexibility, live, remote sports and news coverage, seven days of programming "memorized" in advance, consistently superior audio quality. Network "joins" and "cutaways" that are clean and precise. Voice tracks recorded within minutes of on-air time. Automatic logging/printing of every broadcast event.

And with an SBS system handling most of the business paperwork, Lane Broadcasting is an outstanding example of digital electronics as a partner in good broadcast management.

Fifteen people operate two radio stations with top-quality style and versatility. Thirteen of them operate the System 7000 keyboards. Small wonder that WWDL-FM and WICK-AM are getting so much attention from listeners. And advertisers. And radio broadcasters from across the nation.

It's a "quality in, quality out" operation. Doug Lane directs the programming quality and content. The twin Cetec System 7000s take it from there, following orders with precision, clean audio, and that remarkable Z80-based controller.

System 7000 can open new programming horizons for *any* radio station. Write or telephone today, and ask us to prove it.

 **Cetec Broadcast Group**

1110 Mark Avenue, Carpinteria, Ca 93013 (805) 684-7686



Circle 213 on Reader Service Card

AT NRBA IN WASHINGTON
CETEC BROADCAST GROUP PRESENTS
"WWDL IN SCRANTON"
featuring Doug Lane and the System 7000
in discussion and demonstration
OCT. 7-10 BANCROFT SUITE
WASHINGTON HILTON

Reps/Dists

Louisiana continued

BASS ELECTRONICS

1591 S Elaine Dr
Baton Rouge 70815
504 927-0282
Line: audio & video equip

GRAY COMMUNICATIONS

5441 Pepsi St
New Orleans 70173
504 733-7265
Line: video equip
Ikegami see ad pgs 53, 158-159
ISI see ad pgs 52, 97, 180

INTERSTATE SCHOOL SUPPLY

PO Box 3385
1835 River Rd N
Baton Rouge 70821
504 387-5131
Line: audio & video equip
Microtime see ad pg 66

PAUL KADAIRES INC

4773 Convention St
Baton Rouge 70806
504 924-1001
Line: audio equip
ADR see ad pg 179

LYKES ELECTRONICS

5745 Jefferson Hwy
New Orleans 70123
504 733-3400
Line: audio & video equip

MZB & ASSOC

440 No Foster Dr
Baton Rouge 70806
504 926-8287
Line: audio equip
Ramko see ad pgs 46-47

CORY MYERS

4657 Michoud Blvd Ste 5
New Orleans 70129
504 586-0140
Line: full line bdcst equip
Auto Bdcst Controls
see ad pgs 188, 204

SOUND CENTER

316 Shennandoah
Bogalusa 70427
504 735-8211
Line: Broadcasting equip
Orange County see ad pg 176

MAINE

JIM BOLDEBROOK

RFD #3
Gorham 04038
207 929-6736
Line: broadcast equip
Cetec see ad pgs 31, 173

MAINE VIDEO

468 Forest Ave
Portland 04101
207 773-2355
Line: video equip
Microtime see ad pg 66

MG ASSOC

Box 4245 Station A
Portland 04101
Line: video equip

MARYLAND

ABH SALES CORP

PO Box 111
Grasonville 21638
301 827-8046
Line: audio equip

ASSOCIATED SALES REPS

403 Fieldstone Ct

Fallston 21047
301 877-7300
Line: audio equip
Otari see ad pgs 149, 151, 153

BARTLETT ASSOCIATES INC

4405 East West Highway
Bethesda 20014
301 656-3061
Line: video equip, switchers
Cohu see ad pg 178

GENE BIDUN & ASSOC

PO Box 861
Columbia 21044
301 992-4444
Line: RF equip
Cetec see ad pgs 31, 173
Gorman-Redlich see ad pg 193

DAVID H BROTHERS CO

19 Old Court Rd
Baltimore 21208
301 764-7189
Line: audio equip; components
Telex see ad pg 123

COMMERCIAL VIDEO REPS

2637 N Charles St
Baltimore 21218
301 235-9120
Line: video equip
Knox see ad pg 35

GT ASSOC

6501 Griffith Rd
Laytonsville 20760
Line: video equip
Echo Science see ad pgs 64-65

HABCO ELECT

603 Alleghaney Ave
Towson 21204
301 825-9637
Line: audio, video components

HAYDEN ASSOC

16 Decatur Ave
Annapolis 21403
202 296-6059
Line: broadcast equip
TFT see ad pg 75

INTERNATIONAL SOUND CORP

7102 Milford Industrial Rd
Pikerville 21208
301 484-2244
Line: video equip

LRS DISTR CO

29 Stonehenge Circle
Baltimore 21208
301 484-7750
Line: broadcast equip

LUMAR ASSOC

5801 Annapolis Rd Ste 306
Bladensburg 20710
301 864-0997
Line: video equip

MID-ATLANTIC SALES GROUP

1150 Huff Ct
Kensington 20795
301 881-3370
Line: audio & video instruments

MIDWEST CORP

4700-G Boston Way
Lanham 20801
301 577-4903
Line: audio & video equip
Conrac see ad pg 39
Digital Video Systems
see ad Cover 3
ISI see ad pgs 52, 97, 180
Microtime see ad pg 66

NEFF COMMUNICATIONS

9721 Singleton Dr
Bethesda 20034
301 530-6080
Line: audio equip
Ramko see ad pgs 46-47

PIERCE PHELPS INC

10215 Fernwood
Bethesda 22038
301 530-9580

Line: full line video equip,
lighting equip
ADDA see ad pgs 23, 101
CEI see ad pg 105
ISI see ad pgs 52, 97, 180

ED PIETRAS

2121 Baldwin Ave Ste 25A
Crofton 21114
301 261-3233
Line: full line audio & video equip

PROFESSIONAL PRODUCTS INC

4964 Fairmont Ave
Bethesda 20014
301 657-2141
Line: full line video products,
lighting equip

Echo Science see ad pgs 64-65
ISI see ad pgs 52, 97, 180

RECORDING CONSULTANTS INC

8550 2nd Ave
Silver Springs 22910
301 587-1800
Line: full line of audio equip
Inovonics see ad pg 116

R&R LIGHTING

622 Mississippi Ave
Silver Springs 20910
301 589-9025
Line: lighting equip

SELINGER & ASSOC

5415 Butler Rd
Bethesda 20016
Line: audio & video equip

SEL-TRONICS INC

721 Ellsworth Dr
Silver Springs 20910
301 589-3391
Line: full line audio & video equip

S&S ASSOCS

4924 Hampden Lane
Bethesda 20014
301 654-1434
Line: test instruments
Marconi see ad pgs 63, 93

TAUB SALES INC

12244 Viers Mill Rd
Wheaton 20906
Line: video & audio equip

TECHNIARTS

8555 Fenton Street
Silver Spring 20910
301 585-1118
Line: broadcasting equip
Orange County see ad pg 176

VIDEO SHOWCASE INC

7148 Ambassador Rd
Security Industrial Pk
Baltimore 21207
Line: video equip

VIRGINIA-MARYLAND ASSOC INC

3414 First Ave
Olney 20832
301 774-3388
Line: power supplies

VISUAL INFORMATION SYSTEMS

Owing Mills
301 363-6390
Line: video equip

WILTRONIX INC

5504 Waterway
Rockville 20853
301 460-1454
Line: broadcast equip & access

WS WARRINGTON & ASSOC

PO Box 313
Riderwood 21139
301 823-8759
Line: audio equipment
Tech Labs see ad pg 205

MASSACHUSETTS

CRAMER VIDEO

120 Hampton Ave
Needham 02194
617 449-2100
Line: video equip

CRIMSON CAMERA

60 Landsdown St
Cambridge 02139
603 434-0731
Line: video lighting equip

EASTERN BROADCAST SUPPLY

46 Mechanic St
Leominster 01453
617 537-4706
Line: broadcast equip
UMC see ad pg 14

FELDMAN AUDIO

53 Southgate Park
Newton 02165
617 965-3116
Line: full line audio equip

INDUSTRIAL COMPONENTS CORP

2551 Boston Rd
N Wilbraham 01067
413 596-3854
Line: audio components

IRI SALES GROUP

244 Second Ave
Waltham 02154
617 890-1600
Line: test & monitoring instruments

KEN CORP

38 Montvale Ave
Stoneham 02180
617 438-5464
Line: test instruments
Marconi see ad pgs 63, 93

LAKE SYSTEMS CORP

55 Chapel St
Newton 02160
617 244-6881
Line: full line audio, video &
lighting equip
ADDA see ad pgs 23, 101
CEI see ad pg 105
ISI see ad pgs 52, 97, 180
Microtime see ad pg 66
Tweed see ad pg 183

LEBOW LABS

424 Cambridge St
Allston 02134
617 782-0600
Line: full line audio & video equip
Inovonics see ad pg 116
ISI see ad pgs 52, 97, 180
Microtime see ad pg 66
Orange County see ad pg 176

MALCO ELECTRONICS

5 Wolcott Ave
Lawrence 01843
617 685-4383
Line: video equip

FRANK MCCABE

7 Cobb Terrace
Walpole 02081
617 668-6736
Line: audio components, test equip

W McFADDEN

755 Washington St
Annisquam
617 283-7507
Line: radio equip, audio

MICRO-TRAK CORP

620 Race St
Holyoke 01040
413 536-3551
Line: full line audio equip

MULLIN TECHNICAL SALES CO INC

945 Great Plain Ave
Needham 02192
617 444-4780
Line: audio equip

continued on page 176

WHY FUJI?

Just a few short years ago, few people in the industry even knew our name. Let alone, what we stood for.

Then we introduced H701E—the low noise, high-band broadcast videotape that gave the industry a whole new set of performance standards. And Beridox.

A videocassette tape formulation combining the best features of chromium and ferric oxide. Now available in one-inch, as well.



Now, it seems a lot of people are standing in line for our products. Because they know—and like—what we stand for.

Fuji. Count on us to improve your image. For more information, write or call.

FUJI

Magnetic Tape Division of Fuji Photo Film U.S.A., Inc.
350 Fifth Avenue, New York 10001 (212) 736-3335
West-Coast: 1211 East Artesia Blvd., Carson, CA 90746
Midwest: 610 Bonnie Lane, Elk Grove Village, IL 60007
Southwest: 3500 Gardenbrook Drive, Dallas, TX 75234

Circle 214 on Reader Service Card

www.americanradiohistory.com

Reps/Dists

Massachusetts continued

NBE INC

Box 188/1 Cottage St
E Hampton 01027
413 527-4430

Line: full line transmitting equip

NEREM

64 Whittier Rd
Wakefield 01880

Line: audio equip

Modular Audio see ad pg 187

JAMES PIPER & ASSOC

33 Marsh St
Needham 02192
617 449-1144

Line: audio & video

PROFESSIONAL VIDEO SYSTEMS INC

1616 Soldier's Field Rd
Boston 02135

Line: full line video equip

Echo Science see ad pgs 64-65

NEC see ad pgs 86-87

PVS INC

1616 Soldiers Field Rd
Boston 02135
617 254-2101

Line: video, transmitting & measuring equip

Digital Video Systems
see ad Cover 3

QSI SYSTEMS INC

993 Watertown St
W Newton 02165
617 969-7118

Line: audio & video equip

Conrac see ad pg 39

JOHN RING & ASSOC

Box 138

East Hampton 01027

413 527-4430

Line: RF equip

Gorman - Redlich see ad pg 193

Halliakinen & Friends see ad pg 122

Orange County see ad pg 176

MICHAEL SCOTT CO INC

20 Walnut St
Wellesley Hills 02181
617 235-0102

Line: audio components; equip

Telex see ad pg 123

RING ASSOC INC

Box 188
Easthampton 01027
413 527-4430

Line: broadcast equip

Inovonics see ad pg 116

Orange County see ad pg 176

RJ SICKLES ASSOC

12 Cambridge St
Burlington 01803
617 272-7285

Line: audio & video equip

F M VALENTI

16 Saddle Club Rd
Lexington 02173
617 861-0089

Line: audio equip, video equip, camera lenses

V F SALES, INC

181 Worcester Rd
Route #9
Natick 01760
617 237-6544

Line: audio & video products

Otari see ad pgs 149, 151, 153

UREI see ad pg 107

WAHLBERG ASSOC

79 Mystic St
Arlington 02174

617 646-5394

Line: video equip

Knox see ad pg 35

MICHIGAN

R A ALBRECHT & COMPANY

PO Box 410
4379 Orion Rd
Rochester 48063
313 652-2520

Line: audio components, test equip

Sound Technology see ad pg 27

AUDIO DISTRIBUTORS

2343 Division Ave S
Grand Rapids 49507
616 452-1596

Line: full line of radio, RF equip

ESE see ad pg 196

Inovonics see ad pg 116

LPB see ad pg 167

UMC see ad pg 14

CHAMPAGNE SALES CO

3645 Crooks Rd
Troy 48084
313 649-4428

Line: audio equip

Ramko see ad pgs 46-47

CRUSE COMMUNICATIONS CO

4903 Dawn Ave
E Lansing 48823
517 332-3579

Line: video & lighting equip

Digital Video Systems

see ad Cover 3

VICTOR DUNCAN INC

11043 Gratiot Ave
Detroit 48213
313 371-4920

Line: photo supplies & equip, lighting equip

H M DYER ELECTRONICS

31185 Ten Mile Rd
Framington Hills 48024
313 478-2157

Line: full line broadcast equip

ADDA see ad pgs 23, 101

Asaca see ad pg 19

Datatek see ad pg 99

Knox see ad pg 35

Orange County see ad pg 176

J MALCOLM FLORA INC

PO Box 201
Plymouth 48170
313 453-4296

Line: audio equip

GENERAL TELEVISION NETWORK

13225 Capital Avenue
Oak Park 48237
313 548-2500

Line: audio components, lighting equip, video equip

Microtime see ad pg 66

R P HERMES CO

9600 Whittier St
Detroit 48224
313 886-4566

Line: audio & video equip

Conrac see ad pg 39

DAVE HILL

7641 19 Mile Rd
Sterling Heights 48077
313 739-7020

Line: broadcast equip

Cetec see ad pgs 31, 173

MICRO SALES CORP

595 Forest
Plymouth 48170
313 459-9444

Line: audio & video equip

NEWMAN VISUAL EDUCATION INC

400 32 St SE

continued on page 178

Stressing Quality



The Orange County VS-1 Stressor belongs in your AM chain, working quietly and reliably, as well as in your production studio, helping you produce powerful spots and promotions. And for "D.J. mike" enhancement, the VS-1 will give you extraordinary punch and impact on the air.

- Ultra-fast peak limiter with 250:1 slope for absolute overmodulation protection
- Compressor with adjustable ratio, threshold, attack and release times, for loudness enhancement
- Highly effective expander/noise-gate for noise reduction
- Powerful parametric equalizer
- Adjustable limiter asymmetry for positive peak modulation
- Performance specs and construction to the highest industry standard

Also investigate the VS-2 Stressor, which offers internally pre-set functions for the budget-conscious station looking for great sound.



ORANGE COUNTY ELECTRONICS
INTERNATIONAL INC.

Exclusive Sales & Marketing:

Parasound

680 Beach Street, San Francisco, Ca. 94109 (415) 673-4544

Dealer Inquiries Invited

Circle 215 on Reader Service Card



**ELECTRONIC INTERLOCK
MAGNETIC FILM
RECORDERS and REPRODUCERS
THE STANDARD OF HOLLYWOOD
AND THE WORLD**

**FOR FILM AND TELEVISION RE-RECORDING
ELECTRONIC LOOPING
HIGH SPEED DUBBING
TELECINE MAGNETIC FOLLOWERS
HIGH SPEED PROJECTORS
VIDEO TAPE-FILM INTERLOCK SYSTEMS
TOTAL FACILITY ENGINEERING**

Sydney
Magna-Techtronics (Aust.) Pty., Ltd.
P.O. Box 150
Crows Nest NSW 2064, Australia
Telex 24655

London
Desmond Appleby
42 High Street
Harrow-on-the-Hill
Middlesex HA1 3LL,
England

Quad-Eight Electronics
11929 Vose Street
N. Hollywood, California
91605 213 764-1516
Telex 662446

MAGNA-TECH ELECTRONIC CO., INC.

630 Ninth Avenue, New York, N. Y. 10036

Telephone (212) 586-7240

Telex 126191

Cables "Magtech"

Circle 216 on Reader Service Card

www.americanradiohistory.com

Specialist in Telecines and Monitors



1550 B Telecine

*"The
Performer"*

With all new
Encoder/
Enhancer/
Automatic
Differential
Gamma Balance/

FEATURING

Outstanding Colorimetry

- 700-Line Center Resolution
- Two-Level Image Enhancement
- Bias Lighting • Low-Lag Operation
- Automatic Black & White Balance
- Instant Paint • Remote Operation
- Color Comp Variable Masking (optional).

Monochrome Monitors Available Now

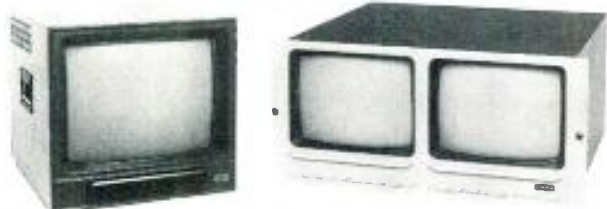

FEATURING AVL* Cohu's exclusive Automatic Video Level*, the feature that makes it possible to maintain a set contrast level independent of signal strength • 800-Line Center Resolution • Back Porch Gated DC Restoration • Differential Input by Jumper Selection • Loop-Through Input • 525/60 U.S. and 625/50 CCIR Scan Rates • Regulated Power Supplies • All Solid-State Circuitry • Continuous Duty Operation • PLUS Plug-in Modularized Circuit Boards that are interchangeable among all models.

*You expect more from Cohu
...and you get it.*



Post Office Box 623
San Diego CA 92112
Phone (714) 277-6700
TWX 910-335-1244

Reps/Dists

Michigan continued

Grand Rapids 49508
616 452-1455
Line: audio & video equip

DAVID ORIENTI
56 S Crestview
Adrian 49221
517 423-5680
Line: audio & RF equip

DAN PRICE
4101 Oak Park Drive SE
Grand Rapids 49508
616 455-5529
Line: video equip

RIELY & PETCHELL SALES
25700 Plymouth Rd
Detroit 48239
313 937-3000
Line: audio components: equip

NORWOOD SCROGGS CO
2221 Arbor Hills Rd
Jackson 49201
517 750-1170
Line: audio components
Tech Labs see ad pg 205

SHALCO INC
23716 Woodward Ave
Pleasant Ridge 48069
313 547-4771
Line: audio products
Telex see ad pg 123

SOUND PRODUCTIONS INC
5929 Schaefer Rd
Dearborn 48126
313 559-8303
Line: audio equip

SOUND SOLUTIONS INC
2791 E 14 Mile Rd
Sterling Heights 48077
313 739-7020
7641 19 Mile Rd
Sterling Heights 48078
Line: audio equip
Haltiainen & Friends see ad pg 122
ADR see ad pg 179
Tweed see ad pg 183

THALNER ELECTRONIC LABS
7235 Jackson Rd
Ann Arbor 48194
313 761-4506
Line: video equip
iSi see ad pgs 52, 97, 180

VF SALES INC
8244 Dear Creek Ln
Canton 48187
313 453-8720
869 South Main
Plymouth 48170
313 453-8720
Line: audio equip
Otari see ad pgs 149, 151, 153
UREI see ad pg 107

THE VIDEO GROUP
77 W Confield
Detroit 48201
313 833-6420
Line: video & lighting equip

WEBSTER & ASSOC
155 Bellarmine Rochester 48063
800 521-2333
Line: broadcasting equip
Alexander see ad pg 104

WKM ASSOC INC
345 Girard
Madison Heights 48071
313 588-2300
Line: test & monitoring instruments

WOLF ASSOC
15843 Seven Mile Rd W

Detroit 48235
313 835-5190
Line: lighting equip

MINNESOTA

AVC SYSTEMS INC
1517 E Lake St
Minneapolis 55406
612 729-8305
Line: broadcast equip
Inovonics see ad pg 116
Orange County see ad pg 176

COZZENS & CUDAHY SALES GROUP
10800 Lyndale Ave S
Minneapolis 55420
612 884-4336
Line: monitoring & test instruments

FM DEY CO
6040 Earle Brown Dr Ste 210-6
Minneapolis 55430
612 560-1095
Line: audio & video equip

ELECTRONIC CENTER INC
127 3rd Ave N
Minneapolis 55401
612 371-5200
Line: audio & video equip

EMMONS ASSOCS. INC
10700 Lyndale Ave
Minneapolis 55420
612 881-1118
Line: full line audio & video equip
CEI see ad pg 105
Conrac see ad pg 39
TFT see ad pg 75

MEL FOSTER CO INC
7389 Bush Lake Rd
Edina 55435
612 835-2252
Line: audio equip

CLARK R GIBB CO
11100 Bren Rd W
Minnetonka 55343
612 932-3859
Line: audio, test equip
Telex see ad pg 123
UREI see ad pg 107

HMR INC
7200 Frances Ave S
Minneapolis 55434
612 920-8200
Line: video equip

INTERNATIONAL COMM
235 Borden Ave
Minneapolis 55405
612 335-6812
Line: video equip

K&M ELECTRONICS
7360 Ohm Lane
Minneapolis 55435
612 835-3080
Line: full line audio & video equip

KODO ASSOC
8100 Penn Ave S
Minneapolis 55431
612 881-1255
Line: video equip
Knox see ad pg 35

KENNETH MEYERS CO
3601 Park Central Blvd
Minneapolis 55416
612 920-7080
Line: audio & test equip
Marconi see ad pgs 63, 93

NATIONAL CAMERA EXCHANGE
9010 Olson Hwy
Minneapolis 55427
612 546-6836
Line: video & camera equip

continued on page 180

Circle 217 on Reader Service Card

SIGNAL PROCESSING FOR BROADCASTING'S NEW PHASE

Original designs from **audio & design recording**



F760X-RS Compex-Limiter

- Separate peak level limiting with
- Multi-ratio variable threshold compressor and noise-reducing low level gain reduction from
- Expander with gating option



E560 Selective Limiter

- ADR unique product
- Band splits with integral, full-function limiter
- Can provide 75 μ S variable pre-emphasis
- Rack mounting and self-powered



F600 Broadcast Limiter

- Stereo/dual mono operation
- Integral power supply
- System bypass on each channel
- 10 μ S - 25mS attack
- 25mS - 3.2 secs and 'auto' release

Contact Nigel Branwell, ADR, P.O. Box 786, Bremerton, WA 98310 (206) 275-5009



**audio &
design
recording**

Circle 218 on Reader Service Card

Providing the international audio industry with clean, quiet, dependable Signal Processing for more than 15 years.

Excellent specs. Exemplary sound. Definitive practicality.

**Creative Flexibility . . .
Great.
Under \$6,000.
Amazing!**

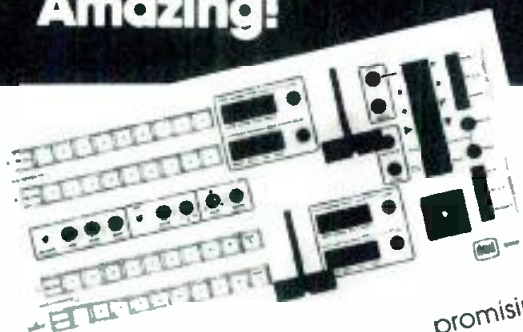

Finally.
An uncommonly
promising switcher

that even the most cost conscious
facility can afford.

Because while we're saving you money we're also
giving you today's most desired production features.
Like two Mix Effects Systems that utilize our exclusive
shared pattern generator. Which enables mix, wipe,
and mix or wipe key (with 'matte' key and key invert)
on each M/E.

And our 'rotate' pot that lets you create hundreds
of standard and special wipes from the seven basic
patterns.

Need adjustable and variable hard, soft, and
bordered edges? It's standard on the 902 along with
pattern modulation, electronic spotlight, positioner,
and preset pattern select.

We don't stop with features, either. With ten tallied
inputs (including blackburst/colorizer), true Mix Effects
re-entry, and separate program and preview output
switching busses the 902 gives you 'big board' flexi-
bility.

Last (but certainly not least!) The 902 carries ISI's
full two (2) year warranty. And, with almost
two hundred units delivered and in the field, one of
the industries best service records.

When you add it all up, it all adds up to 902!
For the name of your nearest authorized ISI Video
Products Distributor call: 800-874-7590 (Toll Free),
904-373-6783 (Florida Only)

(Available in PAL/PAL-M Format October 1, 1979)

**Innovative Switching Ideas
from the people at:
INDUSTRIAL SCIENCES INC**
P.O. BOX 1495
GAINESVILLE, FLORIDA 32602



Circle 219 on Reader Service Card

Reps/Dists

PAUL OHLIN
6004 Olinger Blvd
Mpls 55436
612 929-6924
Line: broadcasting equip
Alexander see ad pg 104

QUANTUM SALES
7710 Computer Ave
Minneapolis 55435
612 831-8583
Line: video & audio components
Tech Labs see ad pg 205

JOHN SCHROEDER CO
1367 Dixon Dr
St Paul Pk 55071
612 459-3636
Line: power supplies

SKOR
1821 University Ave
St Paul 55104
612 645-6461
Line: audio products

SOUND 80, INC
2709 E 25th St
Minneapolis 55406
612 721-6341
Line: audio components, equip
ADR see ad pg 179

TELEX COMMUNICATIONS
9600 Aldrich Ave S
Minneapolis 55420
612 884-4061
Line: audio equip

TODD COMMUNICATIONS INC
7360 Ohms Ln
Minneapolis 55435
612 835-3080
Line: video equip
Digital Video Systems
see ad Cover 3
Echo Science see ad pgs 64-65
Ikegami see ad pgs 53, 158-159

DALE TUCKER
8398 139th Ct
Apple Valley 55124
612 432-7010
Line: broadcast equip
Cetec see ad pgs 31, 173

VIDEO MIDWEST
1907 Hiawatha
Minneapolis 55404
612 338-6825
Line: video & lighting equip
Microtime see ad pg 66

KODO ASSOCIATES, INC
8100 Penn Avenue S
Minneapolis 55431
612 881-1255
Line: audio components, equip
Sound Technology see ad pg 27

MISSISSIPPI

CENTRAL SCHOOL SUPPLY
217 W Capital St
Jackson 39205
601 969-6700
Line: audio & video equip

MISSOURI

BEAMS INC
689 Craig Rd
St Louis 63141
314 649-1060
Line: audio equip

BURNSTERN APPLERY CO
3199 Mercier
Kansas City 64111
816 756-2525
Line: video equip

CALVIN CINEQUIP INC
21 SW Pershing
Kansas City 64108
816 471-7800
Line: full line cine & lighting equip

CENTURIAN MARKETING ASSOC
Box 1011
124 Manchester Rd
314 227-7222
101 E Gregory Blvd
Kansas City 64114
816 333-0303
Line: audio equip
Otari see ad pgs 149, 151, 153

COMMUNITRONICS CORP
1907 S Kingshighway 6d
St Louis 63110
Line: video, transmitting & measuring
equip
Echo Science see ad pgs 64-65

COMMUNICATIONS SYSTEMS
Drawer C
Cape Girardeau 63701
314 334-6097
Line: audio components
Inovonics see ad pg 116

COMMUNITRONICS CORP
1907 S Kings Hwy
St Louis 63110
314 771-7160
Line: video equip
Digital Video Systems see ad Cover 3

**COZZENS & CUDAHY SALES
GROUP**
300 Brooks Dr Ste 100
Hazelwood 63042
314 731-3388
4406 Chouteau Traffic Way
Kansas City 64117
816 454-5836
Line: test & monitoring instruments

DELCOM CORP
2349 Grissom
St Louis 63141
314 432-1164
Line: video equip
ISI see ad pgs 52, 97, 180
Microtime see ad pg 66

DYTEC/SOUTH INC
300 Brookes Dr
Hazelwood 63042
314 721-5400
Line: audio & video equip

FORRISTAL-YOUNG SALES CO INC
7110 Oakland Ave St. Louis 63117
314 645-2361
Line: audio equip

FOX PHOTO PRODUCTS INC
2838 Market St
PO Box 15
St Louis
314 652-1300
Line: full line photo equip

KSW ASSOC
6314 Overton St Ste 202
Kansas City 64133
816 358-5240
Line: audio components

LINES MUSIC CO
Springfield
417 862-5533
Line: audio & video equip

NEVCO
10132 Glenfield Terrace
St Louis 63126
314 843-7406
1715 Baltimore
Kansas City 64108
816 421-1751
Line: audio equip
UREI see ad pg 107

PAC
11920 Grandview Rd
Brandview 64030
816 763-4155
338 Brooks Dr Suite F
Hazelwood 63042

314 731-2331
Line: full line broadcast & test equip
Marconi see ad pgs 63, 93

PACER CORP
7300 Raytown Rd
Raytown 64133
816 358-6638
Line: video equip

RADONICS
4445 Gustine
St Louis 63116
314 481-2222
Line: video equip

TELEVISION ENGINEERING CORP
519 Rudder Rd
Fenton 63026
314 343-5605
Line: broadcast equip
Conrac see ad pg 39
Ikegami see ad pgs 53, 158-159

TRANKLE & ASSOC
310 Baltimore
Kansas City 64108
816 421-1751
Line: audio equip

TV ENGINEERING
519 Rudder Rd
Fenton 63026
314 343-5605
Line: broadcast equip
CEI see ad pg 105

VIDEO MASTERS INC
1820 Wyantotte St
Kansas City 64108
Line: video equip
Echo Science see ad pgs 64-65

MONTANA

HOLM-JAMES DISTRIBUTORS INC
4 Ave S and 6 St
Box 2487
Great Falls 49403
406 761-2420
Line: video equip

NEBRASKA

COLCO SALES
431 S 150 Circle
Omaha 68154
402 333-4709

K&M ELECTRONICS
Omaha
402 551-7600
Line: video equip

McMARTIN INDUSTRIES
4500 S 76 St
Omaha 68127
402 331-2000
Line: professional radio equip.
Inovonics see ad pg 116
UMC see ad pg 14

TODD COMMUNICATIONS INC
120 S 41st St
Omaha 68131
402 551-7600
Line: full line video equip
Digital Video Systems
see ad Cover 3

VIDEO ASSOC INC
324 N 115th St
Omaha 68154
402 333-2288
Line: video equip
Microtime see ad pg 66

NEVADA

ACEY-DECY INC
3049 Rijel Ave
Blvd C-S10

Las Vegas 89102
702 873-3115
Line: lighting equip

CINEMA SERVICES
3050 Sheridan Ct
Las Vegas 89102
702 876-4667
Line: lighting equip

LARR NELSON
6757 Groveview Lane
Las Vegas 89103
702 876-7949
Line: lighting equip

THE VIDEO CENTER INC
4310 Paradise Blvd
Las Vegas 89109
702 732-3201
Line: video equip
Microtime see ad pg 66

NEW HAMPSHIRE

CHURCHILL MILLER
PO Box 333
Londonderry 03053
603 434-0890
Line: video equip

NEW ENGLAND WHLSL. SUPPLY
57 Harvey Rd
Londonderry 03053
603 434-0323
Line: video equip
Microtime see ad pg 66

NEW JERSEY

AF ASSOC
100 Stonehurst Ct
Northvale 07647
201 767-1000
Line: audio & video equip
RTS Systems see ad pg 118

ALEXANDER BATTERY
NE 47 Lenape Dr
Montville 07045
Line: broadcasting equip
Alexander see ad pg 104

BOB CAMERON INC
7 Spruce Pl
Hohorus 07423
201 445-1595
Line: audio equip
Tech Labs see ad pg 205

FLOYD CHURCHILL
PO Box 43
50 Upland Way
Haddonfield 08033
609 429-7871
Line: audio components
Tech Labs see pg 205

CRAFORD COMMUNICATIONS
AC 251 Finlsterre Apts
Lindenworld 08021
609 346-1747
Line: audio & RF equip

COMPREHENSIVE VIDEO SUPPLY CORP
148 Veterans Dr
Northvale 07647
800 526-0242
Line: video, lighting & broadcasting components & hardware

FR DICKINSON JR INC
9 Westinghouse Plaza
Bloomfield 07003
201 429-8996
Line: audio equip
Inovonics see ad pg 116

DYSTRONG INTERNATIONAL
1707 N 76 St
Bergen 07047
201 868-6937
Line: audio & video equip

OUR NEW TURNTABLE IS SENSATIONAL! JUST LIKE THE REST OF THE RUSSCO LINEUP.

• MARK V VARI-SPEED
• FIDELITY / PRO PREAMP
• STUDIO / MASTER 505
• PHONO / MATE PREAMP
• DISCO 421 MIXER
• MM260 AMPLIFIER

Quick-starting, silent turntables now in 3 variable speed models that are causing a sensation with performance minded broadcasters. 5 channel audio mixers that are designed for easy workability by broadcast engineers. A dandy small audio mixer for remotes and home recording. The finest state-of-the-art in phono preamps, speaker and distribution amplifiers. Mono or stereo, we've got the one for you. The bottom line reads like this: At RUSSCO you get rugged reliability and outstanding performance for the lowest possible investment. You can depend on RUSSCO!

• Call Barbara Gaudin for catalog sheets with full specs & prices.

RUSSCO
ELECTRONICS INCORPORATED
5690 E. Shields Ave., Fresno, Calif. 93727
Phone (209) 291-5591

Circle 220 on Reader Service Card

BM E SEPTEMBER, 1979 181

Reps/Dists

New Jersey continued

EMCEE VIDEO SALES

PO Box 2546
1087 Plainfield Ave
201 561-6876
Line: video equip

H M HOLZBERG ASSOCS

PO Box 322
Totowa 07512
201 256-0455
Line full line audio, video, microwave equip

Inovonics see ad pg 116

Logitek see ad pg 188

Orange County see ad pg 176

Utah Scientific see ad pg 60

INTERNATIONAL VISUAL PRODUCTS

333 Rte 46
Fairfield 07006
201 575-6260
Line: video & lighting equip

JOEL & ASSOC

528 River Rd
Teaneck 07666
201 836-8741
Line: audio equip
ADR see ad pg 00
Inovonics see ad pg 116

JOHN KING/DOUG LIGHT

135 Ft Lee Rd
Leonia 07605
201 461-5340
Line: audio & video equip

KOPPE RADEN CORP

10 Stuyvesant Ave
Lyndhurst 07071
201 460-0800
Line: audio & RF equip

LANDY ASSOCS

12 Buxon Rd
Cherry Hill 07003
609 424-4660
1890 E Marlton Pike
Cherry Hill 08003
Line: audio & video equip
Asaca see ad pg 19
Datatek see ad pg 99
Kegami see ad pgs 53, 158-159
Tweed see ad pg 183

L&M ASSOCS

511 Victor St
Saddle Brook 07662
201 843-8700
Line: test instruments
Marconi see ad pgs 63, 93

MJ LODER & SON

1090 Oakland Ave
Plainfoeld 07060
201 668-0860
Line: audio equip
UREI see ad pg 107

OPTIMEDIA SYSTEMS INC

1080 Rte 46
Clifton 07013
201 777-7600
Line: audio & video products
Microtime see ad pg 66

SBM REPRESENTATIVES SALES GROUP

460 Colfax Ave
Clifton 07013
201 7784040
Line: monitoring & tesh instruments

SCIENTIFIC DEVICES

115 Grand Ave
Englewood 07631
201 871-3916
Line: audio & video equip

SHEA SALES

522 Prospect Street
Maplewood 07070

201 762-2382

Line: audio equip, test equip
Sound Technology see ad pg 27

SONNY SIMBERKOFF ASSOCS INC

71 Valley St
S Orange 07079
201 763-7900
Line: audio equip

TELE-MEASUREMENTS INC

Clifton 07014
201 473-8822
Line: video equip
Conrac see ad pg 39

UNITED PAGE INT'L

481 Getty Ave
Paterson 07503
201 279-7500
Line: audio equip

NEW MEXICO

BARNHILL ASSOC INC

1410-D Wyoming NE
Albuquerque 87112
505 299-7658
Line: monitoring & test instruments

CARRULT CUNNINGHAM

PO Box 1697
Taos 87571
505 758-2686
Line: radio equip

DYMA ENGINEERING

PO Box 1697
Taos 87571
Line: full line radio & TV equip

BTX see ad pg 182

CEI see ad pg 105

Digital Video Systems see ad Cover 3

ESE see ad pg 196

ISI see ad pgs 52, 97, 180

LPB see ad pg 167

GC VIDEO

9624 Gutierrez Rd NE
Albuquerque 97111
505 296-5653
Line: audio & videm products, lighting equip

INTEGRATED SYSTEMS INC

133 Jackson St NE
Albuquerque 87108
505 255-8127
Line: video equip

LIGHTING WEST INC

PO Box 30186
Albuquerque 87110
505 266-9830
Line: lighting equip

MAGNETIC MEDIA

222 Truman NE
Albuquerque 87108
505 265-8355

1213 N Lea

Roswell 88201

505 622-6393

Line: video equip

ISI see ad pgs 52, 97, 180

Knox see ad pg 35

Microtime see ad pg 66

MEASUREMENT CONSULTANTS INC

PO Box 951
Las Cruces 88001
505 526-2491

142 Monroe NE

Albuquerque 87108

505 265-6471

Line: test equip

Marconi see ad pgs 63, 93

VIDEO-MONO INC

222 Truman NE
Albuquerque 87108
505 265-8335
Line: video equip

superb time code

4300 Reader and Video Display

4200 Reader and Digital Display

4100 Edit Code Generator

4400 Decoder

BTX guarantees superior SMPTE time code performance from 1.5 to 1,200 IPS at -18 dBm and with any degree of time jitter.

BTX guarantees superb reliability through rigorous engineering design, and assures it with 100-hour production burn-in prior to shipment.

The BTX Corporation 

438 Boston Post Road, Weston, MA 02193 • (617) 891-1239
6255 Sunset Boulevard, Hollywood, CA 90028 • (213) 462-1506

ZEUS INC
310 Val Verde SE
Albuquerque 87108
505 268-3941
Line: audio & video equip

NEW YORK

ASHTON COMMUNICATIONS
140 Glendale Dr
Endicott 13760
607 748-3331
Line: video equip
Microtime see ad pg 66

AMERICAN STAGE LIGHTING
1331-C North Ave
Neq Rochelle 10804
914 636-5538
Line: lighting equip

ARGIL ELECTRONICS LTD
50 W 17 St
New York 10011
212 691-8111
Line: audio & Video equip

AUDIO-VIDEO CORP
55 Delaware Ave
Delmar 12054
518 439-7611
Line: full line of audio/video equip
Digital Video Systems
see ad Cover 3

AURIEMA INT'L GROUP
1 World Trade Center Ste 1829
New York 10048
212 838-0830
Line: audio & video equip

DAVID BAIN ASSOC
11 Orchard Farm Rd
Port Washington 11050
516 883-4818

Line: audio equip, video equip
ESE see ad pg 196
Orange County see ad pg 176

BETTAN SALES INC
77-15 164 St
Flushing 11366
212 591-7600
Line: audio equip

JOE BOTTALI
PO Box 77
Amawalk 10501
914 245-1955
Line: video equip

BOYNTON STUDIO INC
Melody Pines Farm
Morris 13808
607 263-5695
Line: audio & recording equip
Inovonics see ad pg 116

BROWN RADIO SERVICE
250 East Ave
Rochester
716 232-5580
Line: audio components & equip

THE CAMERA MART
456 W 55th St
New York 10019
212 757-6977
Line: full line TV production equip
Echo Science see ad pgs 64-65
Ikegami see ad pgs 53, 158-159
Microtime see ad pg 66

BERNARD DARMSTEDER ASSOC
41 R Oswego St
Baldwinsville 13027
315 638-1216
Line: audio & video equip

DIVERSIFIED LIGHTING SYSTEMS
116 Town Line Rd
PO Box 57
Syracuse 13211
315 455-5811
Line: lighting equip

F&B
CECO INC
315 W 43rd St
New York 10036
212 586-1420
Line: cameras & accessories, lighting equip

FERCO
419 W 54th St
NY 10019
212 581-5474
Line: TV production equip

GBC CORP
74 5th Ave
NY 10018
212 989-4435
Line: video equip

GENERAL CAMERA
471 11th Ave
NY 10018
212 594-8700
Line: TV production equip

B GRIFFITHS
185 Dixon Ave
Amityville 11071
516 842-2300
Line: video equip

GOTHAM AUDIO CORP
741 Washington St
New York 10014
212 741-7411
Line: audio components, test & equip
UREI see ad pg 107

HALSTAN ASSOC
160 New York Ave
N Babylon 11704
516 587-9384
Line: power supplies

HARVEY RADIO
23 West 45th St
212 723-5211

Line: broadcasting equip
Orange County see ad pg 176

LCA SALES
76 Main St
Tuckahoe 10707
212 585-1645
Line: full line broadcast equip
Telex see ad pg 123

LK HANER ASSOCS
7 Susan Lane
Dix Hills 11746
516 427-1114
Line: audio components
Tech Labs see ad pg 205

ITOH AVIATION
270 Park Ave
NY 10017
Line: video equip

OSCAR E KRAUT
530 D Grand St
New York 10002
212 228-5511

KVC INC
770 Lexington Ave
New York 10021
212 752-3690
Line: video equip

L&M
175 W 12th St
212 423-6155
Line: test equip
Marconi see ad pgs 63, 93

LEWIS & DUNNINGAN CO
104 Jamesville Rd
Syracuse 13214
315 446-5522
Line: audio equip
Telex see ad pg 123

Tweed Audio USA.

**If you believe in "Old World Craftsmanship,"
you believe in Tweed Audio!**

Tweed Audio introduces "old world craftsmanship" to products which are all too often mass-produced.

The products of Tweed Audio, Kelso, Scotland, are now available

in the United States.

Built one-by-one by skilled craftsmen, the Tweed Audio line is designed to fill your specific mixing needs.

Based on drama production, film dubbing and recording consoles that are setting the standards in Europe, Tweed Audio USA presents a unique new line of studio consoles. All have exclusive

features, pride of workmanship, a fair price, and prompt delivery.

Ask for details on our standard products, or let us quote you a price on a system customized to your specific needs. Contact Tweed Audio USA, 4545 East Industrial, Suite 5-E, Simi Valley, California 93063. Or call (805) 527-6854.



TWEED AUDIO

Circle 221 on Reader Service Card

Reps/Dists

New York continued

LISTEC TELEVISION EQUIPMENT CORP

35 Cain Drive
Plainview 11803
516 694-8963
Line: video equip

MARTIN AUDIO/VIDEO CORP

423 W 55th
New York 10036
212 541-5900
Line: audio components, equip,
recording accessories
ESE see ad pg 196
Inovonics see ad pg 116
Orange County see ad pg 176

PAUL MILAZZO

230 Mineola Blvd
Mineola 11501
516 248-4858

Line: video equip

MPCS VIDEO INDUST.

514 W 57th St
New York 10019
212 586-3690
Line: broadcast equip
Ikegami see ad pgs 53, 158-159
ISI see ad pgs 52, 97, 180

NET SALES INC

1245 Marsh Rd
Pittsford 14534
716 467-4538
Line: audio components
Tech Labs see ad pg 205

NORTHEAST BROADCAST LABS

15 Charles St
South Glen Falls 12801
518 793-2181
Line: audio RF equip

LPB see ad pg 167
UMC see ad pg 14

PENTAX CORP

Atrium Bldg
98 Cutter Mill Rd
Great Neck 11021
516 487-9800
Line: video equip

PINZ SALES

570 Yonkers Ave
Yonkers 10704
Line: audio equip
Modular Audio see ad pg 187

PROFESSIONAL ELECTRONICS CO

2820 Curry Rd
Schenectady 12303
518 355-3120
Line: audio video products, lighting
equip

JOHN RING & ASSOC

2½ Potter St
Oneonta 13820
607 432-5455
Line: RF equip
Gorman-Redlich see ad pg 193

ALAN SARFATY & ASSOC

83-15 98th St
Woodhaven 11421
212 846-1952
Line: audio equip

SAVAGE SALES

PO Box 95
Fayetteville 13066
315 682-2131
Line: test instruments, equip

SBM REP SALES GROUP

4515 Culver Rd
Rochester 14622
716 266-1400
Line: test & monitoring instruments

F EDWIN SCHMITT CO INC

311 Meacham Avenue

SCIENTIFIC DEVICES

122 Amsden Dr
Rochester 14623
716 334-2445
Line: audio & video equip

SENECA COMMUNICATIONS

112 Killewald St
Tonawanda 14150
716 693-8446
Line: audio & video products

SINGER PRODUCTS CO

One World Trade Center
Suite 2365
New York 10048
212 432-1400
Line: audio components

SONOCRAFT CORP

29 W 36th St
New York 10018
212 760-9300
Line: audio & video equip
Conrac see ad pg 39
**Digital Video Systems
see ad Cover 3**

SOUND SYSTEMS INC

42-12 28th St
Long Island City 11101
212 786-4474
Line: audio & video equip

KEN STARRETT

7723 Third Ave
Brooklyn 11209
212 499-8300
Line: audio & electrical equip

SYRACUSE SCENERY

212 Walton St
Syracuse 13202
315 424-2474
Line: full line of theatrical equip

TECHNISPHERE

215 E 27 St
New York 10016

212 889-9170
Line: full line video equip

TELESCO INT'L SALES CO

#1 Dupont St S
Plainview 11803
516 433-6210
Line: audio components, video equip,
test equip
Ramko see ad pgs 46-47

TELEVISION EQUIPMENT ASSOCIATES

Box 260
South Salem 10590
914 763-8892
Line: full line radio & TV production
equip

THEATRICAL SERVICES & SUPPLIES INC

205C Brook Ave
Deer Park 11729
516 242-5454
Line: audio & stage equip

TESCO ASSOC

2002 Teall Ave
Syracuse 13206
315 463-4566
Line: broadcasting equip
Alexander see ad pg 104

TRI-CHROMA

100 North Rd
White Plains 10603
914 761-8293
Line: audio equip
CEI see ad pg 105
Knox see ad pg 35

UNISTAGE

330 Genessee St
Buffalo 14204
716 853-6500
Line: full line of theatrical equip

Change Sound to Silence with a **TABERASER**



This rugged, heavy duty bulk tape eraser wipes sound from all magnetic tapes, cartridges, cassettes and magnetic film stock; handling up to 2".

It erases with minimum residual noise because the field automatically diminishes at the end of each 30-second cycle.

A thermal control and blower keeps the unit below 71° C.

Available for 60Hz or 50Hz operation.

For the distributor in your area—Call or write:

TABER Manufacturing & Engineering Company
2081 Edison Ave. • San Leandro, Ca. 94577 • (415) 635-3831

Circle 222 on Reader Service Card

The Console That Fits In Your Rack . . . And Your Budget!



**"Versa-Con," 4-mixer
mono audio console
Only \$795**

The 4V50 "Versa-Con" is a rack-mount console perfect for TV, CATV, production and remote broadcast use.

This compact unit features 10 inputs into 4 mixers; balanced-transformer inputs and outputs; cue switches on all mixers; and switchable microphone/high level inputs. You won't find a more versatile small console for the price!

In Stock For Quick Delivery!

For more information on the 4V50, call or write your local Spotmaster distributor, or contact:

**BE BROADCAST
ELECTRONICS INC.**

4100 NORTH 24th STREET • P.O. BOX 3606
QUINCY, IL 62301 • PHONE (217) 224-9600

Circle 223 on Reader Service Card

VIDEO COMPONENTS INC

610 S Main St
Spring Valley 10977
914 356-3700

Line: full line video equip
Sonar Radio see ad pg 186
Video Aids see ad pg 202

VSM LEASING CORP

10815 Bodine Rd
Clarence 14031
716 759-2600

Line: audio equip

WESTEC AUDIO/VIDEO

100 Riverside Dr #5B
New York 10024
212 873-1166

Line: audio components
ESE see ad pg 196

NORTH CAROLINA**BCS ASSOCS**

1310 Beamon Pl
Greensboro 27408
919 273-1918

Line: video & test products

ELECTRONICS MERCHANDISING ENTERPRISE

112 Buena Vista
High Point 27260
919 869-3335

Line: SCA & test equip
Cohu see ad pg 178
NEC see ad pgs 86-87
TFT see ad pg 75

EME

112 Buena Vista
High Point 27260
919 869-3335

Line: video equip
Knox see ad pg 35

A W GREESON JR

219 Homewood Ave
Greensboro 27403

919 292-1791
Line: full line audio & video equip

HAMMOND ELECTRONICS

2923 Pacific Ave
Greensboro 27128

919 275-6391
Line: audio components

JAMES L HIGHSMITH CO

3733 Monroe Rd
Charlotte 28205
704 333-7743

Line: audio & video equip

KIRMAN ELECTRONICS

901 Second St
Winston-Salem 27108

919 722-9131
Line: video equip

LEE ASSOC

PO Box 18833
Raleigh 27609

919 787-5818
Line: test equip
Marconi see ad pgs 63, 93

LONG ENGINEERING CO

961 Burke St
Winston-Salem 27101

919 725-2306
Line: lighting equip

MIDWEST TELE COMMUNICATIONS

4720 Cloverhurst Rd
Winston-Salem 27103

Line: audio, video, lighting equip
Digital Video Systems see ad Cover 3

ISI see ad pgs 52, 97, 180

CARROLL G OGLE

12345 Reserach Triangle Pk
Research Pk 27709

919 544-1140

Line: audio equip

MAITLAND K SMITH INC

5500 Carmel Rd
Charlotte 28211

704 542-1352
Line: audio equip

SOUTHEASTERN SIGHT & SOUND

1717 S Sanders St
Raleigh 27603

919 828-2311
Line: lighting & video equip

SOUTHERN COASTAL MARKETING

10120 Crestwood Dr
Mattens 28105

704 847-5687
Line: audio & video equip
Automated Broadcast Controls see ad pgs 188, 204
Ikegami see ad pgs 53, 158-159
Orange County see ad pg 176
Ramko see ad pgs 46-47

GENE SUDDUTH

PO Box 15263
Charlotte 28210

704 527-2489
Line: video equip

TECHNICAL VIDEO SYSTEMS

245 Executive Pk Blvd
Winston-Salem 27103

919 768-9536
Line: full line audio/video equip
Ikegami see ad pgs 53, 158-159
ISI see ad pgs 52, 97, 180
CEI see ad pg 105

P D THOMPSON

2550 Weymouth Rd
Winston-Salem 27103

919 765-3157
Line: full line broadcast equip
(audio & video)

UNITED ASSOCIATES

Suite 250

One Charlottetown Center

Charlotte 28204
704 334-4776
Line: lighting equip

NORTH DAKOTA**OMF AUDIOVISUAL**

1818 E Broadway
Bismark 58501

701 258-6360
Line: 258-6360
Microtime see ad pg 66

OHIO**A/V MEDIA INC**

6601 Huntley Rd
Columbus 43229

614 272-0014
Line: full line video/audio products
ISI see ad pgs 52, 97, 180

CARRIGHT COMMUNICATIONS

11180 Deerfield Rd
Cincinnati 45242

513 984-4220
Line: video equip
Alexander see ad pg 104

CAVALIER AUDIO VIDEO

6580 Corporate Dr
Cincinnati 45242

513 984-3000
Line: full line audio & video equip

DOUG COOK & ASSOC

2185 Trent Rd
Columbus 43229

614 471-4114
Line: full line broadcast equip
Auto Bdcst Controls see ad pgs 188, 204
Gorman-Redlich see ad pg 193
continued on page 186

Amber 4400A: for the broadcast engineer on the spot.

AMBER 4400A MULTIPURPOSE AUDIO TEST SET.

Designed to provide virtually every test and measurement function you need in a single, sophisticated, integrated instrument. Its performance equals or exceeds competitive equipment, at a fraction of the capital expenditure. The Amber 4400A is a proven product used by station and network engineers around the world.



Use the Amber 4400A with your oscilloscope to plot the frequency response of a cartridge machine or an STL link; measure the weighted noise of a tape recorder.

Plot crosstalk vs frequency or phase response of a stereo system. Speed up proof of performance measurements. The Amber 4400A makes so much of what you do... so much easier.



The Amber 4400A offers versatility and quality. Its features include sine, function, sweep, tone burst and noise generator; autoranging digital dBm meter and frequency counter; multinode filter; spectrum analyzer; frequency response and phase response plotter. High performance; low distortion and high output together with high measurement sensitivity and resolution.

Next to your oscilloscope, perhaps the most powerful test instrument you can own.



Amber Electro Design Ltd.

4810 Jean Talon West
Montreal Canada H4P 2N5
Telephone (514) 735 4105

amber

Export:
Gotham Export Corporation, New York

Circle 224 on Reader Service Card

Remote Control Switcher



SERIES 10

- Signal switching with solid-state reliability
- 10-in by 10-out matrix
- Video, audio, time-code switching
- Remote control via a single coax
- Battery-protected memory and tally contacts standard
- Vertical-interval video switching

DYNAIR

5275 Market St., San Diego, Ca. 92114
Telephone: 714/263-7711
TWX: 910/335-2040

Circle 225 on Reader Service Card

QUALITY TALKS FOR KXL

Portland, Oregon



Continental's 317C is the best measure for any 50 kW AM transmitter purchase. Performance, 125% positive modulation and reserve power capabilities are unbeatable. Today's best sound in 50 kW AM is Continental.

Write for brochure: Continental Electronics Mfg Co. Box 270879 Dallas, Texas 75227 (214) 381-7161

Continental 
Electronics

Circle 226 on Reader Service Card

Reps/Dists

Ohio continued

Orange County see ad pg 176
Ramko see ad pgs 46-47
TFT see ad pg 75

GRINNAN FIXTURE CO

16041 Georgetown St
Minerva 44657
216 862-2323
Line: audio equip & fixtures

ELECTRONIC PRODUCTS CORP

16006 Waterloo
Cleveland 44110
216 692-3050
Line: audio & video equip

IMTECH INC

6862 Engle Rd
Cleveland 44130
216 826-3400
Line: audio equip
Telex see ad pg 123

KLOPF A/V CO

3381 Successful Way
Dayton 45414
513 236-5500
2425 Royalton Rd
N Royalton 44133
216 237-1950
2121 Riverside Dr
Columbus 43221
614 488-5885

Line: full line A/V equip

Conrac see ad pg 39

ESE see ad pg 196

ISI see ad pgs 52, 97, 180

CEI see ad pg 105

Echo Science see ad pgs 64-65

Microtime see ad pg 66

MARLOW ASSOC INC

3645 Warrensville Center Rd
Cleveland 44118
216 881-6500

Line: power supplies

McFADDEN SALES INC

150 E Broad St
Columbus 43215
614 221-3363

Line: audio components, equip

MICRO SALES CORP

34 Virginia Ave
Centerville 45459
513 433-8171
21300 Lorain Rd
Cleveland 44126
216 331-0900

Line: audio & video equip

MIDWEST CORP

1150 C W 8th St
Cincinnati 45203
513 651-1904

Line: broadcast equip

Ikegami see ad pgs 53, 158-159

MIDWEST TELE COMMUNICATIONS

4410 Westerville Rd
Columbus 43229
614 476-2800

Line: full line video equip

Digital Video Systems see ad Cover 3

ISI see ad pgs 52, 97, 180

T R MOORE ASSOC

8513 Springboro Pike
Miamisburg 45342
513 433-0762

Line: test equip

Sound Technology see ad pg 27

OHIO INSTRUMENTS

7180 Brundage Road
Waldo 43356
614 726-2828

Line: test instruments

Marconi see ad pgs 63, 93

J B PARENT CO

4986 Gateway Dr
Medina 44256
216 725-8871

VIDEORASER

RE-USE VIDEOCASSETTES WITH NO LOSS OF QUALITY!

Here's the electronic videocassette eraser for professional and home use. Erases 100 times better than the recorder's internal erase mechanism.

Easy to use.

Erases videocassettes clean... in seconds.

Saves wear on tape and video heads.

Powerful-magnetic flux of 1400 gauss

at 1/4 inch. Less powerful units will not

erase as well.

Backed by Full One Year Warranty.

Contact us today and let us prove it's

the most effective hand-held eraser

available... outperforms comparable units

selling at higher prices.

Your videocassette recorder needs

VIDEORASER... the one the

professionals use.

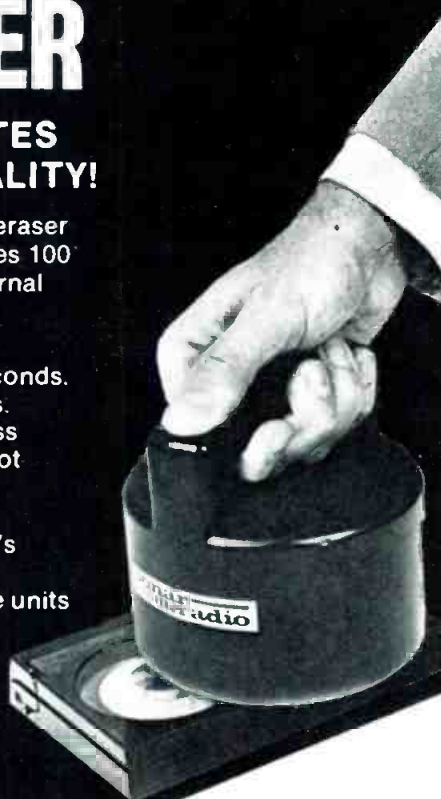

sonar CORP
radio

MODEL VX-1401

3000 Stirling Road Hollywood, Fla. 33021 Tel: (305) 920-5510

Circle 227 on Reader Service Card

Line: audio equip
Otari see ad pgs 149, 151, 153
UREI see ad pg 107

UNITED TRANSFER
PO Box 42272
8095 Village Dr
Cincinnati 45242
513 793-3426
Line: video equip

A C WAHL ASSOCS
PO Box 15220
Cincinnati 45215
513 761-5500
Line: audio components
Tech Labes see ad pg 205

WELLER ELECTRONIC SALES
5274 Sinclair Rd
Columbus 43229
614 885-7819
Line: audio equip

WKM ASSOC INC
16141 Puritas Ave
Cleveland 44135
216 267-0445
7913 S Suburban Rd
Dayton 45459
513 434-7500
Line: lighting & test equip

OKLAHOMA

DOUG BROWN ENTERPRISES
Box 7494
Tulsa 74105
918 747-5045
Line: audio components

DELCOM CORP
6019 S 66 E Ave
Tulsa 74145
918 494-9500
Line: video & lighting equip
Conrac see ad pg 39
ISI see ad pgs 52, 97, 180
Microtime see ad pg 66

HILL RADIO EQUIPMENT
PO Box 622
Claremore 74017
918 341-5240
Line: broadcast equip

MZB & ASSOC
3035 E Skelly Dr Ste 240
Tulsa 74105
918 743-6673
Line: audio equip
Ramko see ad pgs 46-47
TFT see ad pg 75

SYSTEMATICS
510 N Sheridan
Tulsa 74115
Line: video equip

TABCON
PO Box 26
Bixby 74008
918 369-2559
Line: broadcast equip
Inovonics see ad pg 116

OREGON

BCD
7100 SW Hampton St Suite 121
Tigard 97223
503 639-8223
Line: video equip

COLUMBIA TELECOMMUNICATIONS
8656 SE Canyon Rd
Portland 97225
Line: full line audio & video equip

NORTHWESTERN VIDEO INC
237 NE Front Ave
Portland 97204
503 232-4632
Line: full line video equip

Before you settle for an inexpensive but inflexible off-the-shelf console... Or go to the great expense of having one custom designed... look at MAP's new IMPAC™ Series!

Modular Broadcast Consoles... For AM/FM and TV

- Truly outstanding performance specs
- More features
- More flexibility
- Exceptional value — surprisingly affordable
- Readily expandable to meet your growing needs.



This Model 6022, 16 Channel, Dual Output TV Audio Control Center is one of 3 new main frame configurations. Available fully wired. Or in do-it-yourself kit form.



For complete details contact Sales Dept.

MAP MODULAR
AUDIO PRODUCTS
A Unit of Modular Devices, Inc.

50 Orville Drive
Airport International Plaza
Bohemia, N.Y. 11716
(516) 567-9620

Circle 228 on Reader Service Card

Tune In Performance For Your Scully Studio Recorders.

Think Ferrite

10 Times Life • All Track Formats • 100's in Service
Unconditional Warranty.

Ferrite Heads Available for all Professional Recorders.



SAKI MAGNETICS INCORPORATED
(A California Corporation)

577C Uplander Way • Culver City, California 90230 • (213) 649-5983

Circle 229 on Reader Service Card

BME SEPTEMBER, 1979 187

Reps/Dists

Oregon continued

JOHN ODGERS

7150 SW Hampton St Ste 131
Tigard 97223
503 639-8223
Line: video equip

OREGON A/V SYSTEMS INC

117 SW Front Ave
Portland 97204
503 224-4313
Line: audio & video products

SPS ELECTRONICS

9224 SW Fir Grove Ln
Portland 97225
503 297-6919
Line: audio components
Tech Labs see ad pg 205

VIDEOSONICS INC

1412 SE Morrison St
Portland 97214
503 232-4632
Line: video/audio, lighting equip
Digital Video Systems
see ad Cover 3
ISI see ad pgs 52, 97, 180
Microtime see ad pg 66

PENNSYLVANIA

AB&T SALES CORP

1000 Valley Forge Rd
King of Prussia 19406
215 265-2028
Line: audio equip

ALPHA VIDEO & ELECTRONICS CO

9 E Mall Plaza
Carnegie 15106

412 279-6169
Line: video equip
CEI see ad pg 105
Echo Science see ad pgs 64-65

AUDIO INNOVATORS

216 Blvd of the Allies
Pittsburgh 15222
412 471-4777
Line: broadcasting equip
Orange County see ad pg 176

BARTLETT ASSOCIATES INC

130 West Lancaster Ave
Box 72
Wayne 19087
215 688-7325
Line: video equip, switchers
Cohu see ad pg 178

BROADCOM

Tilgham at Jefferson
Allentown 18102
215 437-0607
Line: audio & video equip
Inovonics see ad pg 116

SAM CERCON

30 Sigrid Dr
Carnegie 15106
412 276-7723
Line: video & lighting equip

GEORGE M CONNEEN CO INC

24 S Newtown St Rd
Newtown Square 19073
215 353-2241
Line: audio equip

CONTROL ASSEMBLY CORP

1339 Sylvandell Dr
Pittsburgh 15243
Line: video equip
Knox see ad pg 35

D&H DISTRIBUTING

2525 N 7th St
Philadelphia 19133
717 236-8001

Line: lighting equip

ELMARK CO

2559 Huntingdon Pike
Huntingdon Valley 19006
215 947-0750
Line: audio equip
Sound Technology see ad pg 27

FITE-PETRO INC

400 Bethlehem Pike
Philadelphia 19118
215 248-3171
Line: power supplies

HOLT TECHNICAL SVCS

Ste 205 Westgate Mall
Bethlehem 18017
215 865-3775
Line: broadcast equip
Orange County see ad pg 176
UMC see ad pg 14

KADET PHOTO

1004 Fifth Ave
Pittsburgh 19147
412 261-7258
Line: full line photo equip

KILEY ELECTRIC

319 N Pottstown Pike
Exton 19341
215 363-8550
Line: broadcasting equip
Alexander see ad pg 104

LERRO ELECTRICAL CORP

3125 N Broad St
Philadelphia 19132
215 223-8200
Line: full line video equip
Conrac see ad pg 39
Digital Video Systems
see ad Cover 3
Knox see ad pg 35

L&M ASSOCS

965 A Brostol Pike
Andalusia 19020

Line: test instruments
Marconi see ad pgs 63, 93

LOFSTRUM ELECTRONICS

Empire Bldg
Glassport 15045
412 461-2116
Line: video equip
ISI see ad pgs 52, 97, 180

LPB INC

28 Bacton Hill Rd
Frazer 19355
215 644-1123
Line: audio & video equip
Orange County see ad pg 176
UMC see ad pg 14

SAMUEL K MacDONALD INC

1531 Spruce St
Philadelphia 19102
215 545-1205
Line: audio products

McMANUS ENTERPRISES

139 Montgomery Ave
Bala Cynwyd 19004
215 664-8600
Line: lighting equip

ROBERT MEYERS ASSOC

613 W Cheltenham
Melrose Park 19126
215 224-1663
Line: audio & video equip

MID-ATLANTIC SALES GROUP

1010 W 8 Ave Ste H
King of Prussia 19406
215 265-4040
Line: test & monitoring instruments

CHARLES M NILES & ASSOC

463 W Harvey St
Philadelphia 19177
215 843-4051
Line: power supplies

continued on page 190

If you standardize on Logitek. . . you don't have to standardize!

You can choose from the largest, most diversified, most flexible line of consoles in the industry: more types, more options, more configurations than you can get *anywhere* else, all designed for unsurpassed quality, reliability and performance. Choose up to 24 inputs plus optional EQ, reverb, monitor amps, digital clocks & timers, all at surprisingly low prices!

CALL COLLECT 713-782-4592

for our unbeatable console specs, plus details on our phono amps, monitor amps, timers & much more.



Logitek Electronic Systems, Inc. 3320 BERING DRIVE. HOUSTON. TEXAS 77057

Circle 230 on Reader Service Card

INSTACART®

THROW AWAY YOUR INHIBITIONS!

INSTACART GIVES YOU

INSTANT RANDOM ACCESS
TO ANY OF ITS 48
BROADCAST CARTS



FOR THE ULTIMATE IN FORMAT FLEXIBILITY

Easily interfaced to your existing automation system—ours or "theirs"

4041 HOME ROAD, BELLINGHAM, WA 98225 [206] 733-4567

IGM
A DIVISION OF N.T.I.

Circle 231 on Reader Service Card

THE 24 HOUR CARTRIDGE PLAYER

Automated Broadcast Controls'
2400R Multiple Cartridge Player.



Every hour of every broadcast day, Automated Broadcast Controls' 24 cart Kartel multiple cartridge player combines rugged reliability for your new or updated automation system. Built to military specs, Kartel provides 7 second access to any cart with solid-state switching and standard random tray selection. AVAILABLE FOR IMMEDIATE DELIVERY!

- Senses 4 separate prerecorded cue tones
- Easy interface with any automation system
- Optional record capability

Call Terry Trump or Tom Kitaguchi for timely information. See us at NRBA Booth #500

**automated
broadcast
controls** 1110 Taft Street
Rockville, MD 20850
(301) 762-0558
or (301) 762-1944

Circle 233 on Reader Service Card

GRASS VALLEY GROUP 

400 SERIES ROUTING SYSTEM

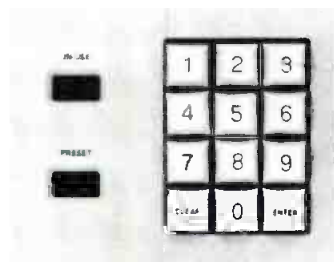
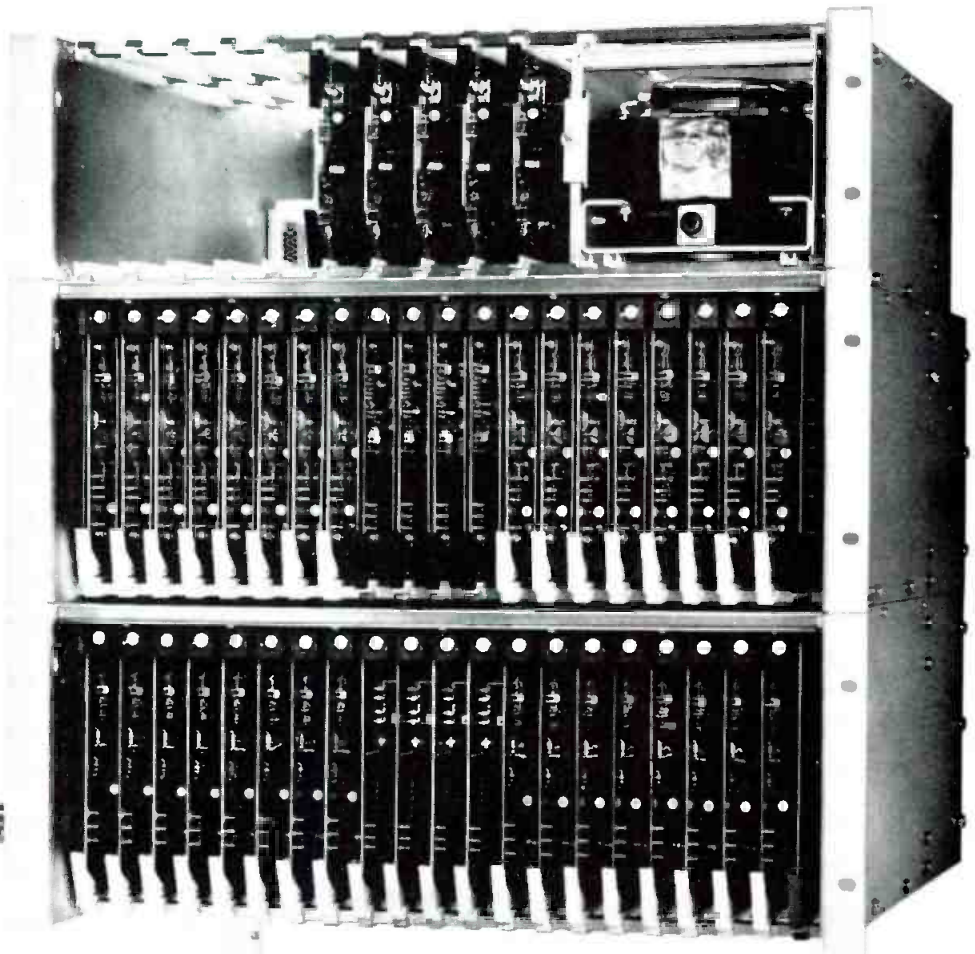
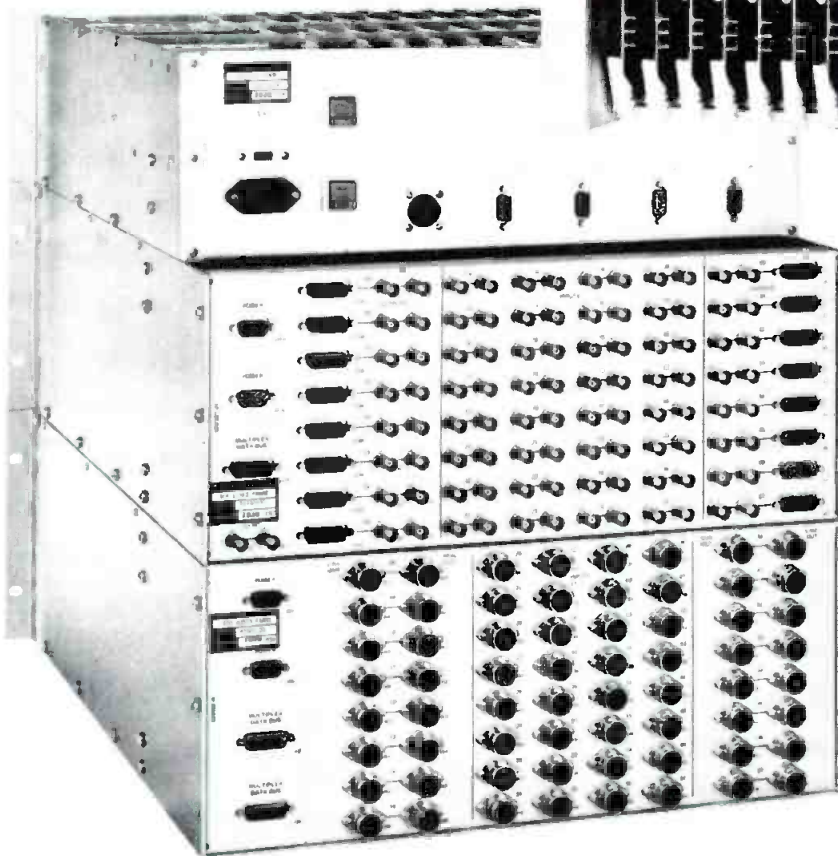

...solves your signal routing problems with world-famous Grass Valley Group quality, and at a remarkably reasonable price!

And the 400 Routing System specifications are unexcelled! For example, the audio section produces +24 dBm into 600 ohms *without* using transformers. And the design of the 400 System is *totally modular*: you

may add to your basic system as needs arise, even adding as little as *one output at a time!* The cost is low, and the quality the highest; Grass Valley Group quality in the new 400 Routing System.

THE GRASS VALLEY GROUP, INC.®

A TEKTRONIX COMPANY

Grass Valley Group Field Offices: WEST: 4419 Van Nuys Blvd Ste 307, Sherman Oaks, CA 91403 (213) 990-6172 • SOUTHEAST: 1644 Tullie Cir NE, Atlanta, GA 33029 (404) 321-4318 • NORTH CENTRAL: 810 W Bristol St, Elkhart, IN 46514 (219) 264-0931 • NEW ENGLAND & MID ATLANTIC: Station Plaza East, Great Neck, NY 11021 (516) 487-1311 • SOUTHWEST: 2639 Walnut Hill Ln Ste 143, Dallas, TX 75229 (214) 358-4229 • MIDWEST: 3585 N Lexington Ave Ste 374, Arden Hills, MN 55112 (612) 483-2594

Circle 223 on Reader Service Card

www.americanradiohistory.com

Reps/Dists

Pennsylvania continued

RICHARD PASS ASSOC

9003 Eastview Rd
Philadelphia 19152
Line: audio equip
Modular Audio see ad pg 187

PEIRCE PHELPS INC

2000 N 59 St
Philadelphia 19131
215 879-7000
Line: full line TV production equip
ADDA see ad pgs 23, 101
CEI see ad pg 105
Conrac see ad pg 39
Ikegami see ad pgs 53, 158-159
ISI see ad pgs 52, 97, 180

MARK PITKOW COMPANY

1580 Buck Hill Dr
Huntington Valley 19006
215 464-8921
Line: audio equip, components

RABAL ASSOC

PO Box 114
Huntingdon Valley 19006
Line: video equip
Echo Science see ad pgs 64-65

RO-CEL ELECTRONICS INC

731 Voice of the Theatre Bldg
Rt 8 North
Pittsburgh 15223
412 781-2326
Line: audio components
ESE see ad pg 196

RPC ELECTRONICS

620 Alpha Drive
Pittsburgh 15238
412 782-3770
Line: full line of audio/video equip
Conrac see ad pg 39

S&S ASSOC

Boro Line Rd
King of Prussia 19406
215 265-3450
Line: test equip
Marconi see ad pgs 63, 93

VAL-TRONICS INC

10 Park Bldg
Pittston 18640
717 655-5937
Line: audio & video equip

VIDEO PRODUCTS

2000 N 59 St
Philadelphia 19131
215 879-7000
Line: video equip

WAGGONER-VERHILL ASSOCS

3550 Laketon Rd
Pittsburgh 15235
412 241-5202
Line: audio components
Tech Labs see ad pg 205

WKM ASSOC INC

90 Clairton Blvd
Pittsburgh 15236
412 892-2953
Line: monitoring & test instruments

RHODE ISLAND

WRH PRODUCTIONS

5 Industrial Way
Riverside 02915
401 333-2070
Line: full line audio components

SOUTH CAROLINA

CALHOUN A/V CO

1234 St Andrews Rd
Columbia 29210

803 772-9130

Line: audio & video products, lighting equip

TECHNICAL INDUSTRIES

1234 St Andrews Rd
Columbia 29210
803 772-9130
Line: video & lighting equip
ISI see ad pgs 52, 97, 180

TENNESSEE

ALLIED SOUND-VISUAL EDUCATION DIV

2741 Nonconnah Blvd S Suite 320
Memphis 38132
901 396-4747
401 Spence Lane
Nashville 37210
615 254-6473
Line: audio & video equip

AUDIO CONSULTANTS INC

1200 Beechwood Ave
Nashville 37212
615 256-6900
Line: audio equip
ADR see ad pg 179

BAKER & TAYLOR EDUCATION PRODUCTS

2910 Craft Dr
Nashville
800 251-8575
Line: video equip

BARRY TRADING CO

105 W Market St
Lebanon 37087
Line: audio components

BROADCAST DISTRIBUTORS

Bible Place
Cleveland 37311
615 472-8200
Line: audio components and equip

Inovonics see ad pg 116

BROADCAST EQUIPMENT & SUPPLY CO

PO Box 3141
Bristol 37620
615 878-2531
Line: full line audio equip
Inovonics see ad pg 116
Russco see ad pg 181

CENTEL SYSTEMS

1444 Shelby Dr
Suite 107
Memphis 38116
901 346-1043
289 Plus Park Blvd
Nashville 37217
615 242-4855
Line: video equip
ISI see ad pgs 52, 97, 180
Microtime see ad pg 66

CREATIVE AUDIO

112 Space Park Drive
Nashville 37217
615 331-3247
Line: broadcasting equip
Orange County see ad pg 176

W R GRACE

Nashville
615 244-5566
Line: video equip

ICC CORP

333-S Troy Circle
Knoxville 37819
615 584-4696
Line: audio & video equip

MO MO MOSELEY

108 Hillsboro
Greenfield 38230
901 235-2943
Line: audio equip
Logitek see ad pg 188

RADFORD ASSOC

1331 Otter Creek Rd

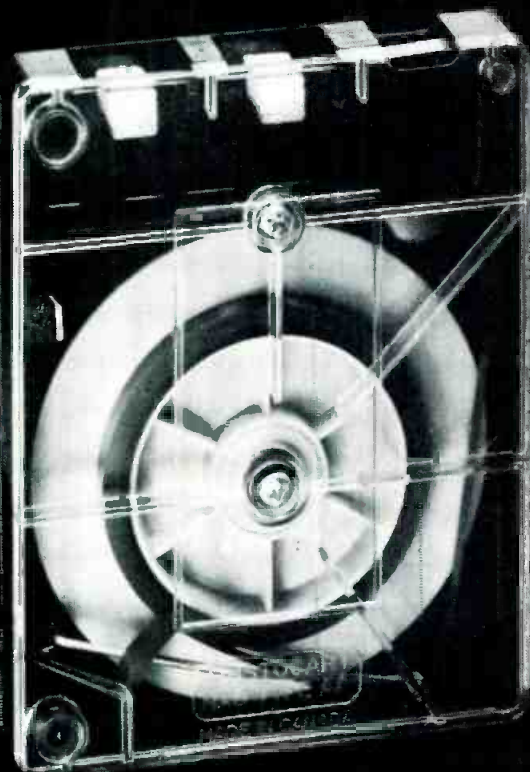

NAB TYPE AA Cartridge
manufactured by
ARISTOCART DIV. WESTERN BROADCASTING LTD.
505 BURRARD ST. VANCOUVER, CANADA V7X 1M6
TEL: (604) 687-2844 TELEX: 04-54639

We've set
the industry's highest standard
of cartridge sound reproduction
— and we maintain it
in every cartridge

With ARISTOCART, quality variation problems and time-consuming selection routines are eliminated. What you tape is what you hear — consistently. Each ARISTOCART is individually tested for phase, frequency response and overall performance. On a properly aligned machine, it will deliver stereo fidelity at least equal to the most sophisticated reel-to-reel equipment. Or we replace it at our expense. Another plus: ARISTOCART's exclusive pressure pad configuration prolongs the life of your expensive head by as much as 100%. So you save significantly on maintenance.

Note to AM operators: ARISTOCART delivers superb mono quality now and incomparable stereo when you convert, without further alteration.

ARISTOCART

The cartridge for people who care how they sound

Circle 234 on Reader Service Card

Nashville 37215
615 373-0231
Line: full line broadcast equip
Asaca see ad pg 19

SPHERE AUDIO SALES
478 Devens Dr
Brentwood 37027
615 794-0155
Line: full line audio equip
BTX see ad pg 182
Saki see ad pg 187

TECHNICAL INDUSTRY
401 Spence La
Nashville 37210
615 256-0800
Line: video equip
ISI see ad pgs 52, 97, 180

TEXAS

ABADON/SUN INC
PO Box 6520
San Antonio 78209
512 824-8781
Line: audio equip
ADR see ad pg 179

ADVANCED SYSTEMS TECHNOLOGY
110 S Collins
Arlington 76010
817 461-4574
Line: audio & video equip

AIREP ELECTRONICS INC
10155 Plano Rd
Dallas 75238
214 349-4360
Line: audio & video equip

ALARM ENGINEERS
2302 Texas Ave
Houston 77003
713 225-9066
Line: audio equip

RTS Systems see ad pg 118

BOB AMOS & ASSOCS
PO Box 3247
Irving 75061
214 827-8232
Line: full line broadcast equip
Sintronic see ad pg 118
UREI see ad pg 107

AUDIO VIDEO ENTERPRISES
7950 Westglen Dr
Houston 77063
713 977-1520
Line: audio & video equip
ISI see ad pgs 52, 97, 180

AUSTIN PROFESSIONAL AUDIO INC
308 W 6 St
Austin 78701
512 477-3706
Line: audio equip

BADEAUX SALES CO
5223 Chantilly Lane
Houston 77092
713 681-9857
Line: power supplies

ARNOLD BARNES ASSOCS INC
1275 Space Pk Dr
Houston 77048
713 488-0814
1300 E Arapaho Rd Ste 107
Richardson 75081
214 235-4543
Line: audio, video, broadcast products
CEI see ad pg 105
Cohu see ad pg 178

BARNHILL TWO INC
111 W Anderson Lane Ste 221
Austin 78752
512 451-0217
1101 Executive Dr E Ste 110
Richardson 75081
217 231-9012
10606 Hempstead Hwy Ste 132
Houston 77092

713 688-9971
Line: test instruments

BESCO INTERNATIONAL
3523 Whitehall Dr.
Dallas 75229
217 630-3600
Line: broadcast equip

BRADENCO
11500 Stemmons
Dallas 75229
214 243-7261
Line: test instruments
Marconi see ad pgs 63, 93

BROADCAST SYSTEMS INC
A103 Smithpark
8222 Jamestown Rd
Austin 78758
512 836-6014
Line: audio equip
Conrac see ad pg 39

CAMPION SALES CO
PO Box 88
Richardson 75080
214 238-8145
Line: audio equip

LEE CAPUT
13620 Littlecrest Dr
Dallas 75234
214 241-0976
Line: video equip

JOHN W CASEY
16776 San Pedro Ave
San Antonio 78216
Line: video equip
Echo Science see ad pgs 64-65

COLLINS RADIO GROUP
1225 North Alma
Richardson 75080
214 690-5000
Line: full line broadcast equip
Inovonics see ad pg 116
Orange County see ad pg 176

Russco see ad pg 181
UMC see ad pg 14

COLLINS CO
10155 Plano Dr Ste 10
Dallas 75228
214 341-7866
3815 Richmond Ave Ste 112
Houston 77027
713 626-1293
Line: audio equip

TOM COPELAND
10523 Maplegrove
Dallas 75218
214 328-4944
Line: broadcast equip
Cetec see ad pgs 31, 173

CROUSE-KINZEY CO
3507 W Vickery Box 9830
Ft Worth 76107
817 737-9911
Line: audio components
LPB see ad pg 167

B CULBERTSON
Suite 1 at the Registry
6350 LBJ Fwy
Dallas 75240
214 387-1389
Line: video equip
Telemet see ad pg 28

VICTOR DUNCAN INC
2659 Fondren Ave
Dallas 75206
214 369-1165
Line: full line TV production equip

ECI
2613 Ross Ave
Dallas 75201
Line: video equip
Echo Science see ad pgs 64-65

TOM FOLSOM
PO Box 16-CC
San Antonio 78201
512 736-1763
Line: video & lighting equip

MICROPROCESSOR REMOTE CONTROL



MODEL MRC-1 SYSTEM FOR BROADCAST AND INDUSTRIAL SERVICE

- MICROPROCESSOR-BASED DESIGN
- MULTI-SITE OPERATION
- AUTO LOGGING OPTION
- KEYBOARD TELEMTRY CALIBRATION

Your remote control project can now utilize today's microprocessor technology. The Moseley Associates' MRC-1 advances broadcast transmitter remote control technology, to match and exceed the facilities of previous dedicated logic and CPU-assisted systems. Full tolerance alarming, user programmable memory, and much more, will revolutionize your thinking about remote control. Contact us now for details.

See us at NRBA Booth 413-15

WRITE FOR OUR
BULLETIN 267
AND OTHER REMOTE
CONTROL BULLETINS

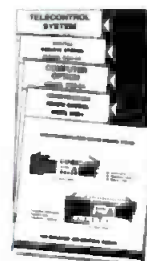

MOSELEY ASSOCIATES, INC.

A FLOW GENERAL COMPANY

SANTA BARBARA RESEARCH PARK, 111 CASTILIAN DRIVE • GOLETA, CA 93017
(805) 968-9621 • CABLE: MOSELEY • TELEX: 658-448



Winsted

STACKED VTRs

For easy
operating
access!



The console holds all sizes of 1/2" VTR equipment. An ideal setup for videotape duplicating. Shelves adjust on 1" increments. Sliding pullout shelves plus caster-mounted mobility for easy maintenance and total access to VTR's. Stack up to 5 VTR drawers on a single console. *For full-line catalog of video consoles, tape and film trucks, film and videotape storage systems, call toll-free or write:*

THE WINSTED CORPORATION 8127 Pleasant Ave So Minneapolis, MN 55420
(612) 888 1957 Toll Free Number (800) 328 2962

Winsted

Circle 235 on Reader Service Card

A NEW APPROACH TO TELECINE LIGHT CONTROL THAT IS . . .

FASTER

QUIETER

SMOOTHER



MODEL 5050
AUTOMATIC LIGHT
CONTROL

and **MORE EFFECTIVE.**

FROM THE WORLD'S LARGEST SUPPLIER
OF TELECINE EQUIPMENT.

LAIRD TELEMEDIA INC.
2125 SOUTH WEST TEMPLE • 801 487 6251
SALT LAKE CITY, UTAH 84115

Circle 236 on Reader Service Card

Reps/Dists

Texas continued

GEISLER BROADCAST SUPPLY
7103 Langdon
Houston 77074
713 998-0847
Line: audio equip
Logitek see ad pg 188

GUARANTEE RADIO SUPPLY
1314 Iturride
512 723-9422
Line: audio equip
Logitek see ad pg 188
Orange County ses ad pg 176

HOOVER BROS INC
2920 Centon St
Sallas 75226
214 741-4527
Line: video equip

INDUSTRIAL AV INC
2617 Bissonnet
Houston 77005
713 524-1956
PO Box 25127
Line: video equip
Conrac see ad pg 39
Echo Science see ad pgs 64-65

JBS ENTERPRISE
7817 Charter Oak Crt
Forth Worth 76179
817 237-4620
Line: broadcasting equip
Alexander see ad pg 104

LINROSE ELECTRONICS
12526 Prima Vista
San Antonio 78233
512 656-6501
Line: audio equip
Logitek see ad pg 188

LITTLE STATE LIGHTING
10507 Harry Hines Blvd.
Dallas 75220
214 352-1659
Line: pighting equip

CHARLES LUCAS SALES CO
PO Box 24632
Dallas 75224
4424 Mint Way
Dallas 75236
214 330-8181
Line: audio equip, test equip
Sound Technology see ad pg 27

LYKES ELECTRONICS
PO Box 26816
Houston 77207
Line: audio & video equip
Dynasciences see ad pg 77

MAGNETIC MEDIA
1314 N Lee
Odessa 79761
915 322-3241
1146 Halm Ste 103
San Antonio 78216
512 349-9313
2211 E Missouri
El Paso 79903
915 533-7205
5555 N Lamar J-115
Austin 78751
512 451-0138
4119 Fleetwood Circle
Amarillo 79109
806352-5932
Line: full line broadcast equip
ISI see ad pgs 52, 97, 180

MARTIN ZIENKOSKY BROWNE & ASSOCS
3801 Kirby, Suite 834
Houston 77006
713 523-4333
13731 Omega Rd
Dallas 75240
214 233-5535
PO Box 9748

Austin 78766
512 454-4371
4203 Beltway
Dallas 75240
16502 Northchase Dr Ste E
Houston 77060
713 448-0881
Line: full line of audio & video equip
IGM/NTI see ad pg 188
Ikegami see ad pgs 53, 158-159
NEC see ad pgs 86-87
TFT see ad pg 75
UMC see ad pg 14

D McLANE
6701 Talmadge Ln
Dallas 75230
214 387-3777
Line: audio equip

MIDWEST TELE COMMUNICATIONS
15046 Beltway Dr
Dallas 75240
214 387-2755
5200 Mitchelldale Ste F28
Houston 77092
713 686-9278
Line: audio, video, lighting equip
Conrac see ad pg 39
Digital Video Systems see ad Cover 3
ISI see ad pgs 52, 97, 180

OWEN ASSOC
PO Box 41109
Lewisville
Line: video equip
Echo Science see ad pgs 64-65

DARRYL PARKER
13731 Omega Rd
Dallas 75240
214 233-5535
Line: radim equip

PROFESSIONAL AUDIO SERVICES
PO Box 1953
Ft Worth 76101
817 536-6254
Line: audio components

**ROCKWELL INTERNATIONAL
(Collins Radio)**
PO Box 10462 M/S 406-106
Dallas 75207
214 996-5424
Line: broadcasting equip
Orange County see ad pg 176

SAVCO
PO Box 427
Richardson 75080
214 234-1841
Line: radio & TV equip
ESE see ad pg 196
Orange County see ad pg 176
Tweed see ad pg 183

JY SCHOONMAKER CO
10710 Sand Hill Rd
Dallas 75238
214 349-1650
Line: tape recorders, audio equip
Telex see ad pg 123

SKAGGS TELECOMM
310 Bearcat Dr
Salt Lake City 84125
801 487-4531
Line: video equip
Microtime see ad pg 66
RTS Systems see ad pg 118

SOUND IDEAS ASSOCS
6123 Spruce Forest
Houston 7708
713 686-4838
5641 Yalei Blvd
Dallas
Line: video equip

**SOUTHWEST AUDIO
CONSULTANTS**
1903 Appollo
Richardson 75081
Line: audio/video equip

SOUTHWEST ELECT
9226 Markville Dr
Dallas 75231
214 690-9881
Line: audio components
Tech Labs see ad pg 205

SUDDUTH MANUFACTURERS REPS

845 39th SE
Paris 75460
214 785-5764
Line: full line video equip
ADDA see ad pgs 23, 101
CEI see ad pg 105
Datatek see ad pg 99
Knox see ad pg 35

V J SYKES ASSOC

1115 S Broadway
Carrollton 75006
214 242-0511
Line: audio & video equip

TENICKE & ASSOC

6432 Westchester
Houston 77005
713 633-6432
Line: audio equip
Otari see ad pgs 149, 151, 153

TEXAS VIDEO SYSTEMS

10209 Plano Rd #3
214 341-1771
2123 Governors Circle W
Houston 77092
713 686-9651
8529 Manderville
Dallas 75231
214 361-9053
9030 Aero
San Antonio 78217
512 824-2311
3602 Slide Rdd Ste B14
Lubbock 79414
806 792-2325
Line: video equip
Microtime see ad pg 66

TOAL ASSOC

2501 Evergreen
Plano 75075
214 596-1315

TOTAL ASSOC

8706 La Brom St
Dallas 75209
214 351-3664
Line: monitors

VIDEO ASSOC

5555 Lamar J 115
Austin 78751
512 451-0138
211 Seventh
Suite 1121 Austin 78701
Line: full line video & lighting equip

VIDEO SYSTEMS

2123 W Governors Circle
Houston 77092
2741 34 St Lubbock 79400
806 792-2325
3817 Ross Ave
Dallas 75204
8801 Tradeway St
San Antonio 78217
Line: full line TV production equip

WEST BROOK AUDIO INC

11836 Judd Court Suite 336
Dallas 75243
214 699-1203
Line: broadcast equip
Orange County see ad pg 176

WESTERN INTL BROADCASTING & ADVERTISING

El Paso Natl Bank Bldg Ste 9K
El Paso 79901
915 533-4937
Line: broadcast equip
UMC see ad pg 14

WHALIN'S PRO AUDIO SALES

2910 Buena Vista
Arlington 76010
817 640-0261
Line: full line audio & recording equip
Inovonics see ad pg 116
Orange County see ad pg 176

WYBORN SALES CO

9450 Skilman #115
Dallas 75243

214 348-9657
Suite #08
7315 Ashcraft
Houston 77036
713 772-0961
Line: audio components, equip

UTAH**BARNHILL TWO INC**

111 W Anderson Lane Ste 221
Austin 78752
512 451-0217
1101 Executive Dr E Ste 110
Richardson 75081
217 231-9012
10606 Hempstead Hwy Ste 132
Houston 77092

BARNHILL THREE INC

54 W 2100 S Ste 3
Salt Lake City 84115
801 485-8121
Line: audio & video test instruments

B.B. ELECTRONIC PRODS

1800 SW Temple
Salt Lake City 84115
801 486-3943
Line: audio equip
Otari see ad pgs 149, 151, 153

JE HALL COMPANY

2330 So Main #8
Salt Lake City 84115
801 486-0151
Line: audio equip
UREI see ad pg 107

RICHARD HUNT

4185 S 300 West
Suite #4
Ogden
801-394-3401
Line: broadcasting equip
Alexander see ad pg 104

INTERMOUNTAIN VIDEO SYSTEM

658 Wilmington Ave
Salt Lake City 84106
801 486-8417
Line: full line lighting & video equip

MEDIA WEST INC

187 West 3100 South Box 458
Bountiful 84010
801 295-3308
Line: audio components & radio equip

PARTRIDGE ELECTRONIC SALES

PO Box 21205
Salt Lake City 84121
801 943-0127
Line: audio test equip, generators

RIA INC

50 East Malvern
Salt Lake City 84100
801 486-8822
Line: broadcast equip
CEI see ad pg 105
Echo Science see ad pgs 64-65
NEC see ad pgs 86-87

SKAGGS TELECOMM SVC

312 Bearcat Dr
Salt Lake City 84125
801 487-4531
Line: broadcast equip
Conrac see ad pg 39
Ikegami see ad pgs 53, 158-159

SOUND ELECTRONICS SERVICES INC

430 S State St
Salt Lake City 84111
801 363-3976
Line: audio equip
Clear-Com see ad pg 166

TV SPECIALISTS

170 E 2100 S
Salt Lake City 84115
801 486-7555
Line: TV production equip
Microtime see ad pg 66

BROADCAST QUALITY WEATHER RECEIVER

Mod. CRW; 162.40, 162.475, 162.55 mhz.



Take advantage of the expanding network of National Weather Service VHF weather stations. This sensitive, selective (and reasonably priced) receiver can bring you accurate local weather, national weather, weather radar data, emergency alert messages, plus farming and marine information where applicable. Its capability for unattended recording of emergency alert messages and updated forecasts can save time and money. Rebroadcast is FCC authorized.

Receiver is rack mountable, remoteable, with an attractive black anodized panel. Demuting and remote alarm are initiated by 1050 "Alert" tone. A relay closure is initiated by either the 1050 tone or a 1650 hz. forecast update signal tone. These are the only tone signals NWS uses.

Crystal and ceramic IF Filters, plus double tuned dual gate MOSFET RF stage, give excellent interference rejection and high sensitivity (.28 microvolts for 12 db. (S+N)/N.). Whip antenna, jack and terminals for external antennas. One year Warranty.

GORMAN-REDLICH • 6 Curtis St. • Athens, OH • 45701
Phone (614) 593-3150

Circle 237 on Reader Service Card

TV Systems Engineer

This career position offers you an opportunity to design custom systems for a variety of VGV customers. The individual chosen will have a solid technical background in television systems with good basic circuit design knowledge.

Field Service Engineer, East Coast

We need an individual to provide after-sales support for our wide variety of complex systems. The position provides travel opportunities within the U.S. plus marketing and engineering career opportunities. An individual with experience designing and/or maintaining television broadcast systems is needed.

Project Engineer

An excellent career opportunity for an individual to assume responsibility for challenging research and development projects. This position requires video project experience plus a BSEE or equivalent.

The Grass Valley Group offers a state-of-the-art technical environment in a serene rural setting. We are located at the foothills of California's Sierra Nevada mountains, where you'll find a relaxed lifestyle and abundant recreational activities.

Interested and qualified individuals are invited to send a resume in confidence to Val R. Marchus, The Grass Valley Group, Inc., P.O. Box 1114, Grass Valley, California 95945. An Equal Opportunity Employer M/F/H.

**The Grass
Valley Group**
A Tektronix Company

Reps/Dists

VIRGINIA

ALPHA AUDIO
2049 W Broad St
Richmond 23220
804 358-3852
Line: full line audio equip
Inovonics see ad pg 116

AVEC ELECTRONICS
2002 Staples Mill Rd
Richmond 23230
804 359-6071
2009 Williamson Rd
Roanoke 24012
703 344-6288
711 Granby St
Norfolk 23510
804 627-3502
Line: video equip
Microtime see ad pg 66

BOB DIX
PO Box 31
Marion 24354
703 783-2001
Line: broadcast equip
Cetec see ad pgs 31, 173

BROADCAST CONSULTANTS CORP
PO Box 590
134 E Market St
Leesburg 22075
703 777-8660
Line: broadcasting equip
Orange County see ad pg 176

DAVID GREENE
21 N Wirt
Leesburg 22075
703 777-8660
Line: audio components & equip
ESE see ad pg 196

Halliakinen & Friends see ad pg 122
Inovonics see ad pg 116
UMC see ad pg 14

GENE HANNA
4618 Cromwell Dr
Annadale 22003
713 941-9025
Line: video & lighting equip

MIDWEST TELE COMMUNICATIONS
1395 Air Rail Ave
Virginia Beach 23455
804 464-6256
Line: audio video & lighting equip
Digital Video Systems
see ad Cover 3
ISI see ad pgs 52, 97, 180
Videotek see ad pg 106

QT ELECTRONICS
7127 Little River Turnpike
Annadale 22003
703 941-4242
Line: video, transmitting & measuring equip

SPHERE ASSOC.
11250-14 Roger Bacon Dr
Reston 22090
703 471-1230
Line: full line audio equip.
BTX see ad pg 182
Saki see ad pg 187

ROBERT SLYE ELECTRONICS
3415 N Washington Blvd
Arlington 22201
703 525-7272
Line: video equip, lighting equip
Conrac see ad pg 39
Microtime see ad pg 66

WASHINGTON

BENNETT ENGINEERING CO
Box 76

Mercer Island 98040
206 232-3550
Line: full line TV production equip
Cohu see ad pg 178
Ikegami see ad pgs 53, 158-159

BROADCAST SUPPLY WEST
2711 Locust Ave W
Tacoma 98466
206 565-2301
Line: broadcast products
Inovonics see ad pg 116
Russco see ad pg 181

790802-3 BME Tape 22 gal. 3 of 3

EARL & BROWN CO INC
PO Box 9285
Seattle 98109
206 284-1121
Line: audio equip

CENTRAL VIDEO
3806 Woodland Pk Ave N
Seattle 98103
206 632-8900
Line: video equip
Microtime see ad pg 66

CUSTOM VIDEO SYSTEMS
1752 15th Ave NE
Seattle 98115
206 524-1026
Line: video & lighting equip
Echo Science see ad pgs 64-65

FLEEHART & SULLIVAN INC
10109 Aurora Ave N
Seattle 98133
206 522-1533
Line: broadcast equip
Knox see ad pg 35
Telex see ad pg 123

FRED HARKNESS
3123 56th St, NW #14

Gig Harbor 98335
206 858-9294
Line: broadcast equip
Cetec see ad pgs 31, 173

ARVA HUDSON
PO Box 1512
Bellevue 98009
206 822-1810
Line: broadcasting equip
Alexander see ad pg 104

IGM/NTI
PO Box 943
Bellingham 98225
206 733-4567
Line: full line audio equip

INSTRUMENT SPECIALIST SALES GROUP
691 Strander Blvd
Seattle 98188
206 575-3765
Line: full line test & monitoring instruments

HENRY JONCAS CO
12058 Lake City Way NE
Seattle 98125
206 363-9200
Line: audio equip, test equip
Sound Technology see ad pg 27

K&M COMMUNICATIONS
1916 NE Ballinger Way
Seattle 98155
206 364-9911
Line: video equip
ISI see ad pgs 52, 97, 180

MARCOM
1916 NE Ballinger Way Ste B
Seattle 98155
206 364-9911
Line: audio equip
TFT see ad pg 75

**When accuracy Counts... Count on Belar
for AM/FM/TV MONITORS**



BELAR
AM MODULATION MONITOR

BELAR CALL ARNO MEYER (215) 687-5550
ELECTRONICS LABORATORY, INC.
LANCASTER AVENUE AT OORSET, DEVON, PA. 19333 • BOX 826 • (215) 687-5550

Circle 238 on Reader Service Card

COLOR SLOW-MOTION DISC RECORDER

- SPORTS
- ANIMATION
- SLIDES

from \$25,000, including TBC/DOC
CCTV versions from \$15,000.

for full specifications:

EiGEN VIDEO P.O. Box 1027, Grass Valley CA 95945 916/273-1341

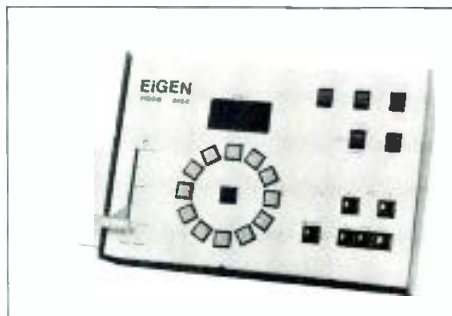

Circle 239 on Reader Service Card

**QUALITY TALKS
FOR
KRGV**
Weslaco, Texas



Continental's new 5/10 kW AM transmitter is setting records for acceptance. It has performance and efficiency, with the cleanest sound around. Listen to Continental: quality talks.

Write for brochure Continental Electronics Mfg. Co Box 270879 Dallas, Texas 75227 (214) 381-7161

Continental Electronics

Circle 240 on Reader Service Card

NORTHSHORE MARKETING (NOR/MARK)
15804 NE 65th St
Redmond 98052
206 453-1628
Line: audio equip
Otari see ad pgs 149, 151, 153
UREI see ad pg 107

NORTHWEST ELECTRONICS
E 730 First Ave
Spokane 99220
509 535-7652
Line: video equip
ISI see ad pgs 52, 97, 180
Microtime see ad pg 66

NORTHWEST INDUSTRIES
5518 Empire Way-S
Seattle 98118
206 725-1400
Line: full line video equip
Conrac see ad pg 39

NUCOM ASSOCIATES
PO Box 243
Edmonds 98020
206 364-9911
Line: video & audio equip
CEI see ad pg 105

PUGET SOUND AUDIO
5105 N 46th St
Tacoma 98407
206 759-4701
Line: broadcasting equip
Orange County see ad pg 176

SCIENTIFIC DEVICES
10843 NE 8 St
Bellevue 98004
206 454-0900
Line: audio & video equip

SCIENTIFIC INSTRUMENTS INC
326 N 100th St
Seattle 98133
206 783-6888
Line: video equip

TASCO
12835 Bellevue-Redmond Rd
Bellevue 98005
206 453-1414
Line: test equip, broadcast equip
Marconi see ad pgs 63, 93

TA TRACK AUDIO
33753 9th Ave So
Federal Way 98003
206 838-4460
Line: audio components
ESE see ad pg 196

WM J WOLFENBARGER
1100 SW Florida St
Seattle 98134
205 522-2522
Line: audio equip

WEST VIRGINIA

MIDWEST TELE COMMUNICATIONS
300 First Ave
Nitro 25143
304 722-2921
Union Bldg 12th flr
Charleston 25321
304 343-8874
Line: full line TV production equip
Digital Video Systems
see ad Cover 3
ISI see ad pgs 52, 97, 180
Microtime see ad pg 66

WISCONSIN

CAMERA CORNER
525 S Military Ave
Green Bay 54303
414 494-1151
Line: video, film, lighting equip

CDP INDUST
801 Hwy 67 — Box 115
Ashippun 53003
414 474-4112
Line: broadcast equip
Asaca see ad pg 19

ELECTRONIC INDUSTRIES INC
19 E Irving Ave
PO Box 266
Oshkosh 54901
414 235-8933
Line: audio equip
Orange County see ad pg 176
Russco see ad pg 181

ELECTRONIC PRODUCTS
PO Box 367
Meguon 53092
414 241-3020
Line: broadcasting equip
Alexander see ad pg 104

K&M ELECTRONICS OF TODD COMM
Professional Bldg Suite 202A
310 N Midvale Rd
Madison 53705
608 238-0271
Line: video equip

KENNETH W MEYERS CO
3055 N Brookfield
Brookfield 53005
414 784-3790
Line: audio & video equip
Marconi see ad pgs 63, 93

ROBERT SHULT
PO Box 115
Ashippun 53003
414 474-4112
Line: audio & video equip

VIDEO IMAGES
12200 W Adler Lane
W Allis 53214

414 475-0111
811 Mayfair Ave
Madison 53714
608 241-5281
Line: full line video equip
Conrac see ad pg 39
ISI see ad pgs 52, 97, 180
Microtime see ad pg 66

VIDEO SYSTEMS
rr #1 Box 235
Lodi 53555
608 592-3272
Line: video equip
Microtime see ad pg 66

CANADA

ADCOM ELECTRONICS LTD
29-16 Connell Court
Toronto, Ont
Line: audio & video equip
Video Aids see ad pg 202

APPLIED ELECTRONICS
299 Evans Ave
Toronto M8Z 1K2
416 252-3761
Bay No 1
4519 12th St NE
Calgary, Alberta
403 277-8600
Line: full line radio & TV equip
Datatek see ad pg 99
Ikegami see ad pgs 53, 158-159

AUVINIC LTD
1280 Lachaine St
St Vincent De Paul Que H7C 2N7
514 661-5120
Line: audio & video equip
Conrac see ad pg 39
Microtime see ad pg 66

Computer Controlled Switcher



SYSTEM 21 SWITCHING

- Route video, audio, data
- 10 x 10 to 1000 x 1000
- Matrix or trunking
- Battery-protected memory
- 100% preset — salvo
- RS-232 computer interface

DYNAIR

5275 Market St., San Diego, Ca. 92114
Telephone: 714/263-7711
TWX: 910/335-2040

Circle 241 on Reader Service Card

FREEZE-FRAME & SLO-MO

"the easy way"

ATHENA 4000 * ATHENA 5000



The Athenas give you
six more features
than the RCA TP-66
or the EK CT-500:
AT LOWER COST!

1. Freeze-frame, instant start/stop, animation, slo-mo—all direct from film to tape by TV film chain.
2. Digital control CMOS circuitry for complete low-voltage remote control and/or computer control.
3. 115V 60 HZ or 220V 50 HZ
4. Modular digital design for easy service.
5. Extended 2-3 year warranty.
6. Insured against obsolescence—retrofitable to new design improvements and options.

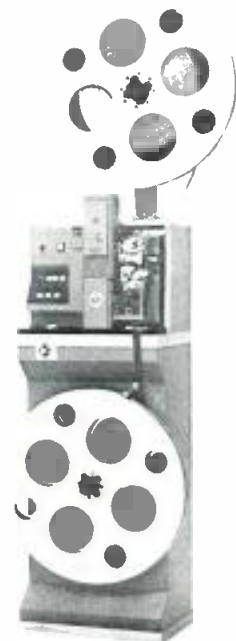

L-W INTERNATIONAL
6416 Variel Avenue
Woodland Hills, CA 91367 U.S.A.
Telephone: 213/348-8614

Circle 242 on Reader Service Card

Perfect Levels

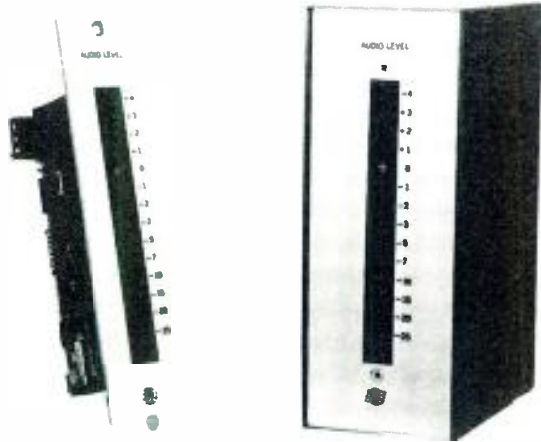

ES 214 Dynamic Audio Level Indicator

made especially for the broadcaster
and recording engineer

Features:

- Peak Audio Levels or Apparent Loudness (Fast Averaging)
- Uses Standard V.U. Scale
- High Brightness, 3-Color Display
- Transformer Isolated Input
- Unregulated "Single-Supply"
- High Input Impedance and Sensitivity
- Low Cost

There are a number of Audio Level Indicators using L.E.D. bar graphs on the market today. Their acceptance is becoming widespread due to obvious advantages. However, the ES 214 gives you more: Transformer Isolated Input others consider too costly; A Power Supply Regulator on the circuit board, so you can use any unregulated D.C. voltage from +15 to +35 while others require dual supplies; The Standard Scale so you don't have to adapt to new numbers; and, the ability to select Peak Responding Mode or a special Fast Averaging Mode to approximate Apparent Loudness.

Get a handle on your levels
with the ES 214

\$105.00



(213) 322-2136

142 SIERRA STREET • EL SEGUNDO, CA 90245

Circle 243 on Reader Service Card

Reps/Dists

CALDWELL A/V EQUIP CO

1080 Bellamy Rd N
Scarborough Ontario
416 438-6230
Line: full line audio & video equip

CAMERATRON COMMUNICATIONS

250 Consumers Rd Ste 806
Willowdale Toronto Ontario M2J 4V6
Line: video equip
CEI see ad pg 105

CANADIAN MARCONI CO

2442 Trenton Ave
Montreal H3P 1Y9 Que
514 341-7630
Line: audio & video equip

CEDAR GROVE SOUND CO

200-11031 Bridgeport Rd
Richmond BC V6X-3A2
Line: broadcast equip
Clear/Com see ad pg 166
Orange County see ad pg 176

COMAD COMMUNICATIONS LTD

91 Kelfield SF Unit 5
Rexdale Ont M9W 5A3
416 245-1734
Line: audio components & video equip
ESE see ad pg 196
Knox see ad pg 35

COMPAC VIDEO SUPPLY CORP

1443 St James St
Winnipeg Manitoba R3H 0W9
204 775-8471
444 Quebec St
Regina Saskatchewan S4R 1K7
Line: video equip
Microtime see ad pg 66

COMSOUND ELECTRONIC LTD

14129 — 130th Ave
Edmonton Alberta T5L 4K8
403 454-4551
Line: video equip
Microtime see ad pg 66

ALAN CRAWFORD ASSOC

800 Windmill Rd
Dartmouth Nova Scotia B3B 1L2
902 469-7865
1330 Marie Victoria Blvd
Longueuil Quebec J4L 1A2
514 670-1212
1299 Richmond Rd
Ottawa Ont K2B 7Y4
613 829-9651
6503 Northam Dr
Mississauga Ont L4V 1J5
416 678-1500
3829 12th St NE
Calgary Alberta T2E 6M5
403 276-9658
116 E 3rd St
N Vancouver BC
604 980-4831
Line: audio components & test equip

CREATIVE HOUSE LTD

Vancouver BC
604 873-5107
Line: audio equip

KELLY DeYONG/STEINTORM

2145 W Broadway
Vancouver BC V6J 1L9
Line: audio & video equip

ESTRON INDUSTRIES LTD

Calgary Abta
403 276-9621
Line: measuring & test equip

GERR ELECTRO ACOUSTICS

365 Adelaide St E
Toronto Ontario
M5A 1N3 Canada
Line: broadcasting equip
Orange County see ad pg 176

GLENTRONIX LTD

160 Duncan Mills Rd
Don Mills Ont M3B 1Z5
416 444-8497
Line: full line audio & video equip
Conrac see ad pg 39

GORDON ENGLISH WESTRONICS

7 W 74th Ave
Vancouver BC
604 872-0636
Line: radio equip

GOULD MARKETING LTD

109 Montec de Liesse
Montreal Quebec H4T 1S9
514 342-4441
Line: audio equip & components
UREI see ad pg 107

J-MAR ELECTRONICS LTD

6 Banigan Drive
Toronto 17 Ont
416 421-9080
Line: audio equip

LASALLE AUDIO

2500 Bates Ste 102
Montreal Que H3S 1A6
514 342-2511
Line: audio equip

LEADER SOUND

195 W 7th Ave
Vancouver BC V5Y 1L8
604 685-6043
Line: audio equip
Tweed see ad pg 183

LUMIVEC

1600 Est Rue Marie-Anne
Montreal Que H2J 2C8
514 525-0616
Line: lighting equip

McCURDY RADIO

108 Carnfurth Rd
Toronto Ont M4A 2L4
416 751-6262
Line: audio tape & accessories

MERITRON LTD

115 St Regis Cr N
Downsview Ontario M3J 1Y9
416 635-9456
Line: audio video equip. components
Conrac see ad pg 39

MSC ELECTRONICS LTD

254 Wildcat Rd
Downsview Ont M3J 2N5
416 661-4180
412 Oakridge Way
Calgary SW Alberta T2V 1T4
403 281-3111
Line: full line broadcast equip
LPB see ad pg 167
TFT see ad pg 75
UMC see ad pg 14

NATIONAL ELECTRONIC

AGENCIES LTD
2137 Commercial Dr
Vancouver BC V5N 4B3
604 253-0811
Line: video equip
Microtime see ad pg 66

NORBEC VIDEO

4315 Girovard
Montreal H4A 3E5
514 481-3483
Line: full line video equip
Digital Video Systems
see ad Cover 3

NORTEC WEST LTD

325 W 5th Ave

Vancouver BC V5Y 1J6
604 872-8525
7056 A Farrell Rd
Calgary Abta T2H 0T2
403 252-8141
Line: audio & video equip
CEI see ad pg 105
Conrac see ad pg 39

OAKWOOD AUDIO LABS LTD
10874 97 St
Edmonton Abta T5H 2M5
403 424-2186
12-1638 Pandosy St
Kelowna BC V1Y 1P5
604 763-5222
654 King Edward St
Winnipeg Manitoba R3H 0P2
204 775-8231
Line: audio equip
Ramko see ad pgs 46-47

RADIO SERVICES INC
2500 Bates Rd
Montreal H3S 1A6
514 342-4503
Line: professional audio & video equip
BTX see ad pg 182
Orange County see ad pg 176

A C SIMMONDS & SONS LTD
975 Dillingham Rd
Pickering Ont L1W 3B2
416 839-8041
Line: audio equip

SMYTH SOUND EQUIP
595 Industrial Park Rd
Longueuil Quebec
514 679-5490
Line: audio equip

SOLID STATE ENGINEERING
Box 355 Sta NDG
Montreal H4A 3P7
514 481-3313
Line: audio & test equip
Tech Labs see ad pg 205

SONO-VIDEO INC
1010 Berlier St
Chomedey Laval
Quebec H7L 3R9
514 667-5861
Line: video equip
Microtime see ad pg 66

TELAKE ELECTRONICS LTD
100 Midwest Rd
Scarborough Ont M1P 3B1
416 752-8575
Line: audio equip
Telex see ad pg 123

TRANSONIC LTD
121 McMaster
Ajax Ont L1S 2E6
416 683-7881
Line: audio equip
Logitek see ad pg 188
Video Aids see ad pg 202

TURNELLE ASSOC LTD
6291 Dorman Rd Unit 17
Mississauga Ont L4V 1H2
416 677-9040
1050 Baxter Rd
Ottawa Ontario K2C 3P1
613 829-8790
721 Progress Ave Unit 1
Kingston Ontario K7M 6S4
613 389-8780
Line: video equip
Microtime see ad pg 66

UNITED VIDEO LTD
1485 Triole St
Ottawa K1B 3S4
613 741-5554
Line: full line video equip
Digital Video Systems
see ad Cover 3

L A VARAH LTD
2077 Alberta St
Vancouver BC
604 873-3211
Line: audio equipment

VIDEO AIDS of CANADA
PO Box 16 Port Credit Station
Mississauga L5G 4L5
Line: video equip
Video Aids see ad pg 202

VIDEO TECHNIQUE INC
1375 Boul Charest West
Quebec G1N 2E7
418 687-5050
Line: full line audio, video,
lighting equip
Digital Video Systems
see ad Cover 3

WATKINS ASSOC
801 York Mills Rd
Don Mills Ont M3B 1X7
416 444-2913
Line: audio & video equip

WESTRONIC ENGINEERING
SALES LTD
7 W 7th Ave
Vancouver BC V5Y 1L4
604 872-0636
Line: audio equip
IGM/NTI see ad pg 188

WILLIAM F WHITE LTD
356 Munster Ave
Toronto M8Z 3C7
416 231-9295
Line: lighting equip

MEXICO

AUDIO PROFESIONALES, SA
Rio Nazas No 26
Desp 8 Mexico 5 DR
535-77-47
Line: audio equip
UMC see ad pg 14

CIRCUITO CERRADO de
TELEVISION
Durango No 243 Desp 202
Mexico 7 DF
514 49-41
Line: video equip

C J CHRISTENSEN SA de CV
Instrumentos Electronicos de Medicion
Melchor Ocampo 150-8
Mexico 4 DF
905 535-2258
Line: full line test & monitoring
instruments

COLOR CASSETTES
Calle America 173
Mexico 21 DF
905 549-3100
Line: video equip
CEI see ad pg 105

PUERTO RICO

BESCO INTERNATIONAL
PO Box 1
Ramey 00604
809 891-1510
Line: test & monitoring equip

HOPE, BENNET & BLACKBURN
18 La Roas
Isia Verde 00913
809 725-8668
Line: full line of radio equip

SAN JUAN ELECTRONICS
154 Ponce DeLeon Ave
San Juan 00906
809 725-3342
Line: lighting equip

JESUS SOTO
PO Box 487
Cagaus 00625
744-3131
Line: radio broadcast equip
UMC see ad pg 14

tube talk

30 mm

P8400 Leddicon®

The new tube
for a
new image.

Here's why . . .

Lag is significantly improved for all channels with the P8400's exclusive variable integral light bias . . . and it's easy to set with the pot and calibrated scale on the base.

Sharper, crisper pictures at all light levels are assured with our new P8400HG tubes (high resolution green) that have 15-20% more depth of modulation.

The best "red" reproduction. The P8400 precision infrared filter cuts off false reds.

Anti microphony double damped mesh . . . only in EEV Leddicons.

Find out how the P8400 Leddicon can improve your image . . . call or write for our Tube Talk brochures.

* Registered Trademark of
EEV Lead Oxide Camera Tubes



At EEV . . . your image
is our business.

EEV, INC.
7 Westchester Plaza, Elmsford, NY 10523, 914-592-6050
EEV CANADA, LTD., Rexdale, Ontario, 416-745-9494
English Electric Valve Co. Ltd., Chelmsford, England
Telex 851-99103

Members of the GEC Group of Companies

Circle 244 on Reader Service Card

BM/E SEPTEMBER, 1979 197

INTERPRETING THE **FCC** RULES & REGULATIONS

Are Your Commercials Legal?

By Frederick W. Ford and Lee G. Lovett; Lovett Ford and Hennessey, P.C., Washington, D.C.

THE AREA OF COMMERCIAL ADVERTISING is one that has presented problems for broadcasters in many instances. The entire area of false, misleading, or deceptive advertising and its regulation has been a sensitive and complex one for both the FCC and the Federal Trade Commission. These two agencies are charged with the supervision of advertising practices. Since two agencies exercise jurisdiction over this issue, it is unclear in many instances where the authority and responsibility for regulating this area lies. In general, the policy of the FCC is (1) not to review the content of alleged deceptive advertising; (2) to refer subjective problems to the FTC, and (3) to take action only in those instances where flagrant violations exist. In addition, the NAB has assumed responsibility for suggesting guidelines for the actions of broadcasters. This article will review the standards set forth by the various bodies responsible for the regulation of advertising.

NAB codes

Realizing that the area of commercial advertising was unclear, the NAB in 1937 voluntarily propounded guidelines regarding commercial advertising and program content. The subscription of broadcasters to the codes adopted by the NAB is purely voluntary. However, subscription to the codes has been high. The adoption of a particular code is done by the Television Code Review Board and ratified by NAB directors.

The primary purpose of the code is to assist subscribing stations in reviewing the legality of the commercials advertised. Questions with respect to specific commercials are raised upon inquiry or complaint of a station's advertisers, advertising agencies, or the public. In addition, a few categories of advertising, including children's toy commercials, are subject to a code pre-clearance.

Although the Code Board adopted certain guidelines, the final determination regarding code compliance is the responsibility of the individual licensee. In order to assist

stations in commercial review, the Code Authority periodically issues Code Board-approved guidelines for particular categories of advertising. The Code Authority publicizes guidelines and changes in, and interpretations of, code policies in a monthly newsletter, *Code News*. The guidelines are then put in a yearly compendium of self-regulating policies and activities.

These guidelines have been of extraordinary help to broadcasters in determining the appropriateness of any particular commercial. Therefore, licensees should apprise themselves of the various guidelines offered by the NAB. In this manner, licensees will be in a position to make a more competent analysis of the appropriateness of any commercial advertising.

Program-length commercials

The Commission has taken the position that certain programs which mix programming and commercial matter are *per se* against the public interest. The FCC views as a "serious dereliction of duty" broadcasting programs which interweave "entertainment" or "informational" content with promotions of the products or services of the program's advertisers.

In making determinations in this area, the licensee should have as a primary consideration the public interest in the program selection. The selection of program matter which appears to be designed primarily for a product of the sponsor rather than to serve the public interest by either entertaining or informing, will raise serious questions as to the licensee's purpose in selecting the program. Just because interested commercial entity sponsors a program the content of which is related to the sponsor's product, however, does not, in and of itself, make the program entirely a commercial.

Broadcasters should remember that one of the key questions to ask is "What is the basis on which the program material was selected?" If a licensee reviews the proposed

QUAD PANEL REFURBISHING SERVICE

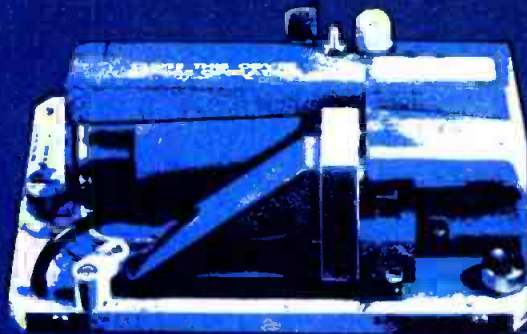

RCA HB and SHB/PT

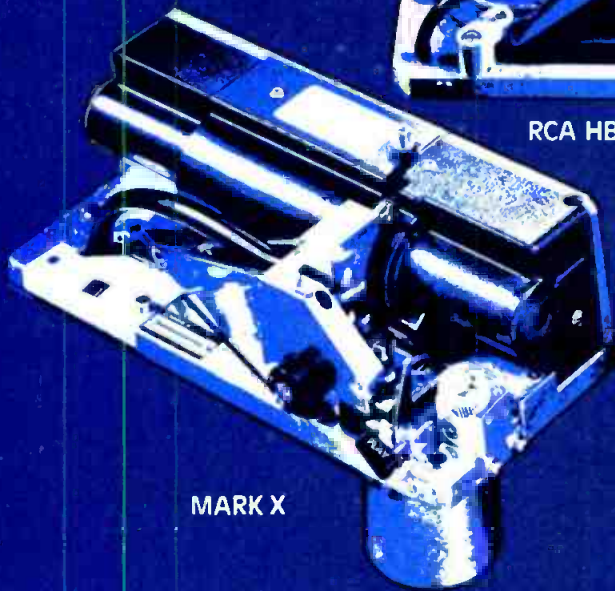

MARK X

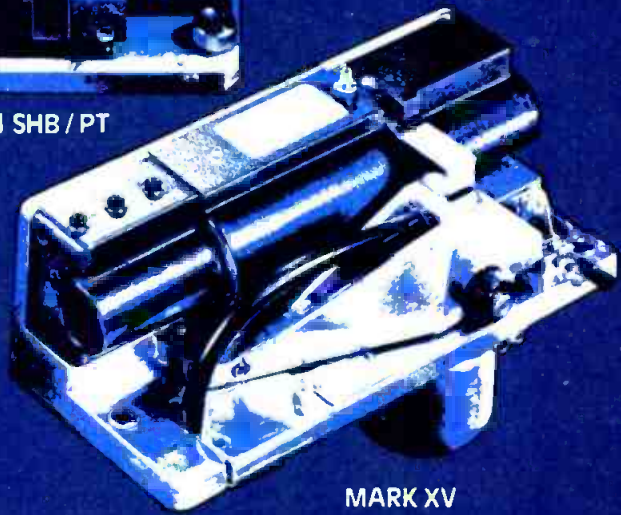

MARK XV

Superior pictures at lower cost! Join the ferrite generation.

Spin Physics will save you 25% to 40% of your costs and give you 2 to 5 times longer life than you receive from ordinary video heads. Get the facts from our full-time field engineer who serves your region.

Superior pictures and significant savings are yours when you specify state-of-the-art high technology hot-pressed ferrite quad video heads from Spin Physics. Bring your quad machines into the new generation — the ferrite generation. The money you save on refurbishing may help toward new generation equipment in some other aspects of your operation. Our steadily growing customer list includes smart operators in all sizes of stations and production centers, and in NTSC, PAL and SECAM standards. You owe it to yourself to compare Spin Physics' advantages.

CALL THE REGIONAL OFFICE FOR YOUR AREA TO SEE THE SPIN PHYSICS STORY IN PERSON

EASTERN: R. Kent White, 301-839-3218
CENTRAL: LeRoy Koonsman, 214-245-1816
SOUTHWEST: Ed Gehle, 805-964-3316
NORTHWEST: Ken Thompson, 415-961-7794

For factory direct information,
contact David Franssens, Video
Products Manager, or Gene Long,
National Sales Manager at 714-453-5410



SPIN PHYSICS, INC.

A KODAK COMPANY

3099 Science Park Road, San Diego, California 92121

Telephone 714-453-5410 Cable SPINEX SANDIEGO TWX 910-322-1737

Circle 245 on Reader Service Card

FCC Rules And Regulations

programming in advance and has made some good faith determinations that the broadcast of the program will serve the public interest, the program will not likely be viewed as a program-length commercial.

In order to avoid any possible question by the FCC, care should be taken to completely separate the program content from the sponsor's sales message. As suggested by the NAB, the following guidelines should be followed by broadcasters:

- Do not use a person in the program content who is identifiable with the sponsor or his product or services.
- Do not use the same person or background in both the program and the commercial segments.
- Do not identify or mention the sponsor's product in the program segment.
- Do not make segments or give descriptions in a commercial segment which contain references to products or services discussed during the program segment.

The area of program-length commercials is one that presents problems for all broadcasters. However, if licensees exercise due diligence in reviewing the content of programs and the associated advertising, broadcasters should not incur needless problems in this area.

Subliminal perception advertising

Subliminal advertising involves the presentation of a statement which is not consciously understood by the viewer. In other words, the viewer does not knowingly register the presentation or the idea as a commercial. The

FCC on several occasions has taken a strong stand against subliminal advertising. In addition, the FCC has referred serious questions in this area to the Federal Trade Commission. Therefore, broadcasters should exercise extreme care to avoid any impropriety. Broadcasters should remember that the FCC has stated that the use of this type of advertising is clearly not in the public interest.

Loud commercials

The FCC has reminded licensees that each station is under an affirmative obligation to take appropriate measures to eliminate the broadcast of an objectionably loud commercial. In the Commission's opinion, licensees should exercise good faith to avoid the presentation of commercials which are too loud. Specific guidelines for regulating the volume of commercials do not exist. Broadcasters should exercise their judgment with respect to whether or not a commercial is indeed too loud and therefore offensive. (See this month's Broadcast Industry News for the FCC's latest action in this area.)

Conclusion

The area of commercial advertising can present a mine field for broadcasters. Therefore, if a broadcaster has a question concerning a particular commercial or program, he/she should not hesitate to contact broadcast counsel immediately. In this manner, broadcasters can significantly reduce the possibility that commercials aired over their systems will run afoul of the rules set forth by the appropriate governing agencies. **BM/E**

MC MARTIN DELIVERS A KNOCKOUT PUNCH!

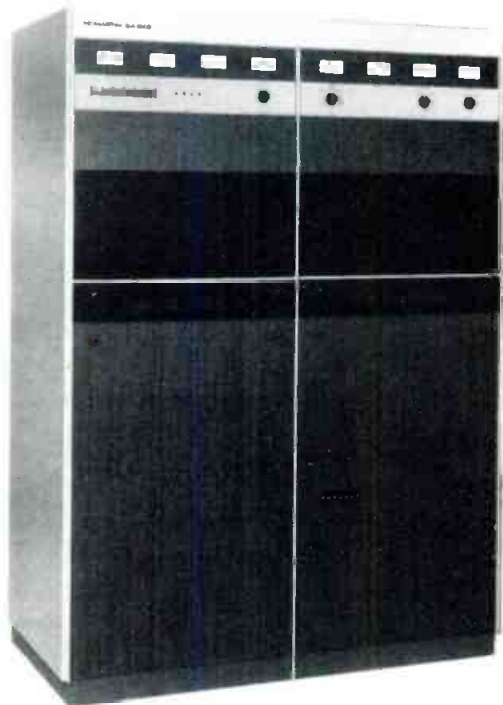

BA-5K2

See it on display — NAB Booth 317

Give your station a lively signal that attracts listeners. Take a look at the new **McMartin BA-5K2** — a 5KW, single ended, three tube AM transmitter based on the design of the highly successful BA-10K ten kilowatt model.

The BA-5K2 features 125% positive modulation capability using a straight-forward plate modulated design providing high performance and reliability at reasonable cost. Other features include a 12 phase power supply, an oil filled modulation transformer, crystal controlled oscillators, LED status indicators, full metering, and cutback power of 2500 or 1000 watts.

McMartin is what you've been looking for.

MC MARTIN • McMartin Industries, Inc. • 4500 S. 76th St. • Omaha, NE 68127 • Phone (402) 331-2000 • Telex 484485
Circle 246 on Reader Service Card

GREAT IDEA CONTEST

VOTE NOW! GREAT IDEA
BALLOT ON READER SERVICE
CARD

21. Master Clock System

Michael J. Cane, Studio Engineer, WFRV-TV, Green Bay, Wisc.

Problem: To create a simple, accurate master clock system utilizing existing standard digital clocks.

Solution: At our station, we have four Heathkit GC-1005 clocks that are used in day-to-day operations. The problems with these clocks is that they are never in synchronization for long due to power line noise.

National Semiconductor has had available for some time the MM 5369 programmable oscillator/divider chip,

commonly used as an internal time base for clocks not utilizing the power line as such. The IC has an internal oscillator which uses a common 3.58 MHz crystal, and through its special dividers delivers 60 Hz. Oscillator use can be negated and driven directly from a stable 3.58 source, the sync generator.

National specifies maximum oscillating frequency at 2 MHz with VDD at 6 Volts, but the IC functions when driven with a VDD of 5 V. If you decide to use a higher VDD, a burst amp may be required and level shift between the IC and following inverter stage will be necessary. In the schematic, the 5369 input is biased at one-half VDD and driven with unterminated subcarrier from a 3.58 DA. The 60 Hz output is applied to an optional "run-hold" switch to facilitate clock setting. This is then routed to a 74LS06 hex inverter that has open collector outputs capable of withstanding 30 V. These outputs are connected to each clock through single conductor shielded cable. Each clock is modified to accept drive from the synchronizer and almost any type of digital clock could be used.

In our case, the alarm function in the Heathkits is not used, so the wires on the alarm display switch were cut away and the switch used for "line-sync" control. Thus the clock can be used on its own power line time base if so desired. An 1/8-inch jack was mounted on the rear for connection to the synchronizer. The foil was cut to the clock LSI timebase input and a 10 K pullup added and wired as in Figure 2.

So far, the system has maintained absolute accuracy and synchronization and is much appreciated by our production department.

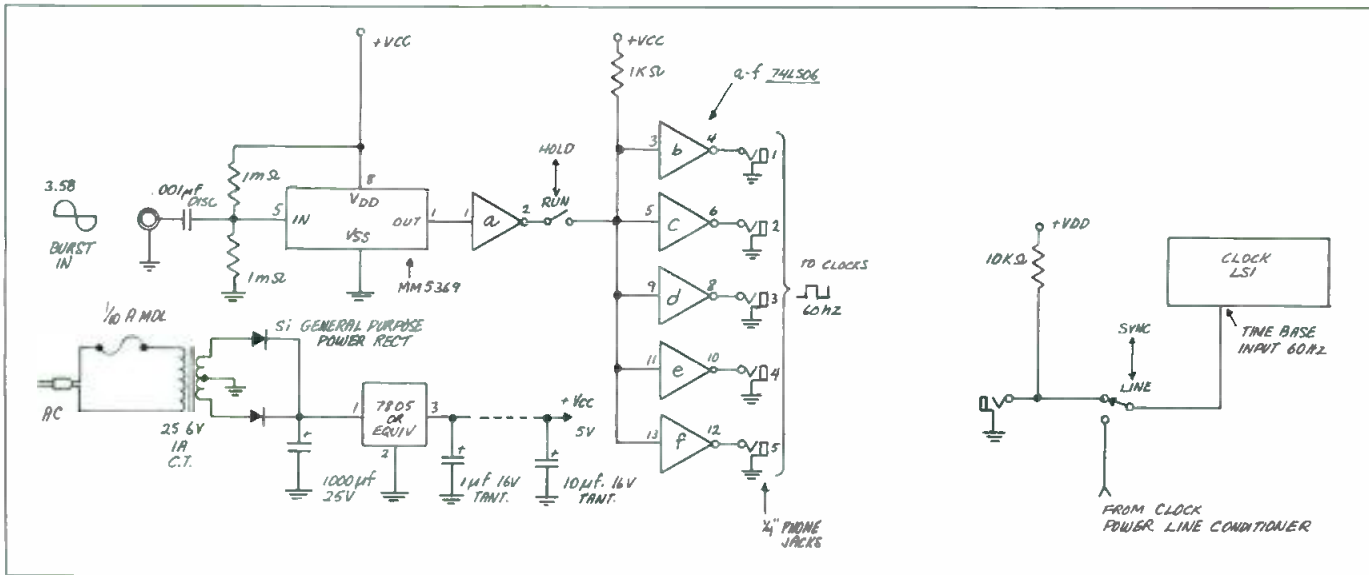

Fig. 1. Cane's master clocks

Fig. 2. Wiring of LSI timebase input and 10K pullup

22. Request Line Warning Light

Michael C. Phillips, WLNC Radio, Laurinburg, N.C.

Problem: To warn announcers that the Request Line is ringing via a 117 V wall lamp.

Solution: We needed a simple, inexpensive, reliable, and noiseless circuit that would allow the announcer in the control room to know when the Request Line was ringing. The ac to the bulb had to be totally isolated from the telephone line, and the circuit had to be constructed so as not to excessively load the line.

The circuit in the schematic completely solves the problems and meets all of the design criteria. The solid state relay is an LED optically coupled to a photosensitive triac and provides at least 1500V isolation. The .47 mfd capacitor drops the 90 V ring voltage to about 5 V at the input to the SSR. (The reactance of the capacitor at 20 Hz [ring frequency] is about 17K.) No filter capacitor is needed since the ring signal is a square, which rectifies virtually into dc. The GE-MOV V130-LA2 is for protection, and is optional. Some of mine have them and some don't. They do not affect the everyday operation. The only difference in the SSRs is the terminals. Also, almost

Narrow your Blanking Widths to meet FCC SPECS..... with VACC's NEW ADJUSTABLE blanking color sync generator.....

Are you having difficulty meeting FCC's public notices 79-10 or 78-423?....they address the maximum legal width of horizontal and vertical blanking intervals. Excessive TV signal blanking widths are of great concern to station licensees, network, program producers and equipment manufacturers. The reason for excessive blanking widths is extensive and complicated. It is fully covered in the March 1979 SMPTE Journal. Simply put, however, after leaving the originating video source, both vertical and horizontal blanking can widen from camera recording to broadcast transmission. This widening can occur from a program during editing, duping, time base corrections and production switching.

Many engineers will innovate to meet these rigid specifications. If you are concerned about blanking widths, consider purchasing VACC's model 5000AB color sync generator. Horizontal blanking periods are adjustable from 8 to 13 microseconds. Vertical blanking can be adjusted from 11 to 22 lines. By narrowing your blanking widths before your system stretches them, you can meet FCC blanking specifications. VACC's model 5000AB is a digitally controlled color sync generator with a six month stability of $\pm 5\text{Hz}$ at 3.579545MHz.

Obtain more information today from your VACC dealer or circle the bingo card. VACC 5000AB \$2145.00.



**VIDEO AIDS corporation
of colorado**

phone USA (303)-667-3301
Canada (800)-261-4088

325 East 7th Street, Loveland, Colorado 80537

Circle 247 on Reader Service Card

Great Ideas

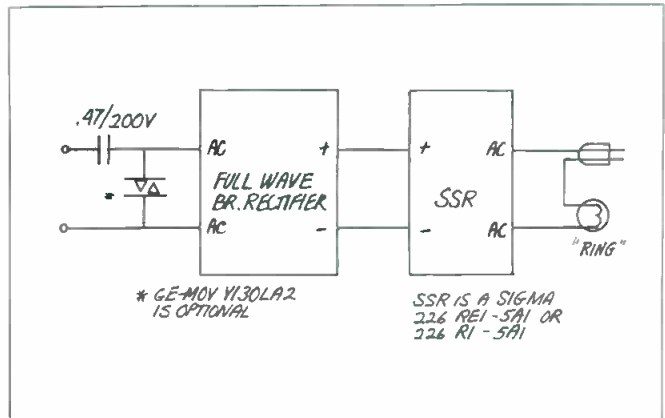

Philips' request line warning light

any SSR will work. You may have to change the value of the capacitor, but that is no problem at all. You will want to add a fuse in series with the ac side of the SSR. I have a bank of lights with a common fuse, since no more than two lights are on at once.

23. Automatic ID Circuit

John Rohwer, Jr., Program Director, WJVM-FM, Sterling, Ill.

Problem: To create a circuit that automatically plays an ID at the top of the hour only.

Solution: Here's our solution to a problem we're sure faces many smaller automated stations. We jingle out of spotsets (with JAM jingles, the world's finest) into music events, and we have a single cart deck devoted to this. We thought, since we got a great screamin' legal ID, wouldn't it be great if the staffers could shove it in once an hour at the end of the newscast and we could go blasting back into music? Well, as could be expected, either someone forgot to play that cart at the top of the hour, or worse yet, it played after each spotset all hour long. While we loved that jingle, we felt possibly some might tire of it quickly. The accompanying circuit has done the trick for a year now.

We have a well-broken-in (some would say ancient) IGM 500 series automation system, which lends itself well to this circuit. The circuit operation is straightforward and reasonably reliable. Our automation master clock sends out a short low-going pulse at the top of the hour.

This low-going pulse fires half of a 556 dual timer IC with the R/C constant wired for a period of, say, 70 seconds, i.e. the total length of our jingle cart. This half of the IC fires K1, through 2n2222 and the 1K current limit. This starts the jingle cart deck (off the air) and keeps it running for at least its total length, unless interrupted by the other circuitry.

From a spare set of contacts on the cart deck's "aux" relay closures, another low-going pulse is provided to the second half of the dual timer. This timer is wired for a time out period of five seconds, and after it's inverted, it provides a low pulse to the 7490 counter's reset O input, thus arming the counter. The same low-going "aux"

continued on page 204

Rules for BM/E's Great Idea Contest

1. Eligibility: All station personnel are eligible. Consultants to the industry may enter if the entry indicates the specific station or stations using the idea or concept. Manufacturers of equipment or their representatives are not eligible.

2. How to Enter: Use the Official Entry Form on this page or simply send *BM/E* a description of your work. State the objective or problem and your solution. Include diagrams, drawings, or glossy photos, as appropriate. Artwork must be legible but need not be directly reproducible and not exceeding three in number. Camera reproducible material is preferred. Length can vary, but should not exceed 500 words. *BM/E* reserves the right to edit material. Entry should include: Name, title, station affiliation, and the class of station — TV, FM, AM. Indicate if idea is completely original with you.

3. Material Accepted for Publication: *BM/E* editors will make all decisions regarding acceptability for publication. If duplicative or similar ideas are received, *BM/E* editors will judge which entry or entries to accept. A \$10 honorarium will be paid for each item published.

4. Voting: Every reader of *BM/E* is entitled to rank the ideas published. This can be done on the Reader Service Card in the magazine or by letters or cards sent to the *BM/E* office. To vote, readers should select the three ideas they like best and rank them 1, 2, or 3.

5. Winners: Top rated entries in the year-long tally will become winners in each of the three major categories (AM, FM, TV). Final winners will be picked in February 1980 and announced in the March 1980 issue of *BM/E*.

6. Prizes and Awards: Three top prizes will be awarded: a programmable electronic calculator will be awarded for the highest rated entry in the respective categories of AM, FM, and TV. Ten

Mail to:

Editors, *BM/E* 1979
 295 Madison Avenue Entry Form
 New York, New York 10017

Name _____ Title _____
 Station Call Letters _____ City _____
 State _____ Zip _____
 Telephone No. _____
 Licensee _____

Class of Station at which idea is used (check one)
 TV _____ FM _____ AM _____

Category: Audio _____ RF _____ Video _____ Control _____

Objective or Problem: (In few words; use separate sheet for details)

Solution: (Use separate sheet—500 words max)

*I assert that, to the best of my knowledge, the idea submitted is original with this station; and I hereby give *BM/E* permission to publish the material.*

Signed _____ Date _____

engineering slide rule calculators will be awarded as secondary prizes for the highest rated entries in the following additional categories (top three winners are not eligible for these prizes): audio (three prizes, one each in the AM, FM and TV categories); RF (three prizes, one each in the categories of AM, FM, TV); Control (three prizes, one each in the AM, FM and TV categories); Video (one prize in TV).

Color Terminal Equipment



SERIES 5900

- Broadcast specifications
- Six-output video, pulse, audio DA's
- Six-output subcarrier and pulse delay DA's
- Color sync generator with optional genlock
- Black burst generator
- Remote control video and audio switching

DYNAIR

5275 Market St., San Diego, Ca. 92114
 Telephone: 714/263-7711
 TWX: 910/335-2040

Circle 248 on Reader Service Card

Professional Sound Systems Start With The Stanton 881S

Stanton Magnetics presents the new 881S Professional Calibration Standard Cartridge. It's the cartridge preferred by recording engineers worldwide and sets a new standard for home audiophiles. Its patented, low mass Stereohedron™ stylus tip makes possible the flawless reproduction of high velocity modulations present on today's finest recordings. The Stanton 881S... where great sound begins. Stanton Magnetics, Terminal Drive, Plainview, NY 11803

STANTON
THE CARTRIDGE OF THE PROFESSIONALS™

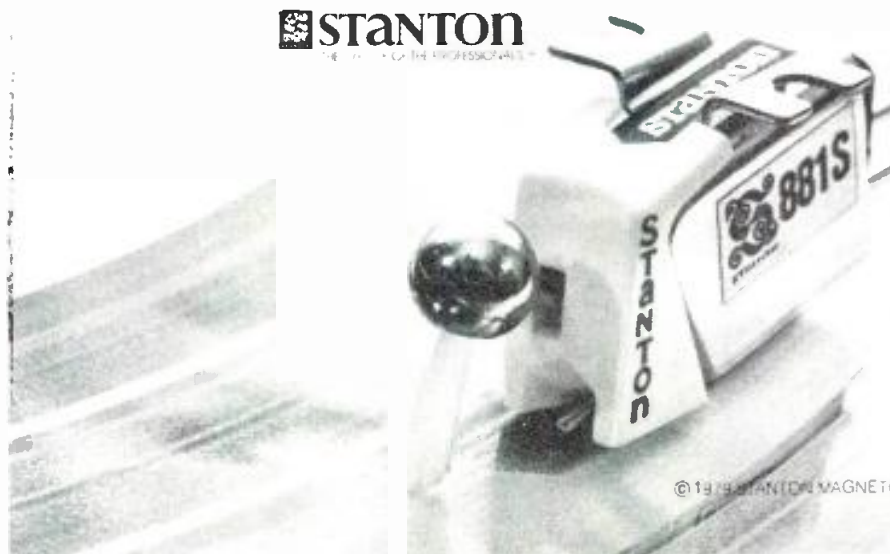

© 1979 STANTON MAGNETICS

Circle 249 on Reader Service Card

Great Ideas

pulses also enter the 7490's count input (which is tied high through 2.2 K just to be convincing). The counter's BCD 1 and 2 output lines are nand-gated to the reset input of the first half of the timer IC as shown.

What it boils down to is this: if during any given hour you plan to break for x number of spotsets, record that number plus one more jingle on the jingle cart (just to be safe). Just before the ID, place three "aux" tones on the tape, then record the legal ID. When the cart is inserted the automation's top-of-the-hour pulse will start the cart and hold it in the run mode until the counter section detects

three "aux" pulses within the five-second timing period) the timer IC is then reset, it relaxes its hold on the cart machine start circuitry, and the cart is allowed to cue to the ID. For the rest of the hour the same cart deck plays regular jingles. At the top of the next hour, the search begins again. Since the circuit reacts only to three "aux" pulses within the five-second timing period, all other "aux" pulses are ignored, and the cart cannot accidentally cue to the wrong cut (if it's properly recorded).

This circuit is ridiculously simple and highly reliable. It's done the job for us for a year, and sure beats wasting another cart deck once an hour. Adaptations and special uses are unlimited and, with the extra reed switch, foul-ups are nil.

Rohwer's automatic ID circuit

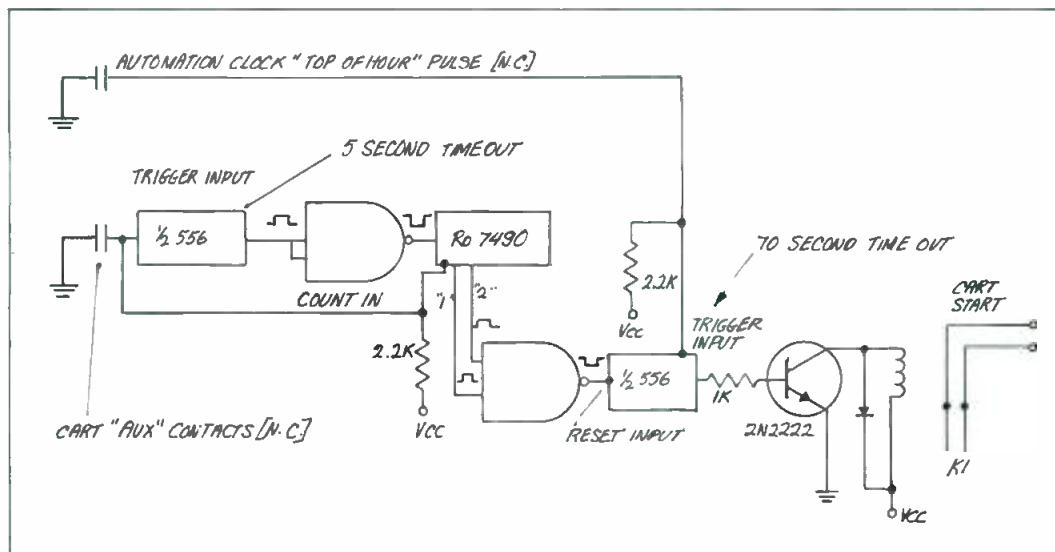

TONE UP YOUR SYSTEM

See us at NRBA Booth #500

**automated
broadcast
controls**

1110 Taft Street
Rockville, MD 20850
(301) 762-0558
or (301) 762-1944

Call Tom Kitaguchi or Terry Trump for more information.

2501G 25 Hz Tone Generator 2501S/2504S Tone Sensors from Automated Broadcast Controls

Building or updating an automation system. Automated Broadcast Controls' 25 Hz Tone Generators and Sensors keep you in control. Each solid-state unit gives you all the flexibility and performance you'll ever need. And all the economy you'll ever want.

2501G
Works from all audio sources
Eliminates bias pops and other noise

2501S
Fixed tone alarm for source switching flexibility
Automatic tape rewind

2504S
Integrated package of four separate modules sense tones
Relay outputs actuate/advance system

Circle 250 on Reader Service Card

TRANSLATORS

VHF - TV

FM

UHF TV

SOLAR POWERED

MICROWAVE FED

SATELLITE FED

ALSO REPAIR PARTS AND UP DATING KITS FOR ALL
ADLER, LITTON AND KEITH ANDERSON TRANSLATORS

Television Technology Corporation

5970 West 60th Avenue • Arvada, Colorado 80003
303-423-1652 / T WX 910-938-0396

Circle 251 on Reader Service Card



Use the N.O.V.A. Block.

A Sapphire Tape
Cleaner.



For all formats
Attaches to
your present
VTR.

Patent Approved

N.O.V.A. Corporation
5801 UPLANDER WAY, CULVER CITY, CA 90230
(213) 641-2046

Circle 252 on Reader Service Card

BROADCAST EQUIPMENT

For more information circle bold face numbers of reader service card.



This month's Broadcast Equipment column highlights some of the equipment introduced at the Eleventh International Television Symposium and Technical Exhibition in Montreux, as designated by the symbol in the upper left corner.

Remote Control System 300



Model MRC-1 is a micro-processor-based remote control system for broadcast transmitters that is designed for multi-site operation. It is capable of utilizing all common radio and/or telephone circuits. Features include random assignment of control functions, telemetry tolerance alarming, cross-functioning channels to allow for indirect power calculation, automatic muting for main/alternate or directional pattern, and elimination of calibration potentiometers through programmable display tracking. The unit performs internal calibration procedures and techniques every four seconds to assure long-term stability and accuracy over a wide temperature range. A system alarm automatically alerts the operator of invalid operational integrity. Optional automatic logging is achieved by adding interface boards and a Model 43 teletype printer. Log headings are stored in long-term solid state memory. Routine operation is via color-coded front panel keyboards. Maintenance/setup is delegated by two levels of built-in security: factory-provided "primary" security code, entered on the front-panel keyboard and allowing access to all primary and secondary setup modes, and a user-generated "secondary" code that allows access to the "limits on/off," "high limit," "low limit," and "site enable" keys. Based on the 6802 μ p chip, the memory board uses EPROMs to establish basic operating architecture. MOSELEY ASSOCIATES, INC.

1 kW FM Transmitter 301



This convection-cooled solid state FM transmitter will handle mono and stereo broadcasts in the 87.5 to 108 MHz range, as well as road-user broadcasts and auxiliary signals with modulation frequencies from 53 to 100 kHz. It

consists of the maker's SU 155 50W broadband exciter linked by a coupling network with two VU 250 500 W amplifiers. By cascading the amplifier stages, transmitter systems for power outputs of between 500 W and 3 KW may be composed. The unit uses a single power supply and self-checking system modules. It can be supplied for active standby, passive standby, or backup on an n/1 principle, depending on user's requirements. 19-inch rack-mounted with space for further plug-ins. ROHDE & SCHWARZ.

Digital Telecine 302



FDL 60 is a digital CCD telecine equipped for all positive and negative 35 mm and 16 mm films. It features line scanning with digital storage, described by the maker as a completely new technique. Film transport is continuous and capstan-driven. Picture information undergoes RGB separation in the prism system and is scanned line after line by CCD sensors before being written into a digital frame store. Forward or reverse operation at normal, slow motion, or fast forward speeds is achieved by modifying the write in and read out program. Full-scale color picture is available at all speeds. Film deck and electronics are controlled by microcomputer. CCD sensors replace pickup or scanning tubes and operate on low voltage dc. They offer long life, no burn-in, afterglow or field lag, continuous vertical scan, and vertically constant resolution. Automatics include color correction (with manual access), shading and fixed pattern noise correction, white level and black level. The frame store employs 16K RAM technology with component coding. Luminance and chrominance information is digitalized separately and stored line-by-line as a full frame. Available options include programmable start, stop and changeover, I/II changeover facility, and interfaces for color correction and editing systems. BOSCH TELEVISION SYSTEMS DIVISION.

EFP Camera Tubes 303



The 74XQ series of 2/3-inch Plubicon tubes are adapted from the XQ1427 ENG tube. Resolution is typically 55 percent at 400 TV lines (uncorrected for

FREE FROM

Tech Labs



INDUSTRY'S MOST COMPLETE
TECHNICAL INFORMATION ON

- ROTARY SWITCHES
- PROGRAMMING SWITCHES
- THUMBWHEEL SWITCHES
- ATTENUATORS

Call or Write For Free Catalog

TECH LABORATORIES, INC

Bergen & Edsall Bldgs., Palisades Park, N.J. 07650
Tel. (201) 944-2221

Circle 253 on Reader Service Card

QUALITY TALKS FOR WAGL

Lancaster, South Carolina



Continental's 317C is the best measure for any 50 kW AM transmitter purchase. Performance, 125% positive modulation and reserve power capabilities are unbeatable. Today's best sound in 50 kW AM is Continental.

Write for brochure: Continental Electronics
Mfg. Co. Box 270879 Dallas, Texas 75227
(214) 381-7161

Continental
Electronics

Circle 254 on Reader Service Card

THE NEW STANDARD

COVERS AM BAND PLUS HARMONICS TO 5 MHz



The Model FIM-41 Field Strength Meter has many more features —

- Measures Harmonics to -80 dB
- High Adjacent Channel Rejection
- Ganged Oscillator/Receiver Tuning
- Stable Operation over wide Temperature Range
- Low Battery Drain Circuits
- Front Panel Speaker
- Large illuminated Meter and Tuning Dial
- Indicates field strength accurately down to 10 μ volts/M
- RF input jack for tuned voltmeter applications

CONTACT US NOW FOR COMPLETE DETAILS ON OUR LINE OF FIELD STRENGTH METERS

POTOMAC INSTRUMENTS

932 PHILADELPHIA AVE.
SILVER SPRING, MARYLAND 20910 (301) 589-2662

Circle 255 on Reader Service Card

TENDEL'S NEW T.U.S.H.* GAGE IS FOR YOUR U-MATIC...

The people who brought you the TENDELOMETER®
NOW proudly present the

* TUS.H. GAGE



The T2-H15-UM TENDELOMETER® Tape Tension Gage shown checking the critical hold-back tension on a Sony 2850. Price \$225 complete.

Write or call for more information; or order direct.

TENDEL
50 Curtner Ave.
Campbell, CA 95008
(408) 377-6588

See us at Video Expo in N.Y. and at the S.M.P.T.E. Show in L.A.

The T.U.S.H. Gage is simply inserted into your U-Matic - the indicators are visible through the cassette window. No need to remove the cassette top chamber to read the indicators.



can determine if the machine needs adjustment.

The T.U.S.H. Gage measures the critical tape reel spindle heights. It is a must to prevent tape damage due to binding. Technical as well as non-technical persons

The T.U.S.H. Gage comes complete with master gage, instructions, and carrying case. Price \$495 complete.

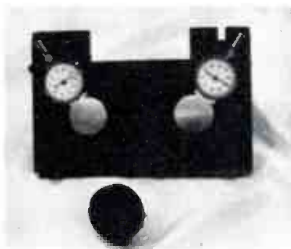

Circle 256 on Reader Service Card

Broadcast Equipment

the lens). The tube has a high beam reserve, according to the manufacturer, and when used with dynamic beam control can provide four f-stops of high-light protection to minimize comet-tailing. Also minimizing comet-tailing and blooming is a diode electron gun for dynamic beam control. A thinner photoconductive target is used for increased resolution. The new tubes, while intended for EFP and studio use, are designed to be suitable for ENG use as well. They are mechanically interchangeable with XQ1427 tubes and have the same pin connections. PHILIPS.

One-Inch Videotape

304



Scotch brand 479 Master Broadcast Videotape is compatible with Ampex, Bosch Fernseh, and Sony one-inch recorders. According to the maker's laboratory tests, RF output and S/N are improved 1 dB over previous tapes and



color noise is improved 2 dB. Coercivity is 740 oersteds, described as generally higher than previous tapes. The tape has a rugged base to permit stop motion, frame-by-frame editing, jogging, and slow motion. Back treatment improves handling and eliminates polyester abrasion, a significant cause of dropouts. A patented cushioned-flange reel provides extra protection for tape edges during use, handling, and shipping. Available in 30, 45, 60, and 90-minute lengths. 3M CO.

Automatic Tester

305



AME775 Automatic Tester is a microprocessor-controlled unit designed for testing electronic crossbar panels. All functional tests — control, modulation paths, transmission loss, leakage, phase error — are carried out on the electronic TELKOS Coupling Panel System within a few minutes. A connected high-speed printer automatically logs each test procedure and prints out test protocols showing input values and results. AEG-TELEFUNKEN.



MODEL 535 DIGITAL COLOR MONOSCOPE SIGNAL GENERATOR

WORLD'S FIRST



- Simple, perfect measurement signal
- Mona Lisa face eliminates the need for the conventional flying spot, and eliminates erroneous color and permits unchanging correct evaluation. This picture does not contain the noise generated by the camera and flying spot
- Y, I, and Q channel characteristics can be measured, once (Model 535N)
- Color resolution can be measured by wedge-shape color signal
- Built in I, Q system broadcasting standards encoder (Model 535N)
- Perfect broadcasting standards encoder of other color systems is also available
- Since the signals are generated electronically, there is no deflection distortion and instability such as that of the conventional camera
- DRC (Digital Rise time Controller) system generates pictures of the same quality as the camera (Applicable to circle, 300 circle, vertical resolution, letters)
- One source generation system assures accurate horizontal resolution
- APC system with constant picture size generates a perfect measurement signal
- Masterpiece that will remain unchanged in the future. This pattern can be selected with confidence
- Plug-in system is extremely easy to service
- The excellence of the conventional digital monoscope signal generator (MODEL 525 series)
- Built-in sync signal generator
- Gen-lock and color lock possible when "L" is appended to the end of the model number
- Grating, flashing-dot and dot are also displayed
- Over-scan scale can be turned ON and OFF
- Mona Lisa face can be changed to the desired reflection (Option 1)
- The Letters "MONA LISA" can be changed to the desired letters (Option 2)



525 SERIES DIGITAL MONOSCOPE SIGNAL GENERATOR

Models 525A12 and 525C12 picture

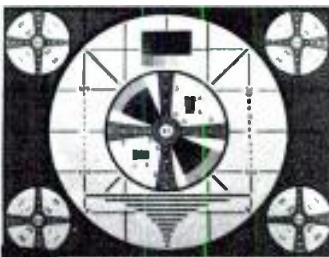

Model 525A11 Picture (Models 525A11H, and 525C11H picture is the same, except for the resolution)

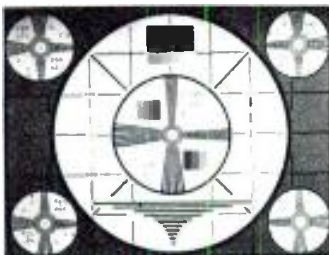

- Since the signal is generated electronically, there is no deflection distortion or instability such as that of the conventional monoscope camera
- DRC (Digital Rise time Control) system generates the same picture quality as a camera
- One-source generation system assure accurate horizontal resolution
- APC system in the same constant picture size generates a perfect measurement signal
- Masterpiece that will not change in the future. You can select this pattern with confidence
- Simple maintenance plug-in unit system
- Same Picture as a conventional monoscope up to letters
- DRC system picture (Applicable to Models A12, C12)
- Checked contrast pattern which is in good reputation
- Built in sync signal generator
- Grating and overscan scale can be turned ON and OFF



NTI America, Inc.

2480 North Yuma Street, Los Angeles, CA 90064
Phone: (213) 441-1100

Broadcast Equipment

12 V Handlamp

306



The Paglight 100 is a 12 V handlamp intended for professional film and television use. The lamphead tilts on the removeable handle for bounce light use; a 1/4-inch screwed bush in the handle base allows stand mounting. The reflector is designed for uniform light distribution. A dichroic filter fits into an optional filter holder and is held in place by a quick-release spring clip; optional four-leaf barndoors also clip onto the filter holder. A spare lamp and fuses may be carried in the handle. Running time with 100 W lamp and 12 V 4 Ah Pagbelt Ni-cad battery pack is 26 minutes; 45 minutes with 7 Ah Pagbelt. Weight of handlamp alone is 0.5 kg; with barndoors and dichroic filter, 0.67 kg. Available as a kit with handlamp, two lamps, three fuses, and 4 Ah Pagbelt in aluminum carrying case. PAG POWER LTD.

Audio Routing System

307

The 410 Series standalone audio routing system has a 32-in/16-out format, expandable to 32-in/64-out or larger without the need for input fan-out distribution amps. Control systems available with the system include pushbutton control panels with illuminated buttons and changeable legends; keypad with preset and program seven-segment

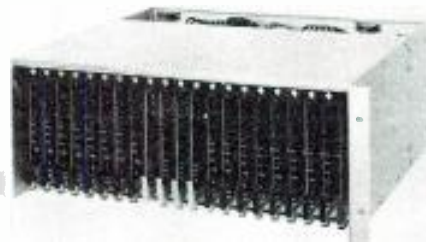

LED readouts in both 19-inch rack and compact formats; desk top keypad panels for executive office or clients' room use; thumbwheel panels with or without readouts in single and multiple configurations; computer interface systems, and X-Y maintenance panels with built-in interrogation capability. The system's control logic is designed to interface with the maker's 400 Series audio-video routing switcher, allowing audio-follow or separate audio control. Multi-channel audio switching using the 400 audio slave matrix provides stereo, or up to seven audio channel operation from one control panel. Specifications include: output program level, + dBm at 600 ohms (+ 30 dBm at

from news



to features



in nothing flat!



lowel omni light.

Lowel-Light Mfg. Inc.
421 W 54th St. N.Y. N.Y. 10019
(212) 245-6744 Telex: 666597UW
West Coast 3407 W Olive Ave
Burbank, Ca 91505
(213) 846-7740



Circle 258 on Reader Service Card

BM/E SEPTEMBER, 1979 207

Circle 257 on Reader Service Card

swintek

The Leading Name In
Cordless Microphone Systems



Transmitters small enough to be hidden almost anywhere, tiny microphones that are so unobtrusive that they probably won't even be noticed, hand-held microphones without the encumbrances of hundreds of feet of wire — that's what cordless microphone systems are all about. But there's one more factor of prime importance — reliability. If you're in television, radio or film and you want a cordless microphone system that not only offers the most advanced state-of-the-art electronics but the highest reliability rating in the industry, Swintek is the answer. There's a Swintek transmitter and receiver to fit your specific needs, no matter what your requirements. Check with us today about the greatest name in cordless microphone systems — Swintek.

alan gordon enterprises inc.

1430 N. Cahuenga Blvd., Hollywood, CA 90028
Telephone: (213) 466-3561 • (213) 988-5590
TWX: 910-321-4526 • Cable: GORDENT

Circle 259 on Reader Service Card

ELECTRO IMPULSE

Thanks You for Making Our
Model DPTC-20KFM Dummy Load
One of our Most Successful Products!



MODEL
DPTC-20KFM
Rated 25KW
DC-110MHz
VSWR 1.15:1

Load is Dry,
Forced Air Cooled,
Fully Interlocked and
**WARRANTED
FOR 25 MONTHS**

Our New General Catalog 890 is now
available upon request covering:

- Dummy Loads • Baluns • Calorimeters
- Power Meters/Attenuators



OUR 29th
YEAR OF
GROWTH

116 Chestnut St., Red Bank, N.J. 07701
Telephone: 201-741-0404

Circle 260 on Reader Service Card

Broadcast Equipment

150 ohms); monitor level, 20 dB below program output; response, 0 to -0.2 dB, 20 Hz to 20 kHz at +24 dBm; distortion, <0.25 percent at +24 dBm (<0.1 percent at +8 dBm); S/N, >90 dB, referenced to -24 dBm, 15 kHz; crosstalk (worst case), >-80 dB at 15 kHz. THE GRASS VALLEY GROUP, INC.

Studio Convertible Camera 308



The SK-96 color camera is a three-tube (2/3-inch Saticons) studio model with an internal head module that can be converted to a hand-held EFP head. The unit features a Triax system that can be plugged into the camera head for operation on coax or Triax at 3000 feet. The Triax system allows all functions to remain at the CCU, including centering, size, width, and linearity of R,G, and B. R,G,B signals are also available for chroma key. 10X zoom lenses are



standard, and 22X lenses may also be used. Automatic white balance, auto iris, color filters, and ND filters are built into the camera. Built-in sync generator is genlocked to external sync signals if black burst or composite video signals are supplied externally. Studio housing is built of aluminum alloy casting to withstand rough handling. Sensitivity is 2000 lux at f/4; S/N is greater than 51 dB; horizontal resolution is 500 lines at center, 400 lines at corners. \$45,000 without lens. HITACHI DENSHI AMERICA, LTD.

Video Editing System 309

The Jatex small-format computerized video editing system is plug-compatible with all video formats having two audio tracks. It uses its own Secne Dex™ four-digit time code, described as a SMPTE-like code that can be set to two, four, or eight-frame resolution. The code is written from and

displayed at the console. It is encoded on a second audio track and is easily erasable or over-dubbed. The unit comes equipped with its own stopwatch timer with large LED displays that show the time up to an hour. The keyboard has 10 digits for edit point selection, access to edit point, and edit rehearsal, with expansion capability for microprocessor-programmed editing. Edit machine control panel is located on the console. Options include end-insert timing, allowing selection of in and out



insert points from two frames to eleven minutes; serial-to-parallel converter for use with the one-inch Type C format; rehearsal feature with slow search for use with machines that have variable speed search; remote control of feed machine; and others. The unit is expandable as user need indicates. Basic system, \$1895. TECHNISPHERE CORP.

VTR Audio Editing Mixer 310

The Audio Box editing mixer is designed to facilitate and expand audio production capabilities of VTR editing systems. It accepts two audio outputs from a playback VTR and delivers two audio lines to record VTR, providing switching and mixing functions that allow either or both lines to be fed to either or both audio inputs of the record VTR. A microphone input and an internal calibration tone can be injected into Audio 1 or Audio 2 input lines. The unit contains a monitoring package consisting of two VU meters and an audio monitor with built-in speaker. This package is also available in a standalone configuration. CEZAR INTERNATIONAL, LTD.

Frequency Counter 311

Model FC-841 is a seven-digit multi-function frequency counter that covers the 10 Hz to 50 MHz range, designed with a tilt-view stand all-steel case and 0.3-inch high LED readout. Supplied with four AA batteries, the unit also operates on ac. Gate time is 100 ms; sensitivity is 30 mV rms up to 30 MHz, decreasing to 60 mV rms at 60MHz. Time base stability is 3 ppm

Off-air TV Demodulator



RX-4B

- High-quality performance
- Optional plug-in front ends VHF, UHF, crystal control
- Optional chopper for video modulation monitoring or closed-loop VIR operation
- For Broadcast, CATV, CCTV use

DYNAIR

5275 Market St., San Diego, Ca. 92114
Telephone: 714/263-7711
TWX: 910/335-2040

Circle 261 on Reader Service Card

BIG DEAL!

Only \$725

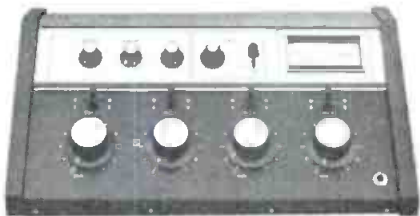

"Mono Four," 4-mixer monaural audio console.

You won't find a better "deal" for the price on smaller monaural consoles than BE's Mono Four. It's perfect for production, on-air, educational or CATV use.

Features include: 2 inputs per mixer; selectable high/low input sensitivity, all channels; individual monitor, headphone and cue amps; and much more.

In Stock For Quick Delivery!

For more information on the 4M50, call or write your local Spotmaster distributor, or contact:

BE BROADCAST ELECTRONICS INC.

4100 NORTH 24th STREET · P.O. BOX 3606
QUINCY, IL 62301 · PHONE (217) 224-9600

Circle 262 on Reader Service Card

Broadcast Equipment



from 68 to 86 degrees F. MHz of kHz ranges are switch-selectable. Supplied with batteries, antenna, and test lead SOAR CORP.

**For more information
circle bold face numbers
on reader service card.**

Motorized Caption Roller 312

The EDS CR2A caption roller features digital IC control of all roll and crawl functions for use in graphics and titling. Speed is continuously variable from 15 to 150 mm/sec. The unit has programmable auto stop capability. Hand-held and desk-mount remote controls are



available, as well as an optional fluorescent lighting system. Construction is of heavy-duty aluminum castings. POWER-OPTICS, INC.

FULFILL YOUR PROFESSIONAL BROADCAST AUDIO EQUIPMENT NEEDS...

AM

FM



• CONSOLES

Standard, Modular & CUSTOM

• COMPONENTS

INTEGRA 3 PC Card System
Rotary-Slider Attenuators

• DISTRIBUTION AMPLIFIERS

• REVERBERTRON 659A

• AUDIO OP-AMP'S & MORE

ENGINEERING, MANUFACTURING & SALES.
PROMPT PROFESSIONAL SERVICE - PLUS!
(Former Fairchild-Robins Equipment Line)

..AT "THE SOURCE"™

For a complete catalog Call or Write Today.
Contact: RICK BELMONT - V.P. Mktg. & Sales

ProTech Audio

PROTECH AUDIO CORPORATION
P.O. BOX 638 • 15 GAIL DRIVE
LAKE RONKONKOMA NY 11779
(516) 473 - 5979

Circle 263 on Reader Service Card

QUALITY TALKS FOR KGNC

Amarillo, Texas



Continental's new 5/10 kW AM transmitter is setting records for acceptance. It has performance and efficiency, with the cleanest sound around. Listen to Continental: quality talks.

Write for brochure: Continental Electronics Mfg. Co. Box 270879 Dallas, Texas 75227 (214) 381-7161

Continental Electronics

Circle 264 on Reader Service Card

BM/E SEPTEMBER, 1979 209

Advertisers' Index

ADDA Corp.	23, 101
Alexander Manufacturing Co.	104
Altec Lansing	147
Amber	185
American Data Corp.	34
Amperex Electronics Corp.	32-33
Ampex Corp.	48
Ampro/Scully	94
Aristocart	190
Arvin/Echo	64-65
Asaca Corp.	19
Audio Designs & Mfg. Inc.	9
Audio & Design Recording Inc.	179
Auditronics	169
Automated Broadcast Controls Inc.	188, 204
Belar Electronics Lab. Inc.	194
Broadcast Audio Associates	141
Broadcast Electronics Inc.	184, 209
Broadcast Video Systems	138
BTX Corp.	182
Burns Audiotechnics	160
Camera Mart	38
Canon USA Inc.	148
Capitol Magnetic Products	79
Central Dynamics Ltd.	43
Cetec	173
Cetec Vega	31
Christie Electric Corp.	92
Chyron Corp.	171
Cinema Products Corp.	129
Clear-Com Intercom Systems	166
CMC Tech.	24-25
CMX Systems	17
Cohu Inc.	178
Colorado Video	135
Commercial Electronics Inc.	105
Comrex Corp.	120, 121
Conrac Corp.	39
Consolidated Electronics Industries	30
Consolidated Video Systems	131
Continental Electronics Mfg. Co.	186, 194, 205, 209
Convergence Corp.	133
CSI Electronics Inc.	100
Datametrics Inc.	154
Datek	99
Datatron, Inc.	21
Digital Video Systems	C3
Dolby	150
Dyma Engineering	26
Dynair Electronics	186, 195, 203, 209
Dynasciences	77
Eastman Kodak Co.	124-125

EEV Inc.	197
EG & G	96
Eigen Video	194
Eimac, Div. Varian	29
Electro Impulse	208
Electro-Voice Inc.	143
ESE	196
Fidelipac	18, 134
Frezzolini Electronics Inc.	170
Fuji Photo Film	175
General Electric Co. Video Display Equipment	145
Alan Gordon Enterprises Inc.	208
Gorman-Redlich Mfg. Inc.	193
Grass Valley Group	7, 22, 189
Hallikainen & Friends	122
Harris Corp.	12
Hitachi Denshi American Ltd.	11
Ikegami Electronics	53, 158-159
IGM, Div. NTI	188
Industrial Sciences, Inc.	52, 97, 180
Inovonics Inc.	116
International Tapetronics Corp.	16
Japan Electric Show	108
JVC Industries Inc.	70-71
Knox Ltd.	35
Laird Telemedia Inc.	192
Lenco Inc.	81
Listec Television Equip. Co.	139
Logitek Electronic Systems	188
Lowell Light	207
LPB Inc.	167
L-W International	195
Magna-Tech Electronic Co.	177
3M/Magnetic Tape Div.	37, 126
Marconi Electronics	93
Marconi Instruments	63
McCurdy Radio Ind. Inc.	C2, 88
McKay Dymek	117
McMartin Industries	200
Micro Consultants Inc.	152
Microtime	66
Micro-Trak	210
Modular Audio Products	187
Moseley Associates	191
NEC Broadcast Equipment	86-87
Rupert Neve, Inc.	13
Nippon Television Industry	207
Nova	204
Orange County Electronics	176
Orban Associates	95
Otari Corp.	149, 151, 153
Panasonic Matsushita Electric Corp.	45
Panasonic Technics	72
Philadelphia Resins	119

Philips Broadcast Equipment Corp.	110-111
Potomac Instruments	122, 206
Pro-Tech	209
QEI Corp.	156
QRK Electronic Products Inc.	137
Ramko Research	46-47
Rank Precision Industries, Inc.	157
RCA Broadcast Systems	40
Recortec	90
Rockwell International	165
RTS Systems Inc.	118
Russco Electronics Inc.	181
Saki Magnetics	187
Sharp Electronics	54-56
Shintron	156
Shure Bros. Inc.	85
Sintron Corp.	118
Skotel	136
Sonar Radio Corp.	186
Sony Corp. of America	4-5, 51
Sound Technology	27
Spin Physics	199
Stainless Inc.	102
Stanton Magnetics	203
Studio Film & Tape	210
System Concepts	20
Taber Mfg. & Eng. Co.	184
Tech Laboratories	205
Telemation	83, 163
Telemet	28
Television Products	154
Television Technology	204
Telex Communications Inc.	123
Tentel	206
TerraCom	155
Thomson-CSF Labs Inc.	15
Time & Frequency Technology Inc.	75
Toshiba Corp.	109
Tweed Audio	183
UMC Electronics Co.	14
UREI	107
Utah Scientific Inc.	60
Vega	31
Video Aids Corp. of Colorado	202
Videomax	3
Videomedia	115
Videotek Inc.	106
Viscount Industries Inc.	132
Wang Voice Communications	10
Ward-Beck Systems Ltd.	C4
Winsted Corp.	192
Yardney Electric Corp.	116
Yamaha International	103

PRODUCER/DIRECTOR

Immediate opening for qualified individual with B.A. in Communications, Radio-T.V., Journalism or related field and 3-5 years of "Hands-on" production experience directing production crews.

The setting is the King Faisal Specialist Hospital and Research Centre in Riyadh, the capital of Saudi Arabia. The Hospital is a 250 bed referral medical center with over 2000 employees from all over the world.

24-month married-status contract. salary and bonus \$30,000 + housing, vacations, transportation, etc.

Interested, qualified candidates should submit a resume with current salary to:

Pershing P. Stahlman
Hospital Corporation International

One Park Plaza, Nashville, Tennessee 37203
 1-800-251-2561
 1-800-342-2110 in Tenn.

AN EQUAL OPPORTUNITY EMPLOYER

NEW... THE 6618 CONSOLE

A SIX CHANNEL STEREO CONSOLE



18 inputs to 6 channels ...
 quiet pushbutton control ..
 long life panel
 plug in p.c. cards
 14 w. monitor amplifier

contact your Micro-Trak
 dealer or call 413 536-3551

MICRO-TRAK CORPORATION
 620 RACE STREET HOLYOKE, MASSACHUSETTS 01040

Circle 267 on Reader Service Card

30 DAYS NOTICE!

SEPTEMBER ONLY

2" QUAD

EVALUATED

Half \$55 each
 Hours

10 years of excellent prices and personal service.



**STUDIO
 FILM & TAPE INC.**

630 Ninth Avenue
 New York, N.Y. 10036
 (212) 977-9330

6670 Santa Monica Blvd.
 Hollywood, CA 90036
 (213) 466-8101

Circle 265 on Reader Service Card

BM/E READER SERVICE CARD September 1979 Issue

NAME _____
 TITLE _____
 STATION OR COMPANY _____
 ADDRESS _____
 CITY _____ STATE _____ ZIP _____
 PHONE # () _____

Tell us what you like or dislike about the issue

What articles would you like to see?

GREAT IDEA BALLOT <i>Fill in entry number of ideas you rank 1, 2, 3</i>					
No.	Rank	No.	Rank	No.	Rank
1		2		3	

100-249: ADS 250-399: EDITORIAL

100	101	102	103	104	105	106	107	108	109	110	111	112	113	114	115	116	117	118	119
120	121	122	123	124	125	126	127	128	129	130	131	132	133	134	135	136	137	138	139
140	141	142	143	144	145	146	147	148	149	150	151	152	153	154	155	156	157	158	159
160	161	162	163	164	165	166	167	168	169	170	171	172	173	174	175	176	177	178	179
180	181	182	183	184	185	186	187	188	189	190	191	192	193	194	195	196	197	198	199
200	201	202	203	204	205	206	207	208	209	210	211	212	213	214	215	216	217	218	219
220	221	222	223	224	225	226	227	228	229	230	231	232	233	234	235	236	237	238	239
240	241	242	243	244	245	246	247	248	249	250	251	252	253	254	255	256	257	258	259
260	261	262	263	264	265	266	267	268	269	270	271	272	273	274	275	276	277	278	279
280	281	282	283	284	285	286	287	288	289	290	291	292	293	294	295	296	297	298	299
300	301	302	303	304	305	306	307	308	309	310	311	312	313	314	315	316	317	318	319
320	321	322	323	324	325	326	327	328	329	330	331	332	333	334	335	336	337	338	339
340	341	342	343	344	345	346	347	348	349	350	351	352	353	354	355	356	357	358	359
360	361	362	363	364	365	366	367	368	369	370	371	372	373	374	375	376	377	378	379
380	381	382	383	384	385	386	387	388	389	390	391	392	393	394	395	396	397	398	399

Use until December 31, 1979

BM/E READER SERVICE CARD September 1979 Issue

NAME _____
 TITLE _____
 STATION OR COMPANY _____
 ADDRESS _____
 CITY _____ STATE _____ ZIP _____
 PHONE # () _____

Tell us what you like or dislike about the issue

What articles would you like to see?

GREAT IDEA BALLOT <i>Fill in entry number of ideas you rank 1, 2, 3</i>					
No.	Rank	No.	Rank	No.	Rank
1		2		3	

100-249: ADS 250-399: EDITORIAL

100	101	102	103	104	105	106	107	108	109	110	111	112	113	114	115	116	117	118	119
120	121	122	123	124	125	126	127	128	129	130	131	132	133	134	135	136	137	138	139
140	141	142	143	144	145	146	147	148	149	150	151	152	153	154	155	156	157	158	159
160	161	162	163	164	165	166	167	168	169	170	171	172	173	174	175	176	177	178	179
180	181	182	183	184	185	186	187	188	189	190	191	192	193	194	195	196	197	198	199
200	201	202	203	204	205	206	207	208	209	210	211	212	213	214	215	216	217	218	219
220	221	222	223	224	225	226	227	228	229	230	231	232	233	234	235	236	237	238	239
240	241	242	243	244	245	246	247	248	249	250	251	252	253	254	255	256	257	258	259
260	261	262	263	264	265	266	267	268	269	270	271	272	273	274	275	276	277	278	279
280	281	282	283	284	285	286	287	288	289	290	291	292	293	294	295	296	297	298	299
300	301	302	303	304	305	306	307	308	309	310	311	312	313	314	315	316	317	318	319
320	321	322	323	324	325	326	327	328	329	330	331	332	333	334	335	336	337	338	339
340	341	342	343	344	345	346	347	348	349	350	351	352	353	354	355	356	357	358	359
360	361	362	363	364	365	366	367	368	369	370	371	372	373	374	375	376	377	378	379
380	381	382	383	384	385	386	387	388	389	390	391	392	393	394	395	396	397	398	399

Use until December 31, 1979

COMPLIMENTARY SUBSCRIPTION QUALIFICATION CARD

1 I would like to receive BM/E (Broadcast Management Engineering)
 YES NO

2 Please check your business classifications

- | | |
|---|---|
| <input type="checkbox"/> AM Station Network Group
<input type="checkbox"/> FM Station Network Group
<input type="checkbox"/> TV Station Network Group
<input type="checkbox"/> Non broadcast TV
<input type="checkbox"/> Campus Limited Radio
<input type="checkbox"/> CATV Facilities
<input type="checkbox"/> Microwave Telephone
<input type="checkbox"/> Satellite Company | <input type="checkbox"/> Recording Studio
<input type="checkbox"/> Teleproduction Facility
<input type="checkbox"/> Government Consultant
<input type="checkbox"/> Lawyer
<input type="checkbox"/> Manufacturer Distributor Dealer
<input type="checkbox"/> Other (please specify) _____ |
|---|---|

3 Are you responsible for more than one station or facility?
 YES NO

4 My primary title is* (please check one)

- | | |
|---|---|
| <input type="checkbox"/> Corporate Management

<input type="checkbox"/> Technical Management & Engineering

<input type="checkbox"/> Operations & Station Management Production & Programming | Board Chairman President Owner Part ner Director and VP or General Manager (other than in charge of engineering or station operations management)

VP Engineering technical engineering director chief engineer engineering supervisor other engineering or technical titles

VP operations operation manager director general manager station manager production manager program manager news director and other operations titles |
|---|---|

5 Signature _____ Date _____

Name _____
 Title _____
 Station Call Letters or Company _____
 Street _____
 City _____ State _____ Zip _____

Is this your business address? YES NO

If not please give us your business address below so that we can avoid sending duplicate copies

Name _____
 Station Call Letters or Company _____
 Street _____
 City _____ State _____ Zip _____

Place
Postage
Here



Broadband Information Services, Inc.
P.O. BOX 6058
Duluth, Minnesota 55806

Place
Postage
Here



Broadband Information Services, Inc.
P.O. BOX 6058
Duluth, Minnesota 55806

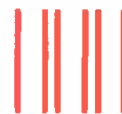

NO POSTAGE
NECESSARY
IF MAILED
IN THE
UNITED STATES

BUSINESS REPLY CARD
FIRST CLASS PERMIT NO. 665 DULUTH, MINNESOTA

POSTAGE WILL BE PAID BY ADDRESSEE



Broadband Information Services, Inc.
P. O. BOX 6056
Duluth, Minnesota 55806

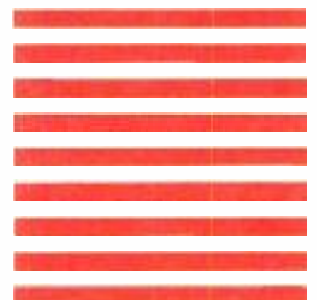

PHASER



A high performance full Frame Store TBC/Synchronizer with Freeze Frame for less than \$18,000.

We take pride in introducing the PHASER, a Frame Store TBC/Synchronizer that outperforms all the economy priced models on the market, and sells for less too.

The PHASER is a new "computer" technology system that uses software to save you money.

The PHASER offers many significant unique advantages.

- Multiple microprocessors and adaptive digital circuitry eliminate adjustments and mode switching.
- A clean "Hot Switch" between non-synchronous heterodyne and direct color signals, with full bandwidth processing.
- Automatic phase locking between multiple input signals and station reference.
- Horizontal and Vertical Blanking are never widened.
- A "smart" hands-off system that runs itself.
- The cleanest pictures anywhere.

Add to these the best features offered on competitive models, which we consider as standard, and you've got the PHASER, the undisputed leader in its class.

The PHASER is backed up by a network of conveniently located service centres, the most comprehensive warranty in the business, and a unique "No-Tweak" board exchange program when the initial one year warranty period is over.

Talk to your nearest authorized Digital dealer. He'll prove there is no other choice. Or ask us for full details: Digital Video Systems, 716 Gordon Baker Road, Willowdale, Ontario, Canada M2H 3B4. (416) 499-4826



DIGITAL

The digital video experts.

A scenic view of the Golden Gate Bridge in San Francisco, California, spanning across the water with hills in the background.

Ward-Beck is in the heart of San Francisco!

The magic of San Francisco is now
enhanced by new sound to
complement its scenic splendor.

Together... KRON and Ward-Beck.
The best, and getting better!

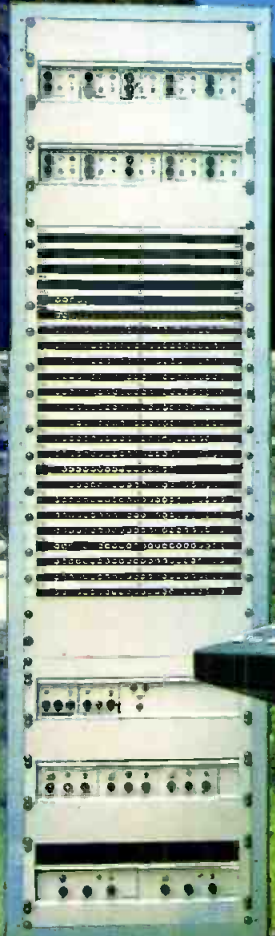

First by Design.

A tall, silver-colored rack-mounted television set with a large screen and various control panels at the top and bottom.

WBS Model 79005
KRON Television



Ward-Beck Systems Ltd., 1841 Progress Avenue, Scarborough, Ontario, Canada M1H 2X4.
Tel: (416) 438-6550.

Ward-Beck Systems Inc., 6900 East Camelback Road, Suite 1010, Scottsdale, Arizona 85251.